



The Global Language of Business

# Healthcare

Applying GS1 Standards for DSCSA and Traceability

## Addendum: Diagrams and XML Examples for Lot-Level Management Exceptions Processing

*Release 1.2, Nov 08 2016*

---



# Table of Contents

<b>1</b>	<b>Introduction .....</b>	<b>6</b>
1.1	Exception Scenarios in this Document.....	6
1.2	How to Use This Document.....	7
1.3	Exception Notification Process.....	7
1.4	Legend for Exception Processing Diagrams .....	8
1.5	The GS1 US DSCSA Implementation Suite.....	8
<b>2</b>	<b>Explicit Overage.....</b>	<b>9</b>
<b>3</b>	<b>Explicit Shortage.....</b>	<b>11</b>
<b>4</b>	<b>Lot Number Discrepancy (Homogeneous or Mixed Shipment) .....</b>	<b>13</b>
<b>5</b>	<b>Concealed Overage .....</b>	<b>15</b>
<b>6</b>	<b>Concealed Shortage .....</b>	<b>17</b>
<b>7</b>	<b>Incorrect Buyer “Sold to” Data .....</b>	<b>19</b>
<b>8</b>	<b>Incorrect Product Data .....</b>	<b>21</b>
<b>9</b>	<b>DSCSA (EPCIS) Data Not Received by Buyer.....</b>	<b>22</b>
<b>10</b>	<b>Damaged Shipment.....</b>	<b>23</b>
<b>11</b>	<b>DSCSA Data Incomplete.....</b>	<b>25</b>
<b>12</b>	<b>XML Examples.....</b>	<b>27</b>
12.1	Explicit Overage.....	27
12.1.1	Keep the Product.....	27
12.1.1.1	Sample XML: Exchange1 - Seller → Buyer.....	27
12.1.1.2	Sample XML: Buyer Receives Product (First Receipt) .....	29
12.1.1.3	Sample XML: Exchange2 - Seller → Buyer.....	31
12.1.1.4	Sample XML: Buyer Receives Product (2nd Receipt).....	33
12.1.2	Return or Refuse the Product .....	36
12.1.2.1	Sample XML: Exchange1 - Seller → Buyer.....	36
12.1.2.2	Sample XML: Buyer Receives Product .....	38
12.2	Explicit Shortage.....	41
12.2.1	Buyer Wants the Item .....	41
12.2.1.1	Sample XML: Exchange1 - Seller → Buyer.....	41
12.2.1.2	Sample XML: Buyer Receives Product (1st Receipt).....	43
12.2.1.3	Sample XML: Seller Corrects Shipment Data .....	45

12.2.1.4	Sample XML: Exchange2 - Seller → Buyer.....	47
12.2.1.5	Sample XML: Buyer Receives Product (2nd Receipt) .....	49
12.2.2	Buyer Cancels Item.....	52
12.2.2.1	Sample XML: Exchange1 - Seller → Buyer.....	52
12.2.2.2	Sample XML: Buyer Receives Product .....	54
12.2.2.3	Sample XML: Seller Corrects Shipment Data .....	57
12.3	Lot Number Discrepancy: Homogeneous or Mixed Shipment.....	60
12.3.1	Keep the Item .....	60
12.3.1.1	Sample XML: Exchange1 - Seller → Buyer.....	60
12.3.1.2	Sample XML: Buyer Receives Product (1st Receipt).....	62
12.3.1.3	Sample XML: Seller Corrects Shipment Data .....	64
12.3.1.4	Sample XML: Exchange2 - Seller → Buyer.....	66
12.3.1.5	Sample XML: Buyer Receives Product (2nd Receipt ) .....	68
12.3.2	Do Not Keep the Item .....	71
12.3.2.1	Sample XML: Exchange1 - Seller → Buyer.....	71
12.3.2.2	Sample XML: Buyer Receives Product .....	73
12.3.2.3	Sample XML: Seller Corrects Shipment Data .....	75
12.4	Concealed Overage .....	78
12.4.1	Keep the Extra Item.....	78
12.4.1.1	Sample XML: Exchange1 - Seller → Buyer.....	78
12.4.1.2	Sample XML: Buyer Receives Product (1st Receipt).....	80
12.4.1.3	Sample XML: Exchange2 - Seller → Buyer.....	82
12.4.1.4	Sample XML: Buyer Receives Product (2nd Receipt) .....	84
12.4.2	Return the Extra Item .....	87
12.4.2.1	Sample XML: Exchange1 - Seller → Buyer.....	87
12.4.2.2	Sample XML: Buyer Receives Product .....	89
12.5	Concealed Shortage .....	92
12.5.1	Have Current Order Fulfilled .....	92
12.5.1.1	Sample XML: Exchange1 - Seller → Buyer.....	92
12.5.1.2	Sample XML: Buyer Receives Product (1st Receipt).....	94
12.5.1.3	Sample XML: Seller Corrects Shipment Data .....	96
12.5.1.4	Sample XML: Exchange2 - Seller → Buyer.....	98
12.5.1.5	Sample XML: Buyer Receives Product (2nd Receipt) .....	101
12.5.2	Accept Items Physically Received – Cancel Missing Item .....	103
12.5.2.1	Sample XML: Exchange1 - Seller → Buyer.....	103
12.5.2.2	Sample XML: Buyer Receives Product (1st Receipt).....	105
12.5.2.3	Sample XML: Seller Corrects Shipment Data .....	108
12.6	Incorrect Buyer (Sold-to) .....	111
12.6.1	Sample XML: Exchange1 - Seller → Buyer.....	111
12.6.2	Sample XML: Seller Corrects Shipment Data .....	113
12.6.3	Sample XML: Exchange2 - Seller → Buyer.....	115
12.6.4	Sample XML: Buyer Receives Product.....	117

12.7	Incorrect Product Data.....	120
12.7.1	Sample XML: Exchange1 - Seller → Buyer.....	120
12.7.2	Sample XML: Seller Corrects Shipment Data .....	122
12.7.3	Sample XML: Exchange2 - Seller → Buyer.....	124
12.7.4	Sample XML: Buyer Receives Product.....	126
12.8	EPCIS Data Not Received By Buyer.....	129
12.8.1	Sample XML: Exchange1 - Seller → Buyer.....	129
12.8.2	Sample XML: Buyer Receives Product.....	131
12.9	Damage Shipment.....	134
12.9.1	Damaged Product is Returned to Seller.....	134
12.9.1.1	Sample XML: Exchange1 - Seller → Buyer.....	134
12.9.1.2	Sample XML: Buyer Receives Product .....	136
12.9.1.3	Sample XML: Exchange1 - Buyer → Seller.....	139
12.9.1.4	Sample XML: Seller Receives Returned Product .....	141
12.9.2	Damaged Product is Destroyed .....	143
12.9.2.1	Sample XML: Exchange1 - Seller → Buyer.....	143
12.9.2.2	Sample XML: Buyer Receives Product .....	145
12.9.2.3	Sample XML: Buyer Destroys Damaged Product .....	148
12.10	Incomplete DSCSA Data .....	151
12.10.1	Sample XML: Exchange1 - Seller → Buyer.....	151
12.10.2	Sample XML: Seller Corrects Shipment Data .....	153
12.10.3	Sample XML: Exchange2 - Seller → Buyer.....	155
12.10.4	Sample XML: Buyer Receives Product.....	157

## About GS1

GS1® is a neutral, not-for-profit, global organization that develops and maintains the most widely-used supply chain standards system in the world. GS1 Standards improve the efficiency, safety, and visibility of supply chains across multiple sectors. With local Member Organizations in over 110 countries, GS1 engages with communities of trading partners, industry organizations, governments, and technology providers to understand and respond to their business needs through the adoption and implementation of global standards. GS1 is driven by over a million user companies, which execute more than six billion transactions daily in 150 countries using GS1 Standards.

## About GS1 US

GS1 US®, a member of GS1 global, is a not-for-profit information standards organization that facilitates industry collaboration to improve supply chain visibility and efficiency through the use of GS1 Standards, the most widely-used supply chain standards system in the world. Nearly 300,000 businesses in 25 industries rely on GS1 US for trading-partner collaboration that optimizes their supply chains, drives cost performance and revenue growth while also enabling regulatory compliance. They achieve these benefits through solutions based on GS1 global unique numbering and identification systems, barcodes, Electronic Product Code-based RFID, data synchronization, and electronic information exchange. GS1 US also manages the United Nations Standard Products and Services Code® (UNSPSC®).

## About GS1 Healthcare

GS1 Healthcare is a global, voluntary healthcare user group developing global standards for the healthcare supply chain and advancing global harmonization. GS1 Healthcare consists of participants from all stakeholders of the healthcare supply chain: manufacturers, wholesalers, and distributors, as well as hospitals and pharmacy retailers. GS1 Healthcare also maintains close contacts with regulatory agencies and trade organizations worldwide. GS1 Healthcare drives the development of GS1 Standards and solutions to meet the needs of the global healthcare industry, and promotes the effective utilization and implementation of global standards in the healthcare industry through local support initiatives like GS1 Healthcare US® in the United States.

## About GS1 Healthcare US

GS1 Healthcare US® is an industry group that focuses on driving the adoption and implementation of GS1 Standards in the healthcare industry in the United States to improve patient safety and supply chain efficiency. GS1 Healthcare US brings together members from all segments of the healthcare industry to address the supply chain issues that most impact healthcare in the United States. Facilitated by GS1 US, GS1 Healthcare US is one of over 30 local GS1 Healthcare user groups around the world that supports the adoption and implementation of global standards developed by GS1.

# 1 Introduction

As the industry implements lot-level management for DSCSA, it is likely that exceptions regarding traceability-related data will occur early on. This document was developed by the GS1 Healthcare US Secure Supply Chain Task Force as a means to start assessing how supply chain partners might further leverage the EPCIS standard to address exceptions within supply chain business processes that impact lot-level management. It will be updated with additional insights into exception processing from actual implementations, pilots and healthcare visibility programs. The primary goal is to address those exceptions that are likely to occur during the transition to serialized products.

This document identifies each known exception, defines the impact on the trading partners, and depicts how the trading partners could use EPCIS to notify each other that an exception had occurred. Later versions of this document may go further to define the full choreography of messages or EPCIS events needed to resolve the exceptions. While this document provides examples of exception processing using the EPCIS standard, it is recognized that there are other methods (e.g., Electronic Data Interchange (EDI), etc.) that may be used by individual trading partners. The goal is to enable company systems to resolve exceptions with minimal human interaction by specifying EPCIS event choreographies that are aligned with the company's business rules and processes.

 **Note:** Each company is individually responsible for meeting all statutory and/or regulatory requirements for their company and their products. Consult with your company's legal counsel or compliance team (regulatory or quality) for more specific information about current statutory and regulatory requirements applicable to your company and products.

## 1.1 Exception Scenarios in this Document

To date, the GS1 Healthcare US Secure Supply Chain Task Force has identified the following list of lot-level exceptions that could occur:

- Explicit Overage
- Explicit Shortage
- Lot Number Discrepancy – Homogeneous or Mixed Shipment
- Concealed Overage
- Concealed Shortage
- Incorrect Buyer "Sold to" Data
- Incorrect Product Data
- DSCSA (EPCIS) Data Not Received by Buyer
- Damaged Shipment (case crushed, wet, etc.)
- DSCSA Data Incomplete

As these exceptions and their resolutions are documented, it may be that some have the same root cause and will be consolidated. Likewise, as pilots and implementations continue to inform the content of this guideline, other exceptions may be uncovered and documented in future releases.

 **Important:** Each company is individually responsible for meeting all statutory and/or regulatory requirements for their company and their products. Consult with your company's legal counsel or compliance team (regulatory or quality) for more specific information about statutory and regulatory requirements.

## 1.2 How to Use This Document

For each exception, this document provides: Business Process Steps, Diagram, and XML examples.

- Each exception is presented in its own chapter that includes the Business Process Steps and Diagram.
- The XML examples are provided in the last chapter. Use the bookmark provided in each exception chapter to navigate directly to the corresponding XML examples.

## 1.3 Exception Notification Process

In most cases, when a *Shipping* exception is discovered, the party making the discovery is the buyer. The initial notification of the discrepancy should follow today's existing methods as established with your trading partner. However, before the exception can be fully addressed, the buyer must inform the seller of the *details* of the exception. This will almost always require the buyer to provide the seller with one or more LGTINs (at a minimum)—that is, one or more Global Trade Item Numbers, plus the lot numbers associated with those GTINs. Because each GTIN plus lot will contain between 20 and 38 alpha-numeric characters, they should only be communicated between trading partners through **digital means**. Members of the supply chain should use one of the following ways for passing this information accurately:

- EPCIS events (standards for formatting and choreography of this type of data exchange will be included in a future version of the Implementation Guideline)
- Email, when only a few LGTINs are involved
- Electronic spreadsheet, when more than a few are involved
- Website (portal) offered by one of the parties that is dedicated to the exchange of this type of data (check with your trading partner)

These technologies allow both the buyer and the seller to make use of "copy-and-paste" for capturing the erroneous LGTINs and to perform the necessary investigation and resolution.

Technologies that should be **avoided** when communicating LGTINs involved in *Shipping* exceptions include:

- FAX
- Verbal (Telephone)
- Scanned PDF files
- Photocopies and photographs (except when additional documentation is needed)

The problem with these technologies is that they require too much interpretation by one or both parties. That is, someone must visually read (or listen) and then re-type all of the characters in the LGTINs. Re-typing LGTINs can too easily lead to errors that would compound the original error. In addition, when any of the recommended digital technologies are used, the ideal way to capture the needed LGTIN is by either copying-and-pasting from an EPCIS event, or by using a barcode reader to read the barcode from the product itself. The former will result in a "Uniform Resource Identifier," or "URI" format, and the latter will result in a GS1 "element string" format which will include the GTIN, lot number, and expiration date. Either of these should be accepted by your trading partner.



**Note:** For more about URI format and GS1 element string format, including examples, see the *GS1 US Implementation Guideline: Applying GS1 Standards for DSCSA and Traceability*.

## 1.4 Legend for Exception Processing Diagrams

**Figure 1-1** Exception Diagram Legend

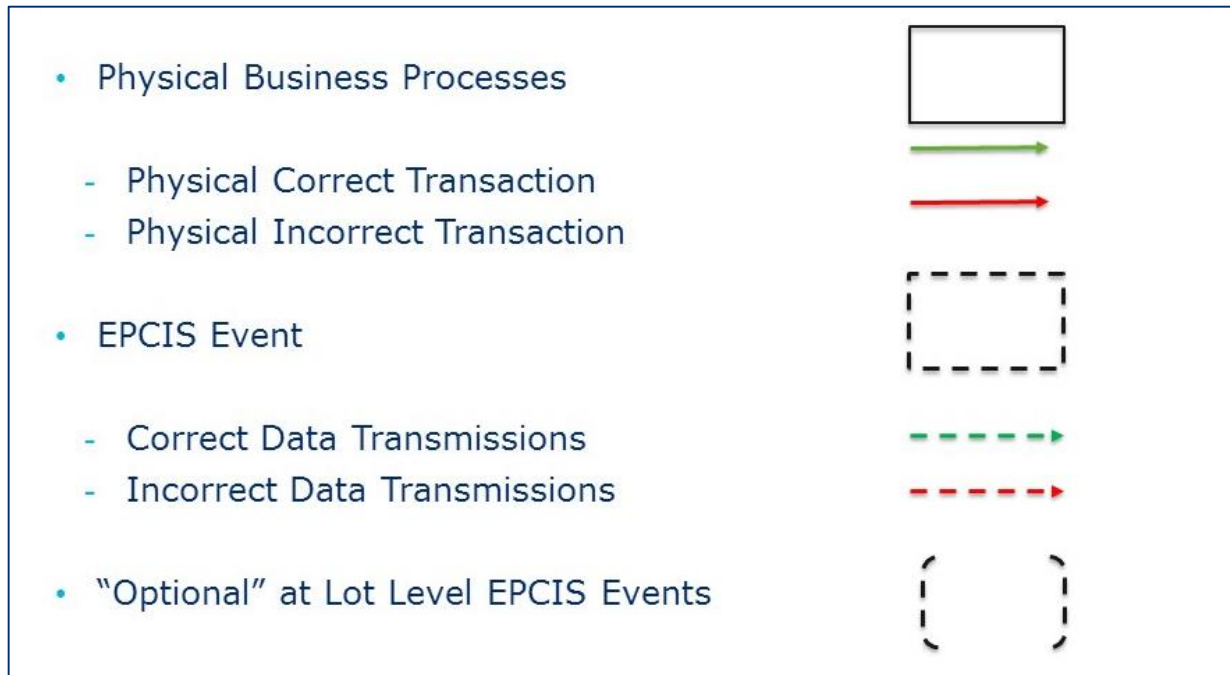

## 1.5 The GS1 US DSCSA Implementation Suite

To promote ease of use, the content for applying GS1 Standards to DSCSA and traceability has been split into four documents. All of these documents are available in the [GS1 US DSCSA Implementation Suite](#). The four documents in that suite are:

- *Implementation Guideline: Applying GS1 Standards for DSCSA and Traceability*
- *Addendum: Guidance and XML Examples for Supply Chain Choreographies in Lot-Level Management*
- *Addendum: Diagrams and XML Examples for Lot-Level Management Exceptions Processing*
- *Addendum: Diagrams and XML Examples for Serialized Exceptions Processing*



## 2 Explicit Overage

**Definition:** Buyer orders five cases, but six cases are delivered against that order. The EPCIS *Shipping* event documents five cases.

**XML examples:**

- [Explicit Overage – Buyer Keeps the Product](#)
- [Explicit Overage – Buyer Returns or Refuses the Product](#)

**Table 2-1** Explicit Overage Exception -- Resolution

Variation	Resolution Steps	Resolution
Buyer wants to keep the extra product.	<b>Manual intervention:</b>	Buyer retains the extra case, and Seller provides the additional DSCSA data to Buyer.
	1. Optional at Lot Level: the Buyer may process an EPCIS <i>Receiving</i> event to correspond with the Seller's <i>Shipping</i> event.	
	2. Buyer inventories the five cases that have DSCSA data, and quarantines the one case without DSCSA data.	
	3. Buyer makes Seller aware that the overage occurred and that the Buyer would like to keep the extra product.	
	4. Seller provides EPCIS <i>Shipping</i> event for one case. (Ship Date is original ship date and Transfer Date is date of new shipment.)	
	5. Buyer provides Seller order for one case.	
Buyer wants to return or refuse extra product.	<b>If Buyer recognizes the overage before the delivery truck leaves, Buyer can refuse delivery of the extra case. The remaining cases would be processed normally.</b>	Buyer either refuses delivery of extra case, or notifies Seller of issue and treats the case as a return item.
	1. Optional at Lot Level: the Buyer may process an EPCIS <i>Receiving</i> event to correspond with the Seller's <i>Shipping</i> event.	
	2. Five cases have DSCSA data and are inventoried and consumed.	
	3. Buyer makes Seller aware that the overage occurred.	
	4. The Buyer either: <ul style="list-style-type: none"> <li>■ refuses the extra case at the dock, or</li> <li>■ quarantines one case, and returns to the Seller.</li> </ul>	
5. Seller adjusts inventory if needed.		

**Figure 2-1** Exception Processing for an Explicit Overage – **Keep the Product**

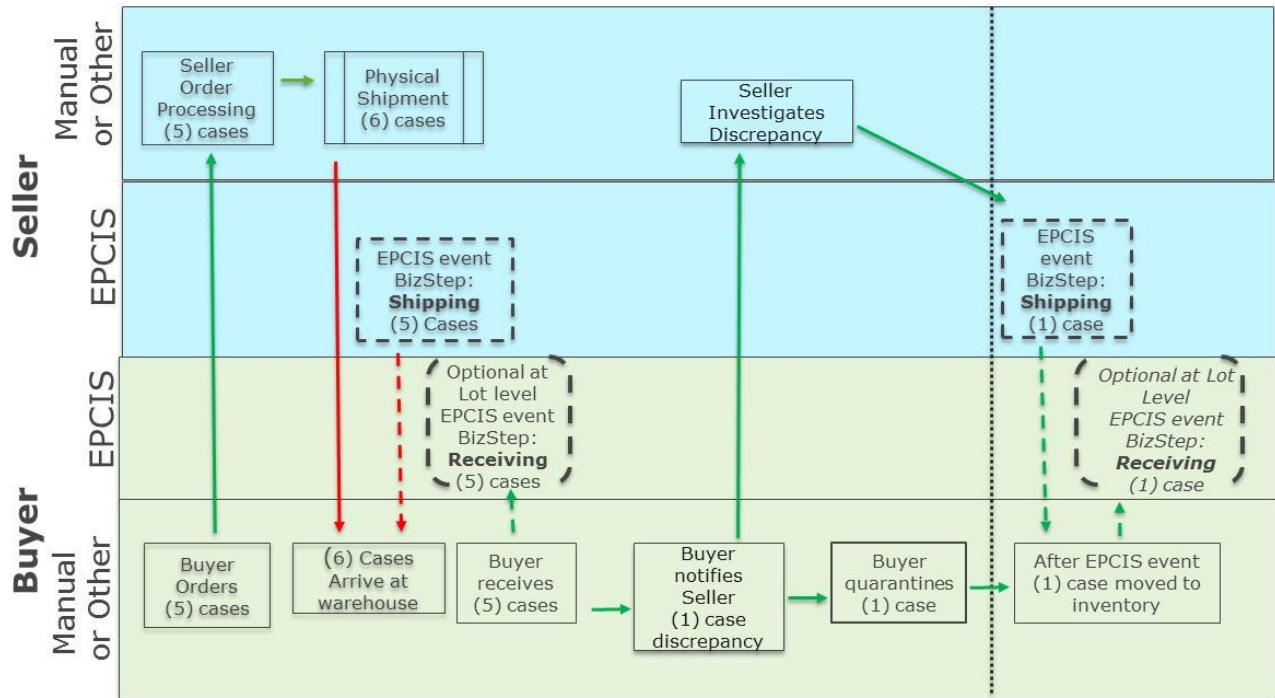

**Figure 2-2** Exception Processing for an Explicit Overage – **Refuse the Product**

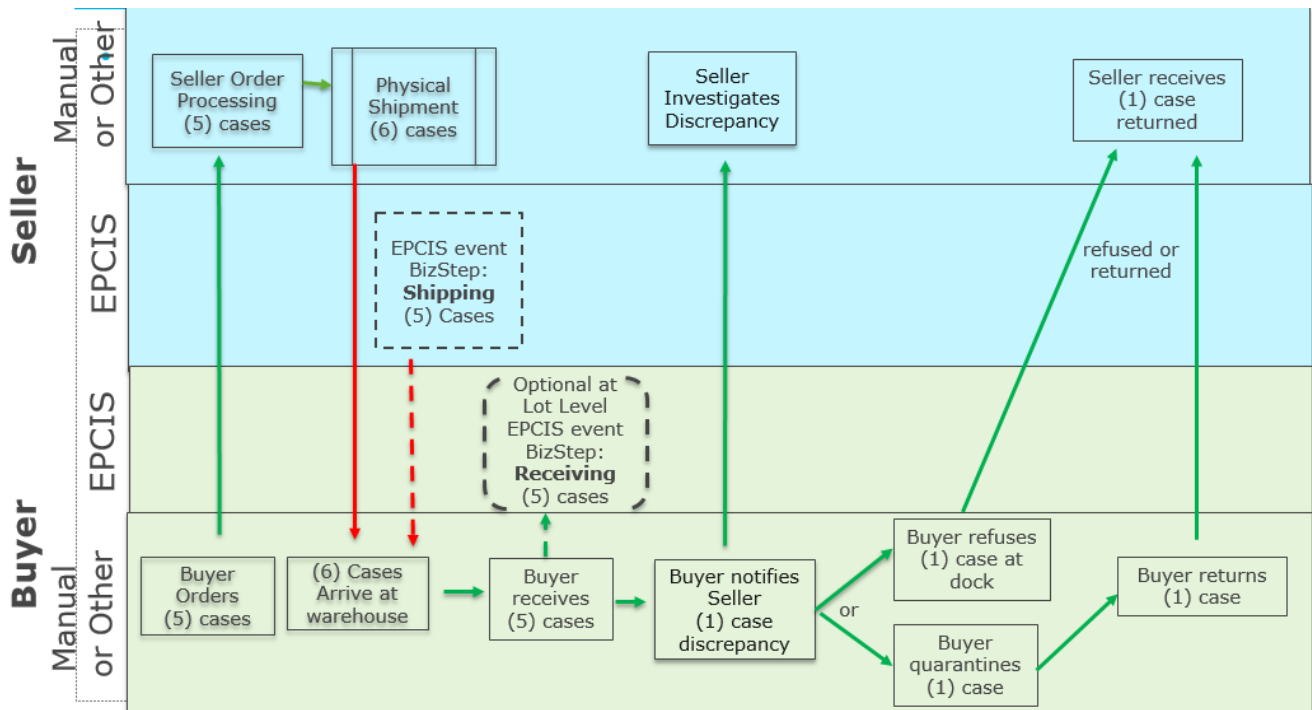

**Note:** Refusal at the buyer's dock before the carrier leaves is very rare.

### 3 Explicit Shortage

**Definition:** Buyer orders five cases, but four cases are delivered against that order. The EPCIS Shipping event documents four cases.

**XML examples:**

- [Explicit Shortage – Buyer Wants the Item](#)
- [Explicit Shortage – Buyer Cancels Item](#)

**Table 3-1** Explicit Shortage Exception – Resolution

Variation	Resolution Steps	Resolution
Buyer wants to have the current order fulfilled.	<b>Manual intervention:</b>	The Optional <i>VoidShipping</i> event explains that there was an error and removes the missing case from the DSCSA data feed. (Inventory now matches DSCSA data.)
	1. Buyer notifies Seller of shortage and of their desire to have the whole order fulfilled.	
	2. Optional at Lot level: the Seller may issue a <i>VoidShipping</i> event for the missing case.	
	3. Seller ships additional item against the original order along with a new <i>Shipping</i> event for the missing case.	
Buyer wants to cancel further shipments against the original order.	4. Buyer receives the case missing from the original order.	The Optional <i>VoidShipping</i> event explains that there was an error and removes the missing case from the DSCSA data feed. (Inventory now matches DSCSA data). The second shipment is processed normally.
	1. Buyer notifies Seller of shortage and of their desire to not have the whole order fulfilled.	
	2. Buyer makes adjustment to order in their system.	
	3. Optional at Lot level: the Seller may issue a <i>VoidShipping</i> event for the missing case.	

**Figure 3-1** Exception Processing for an Explicit Shortage – **Buyer Wants the Item**

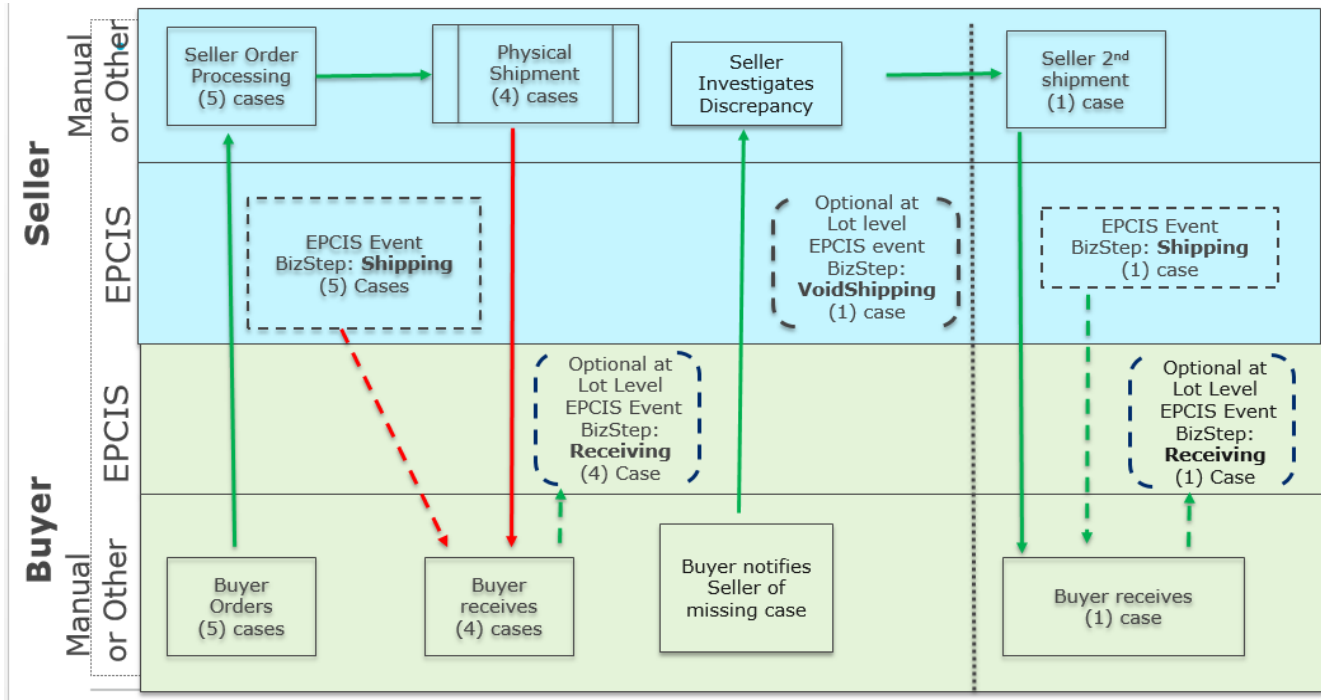

**Figure 3-2** Exception Processing for an Explicit Shortage – **Buyer Cancels the Item**

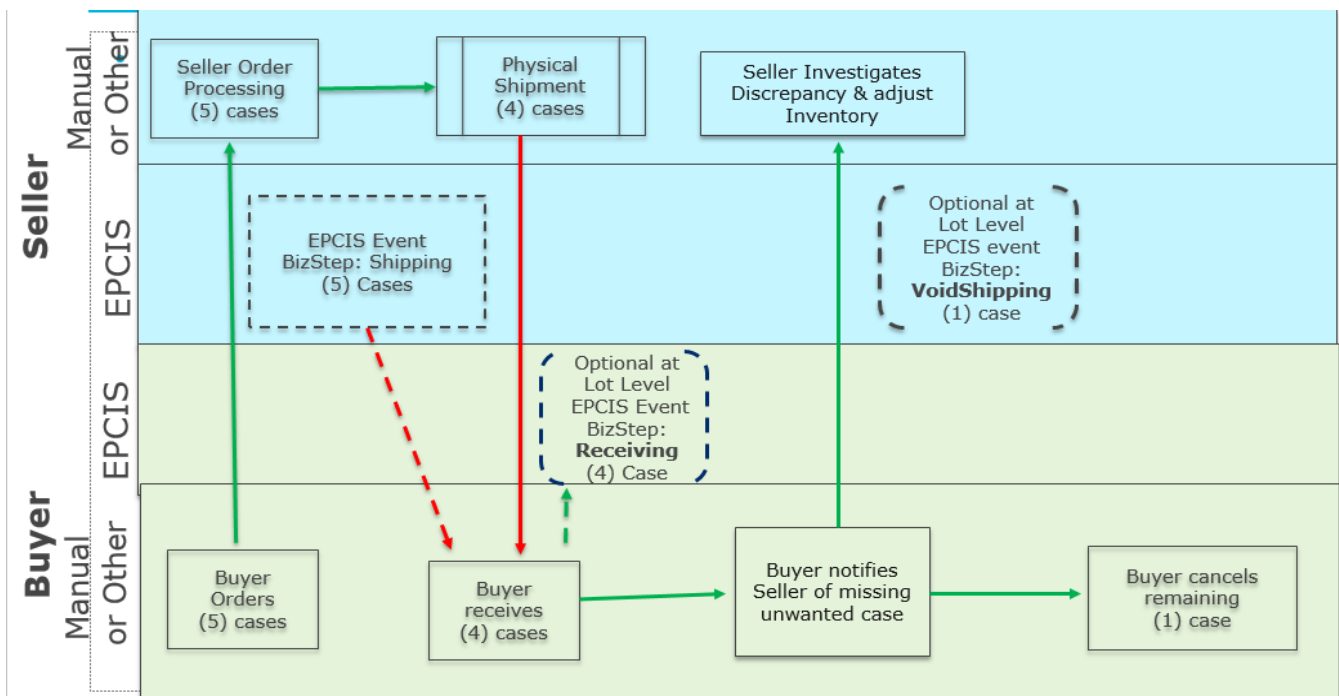

## 4 Lot Number Discrepancy (Homogeneous or Mixed Shipment)

**Definition:** Buyer orders five cases and five cases arrive; however, the lot number on two of the cases do not match the lot number on the EPCIS *Shipping* Event.

**XML examples:**

- [Lot Number Discrepancy – Buyer Wants to Keep the Item](#)
- [Lot Number Discrepancy – Buyer Wants to Return the Item](#)

**Table 4-1** Lot Number Discrepancy (Homogeneous or Mixed Shipment) Exception – Resolution

Variation	Resolution Steps	Resolution
Buyer wants to keep the items in the shipment.	<b>Manual intervention:</b>	At the Lot Level, the use of the Optional <i>VoidShipping</i> event allows the DSCSA data transfer to start over while also providing the proper data for an audit trail.
	1. Buyer notifies Seller of issue with the EPCIS data on two of the cases and of their desire to keep the items in the shipment.	
	2. Optional at Lot Level: the Seller issues a <i>VoidShipping</i> event for the two original items in the shipment.	
	3. Seller issues a corrected <i>Shipping</i> event for the two cases using the original dates.	
Buyer wants to return the items in the shipment.	4. Optional at the Lot level: the Buyer processes a <i>Receiving</i> event for the two cases for internal reconciliation.	At the Lot Level, the use of the Optional <i>VoidShipping</i> event allows the DSCSA data transfer to start over while also providing the proper data for an audit trail.
	<b>If Buyer recognizes the data discrepancy before the delivery truck leaves, Buyer can refuse delivery of the shipment.</b>	
	1. Buyer notifies Seller of issue with the EPCIS data and of their desire to return two of the cases in the shipment.	
	2. Optional at the Lot Level: Seller issues a <i>VoidShipping</i> event for the two original cases cases in the shipment.	

**Figure 4-1** Exception Processing for Lot Number Discrepancy  
(Homogeneous or Mixed Shipment) – **Keep Item**

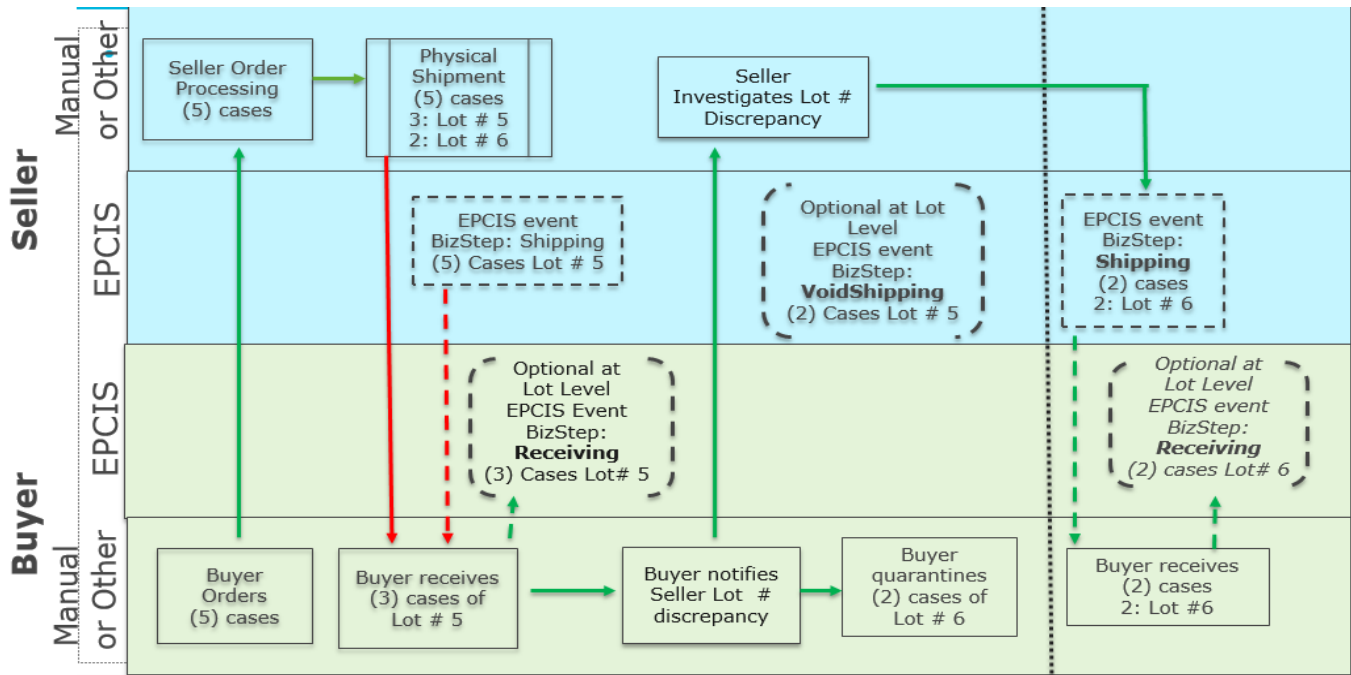

**Figure 4-2** Exception Processing for Lot Number Discrepancy  
(Homogeneous or Mixed Shipment) – **Do Not Keep Item**

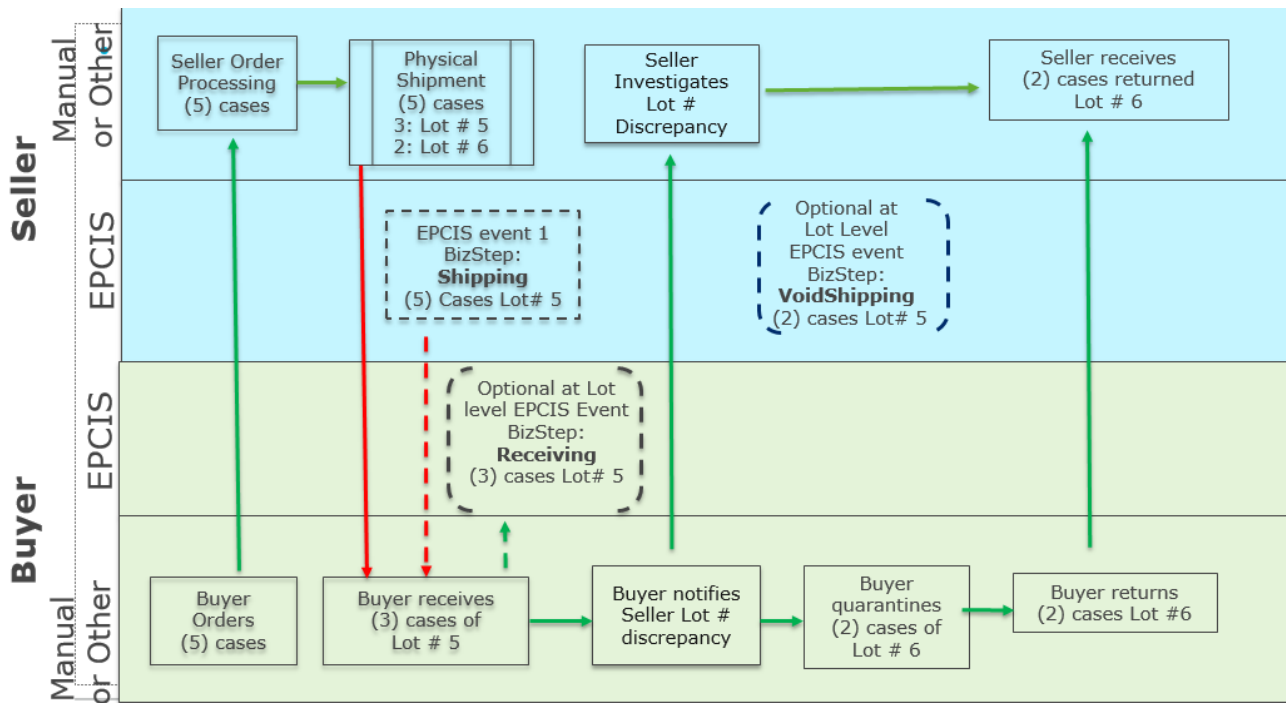

## 5 Concealed Overage

**Definition:** Buyer orders a case of 12. The case is received into inventory; however, when the case is opened, it is discovered that there are 13 in the case.

**XML examples:**

- [Concealed Overage – Buyer Keeps Extra Item](#)
- [Concealed Overage – Buyer Returns Extra Item](#)

**Table 5-1** Concealed Overage Exception -- Resolution

Variation	Resolution Steps	Resolution
<b>Buyer wants to keep the Extra Product.</b>	<b>Manual intervention:</b>	Buyer notifies Seller of the concealed overage and that they want to keep the item. Seller provides additional EPCIS <i>Shipping</i> event for the extra item originally received. Buyer retains extra item.
	1. Buyer receives the 1 case with an EPCIS <i>Shipping</i> event.	
	2. Upon opening the case, the Buyer makes Seller aware that the overage occurred and that the Buyer would like to keep the extra product.	
	3. Buyer quarantines the 1 item and provides Seller with an incremental order for the 1 item.	
	4. Seller provides an EPCIS <i>Shipping</i> event for 1 item. (Ship Date is the original ship date and Transfer Date is the date of new shipment.)	
	5. Optional: Buyer <i>Receiving</i> events for the original items and the incremental one.	
	6. Buyer transfers 1 item from quarantine to inventory.	
<b>Buyer wants to return the extra product.</b>	<b>The extra item is already in inventory, so the buyer can't refuse shipment. The other items have DSCSA data and can be processed normally.</b>	Buyer notifies Seller of the concealed overage and returns the unwanted item.
	1. Buyer receives the 1 case with an EPCIS <i>Shipping</i> event.	
	2. Upon opening the case, the Buyer makes Seller aware of the overage occurred and that the Buyer would like to return the product.	
	3. Buyer quarantines the 1 item and returns to the Seller.	
	4. Seller adjusts inventory if needed.	

**Figure 5-1** Exception Processing for a Concealed Overage -- **Keep the Extra Item**

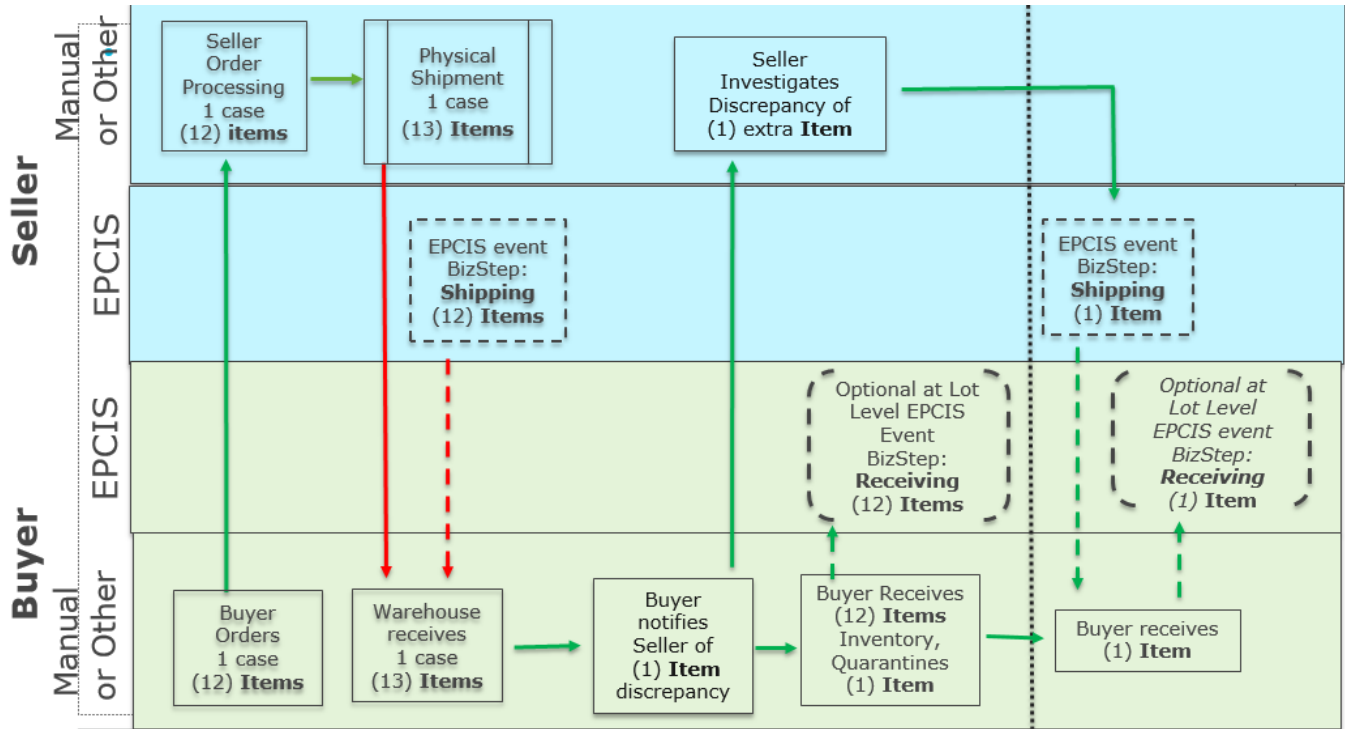

**Figure 5-2** Exception Processing for a Concealed Overage -- **Return the Extra Item**

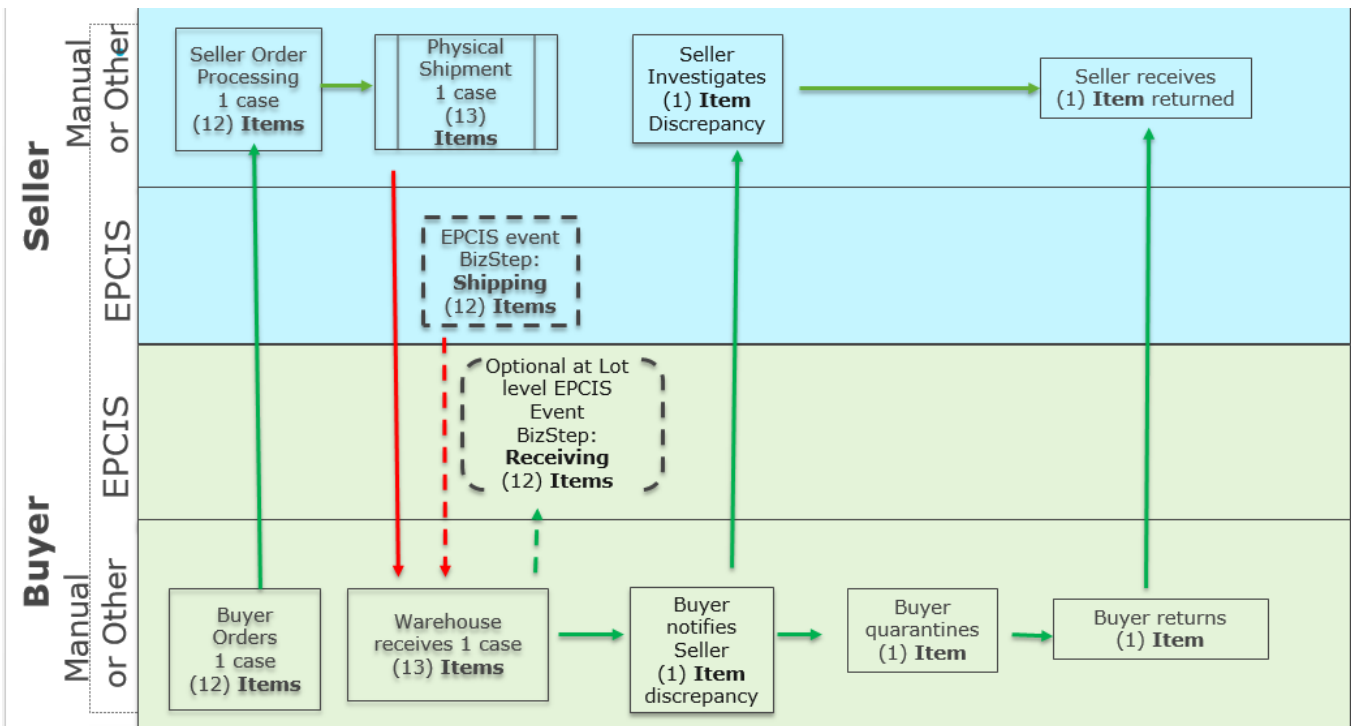



## 6 Concealed Shortage

**Definition:** Buyer orders one case of twelve items. EPCIS *Shipping* event documents twelve items. When case is opened, there are eleven items.

**XML examples:**

- [Concealed Shortage – Buyer Wants Order Fulfilled](#)
- [Concealed Shortage – Buyer Cancels Missing Item](#)

**Table 6-1** Concealed Shortage Exception -- Resolution

Variation	Resolution Steps	Resolution
Buyer wants to have the current order fulfilled.	<b>Manual intervention:</b>	<p>The Optional <i>VoidShipping</i> event explains that there was an error and removes the missing item from the DSCSA data feed. (Inventory now matches DSCSA data.) This allows the Buyer to use the 11 items in the original case.</p> <p>NOTE: An alternate method might be to void all items in the shipment and then for Seller to issue 2 new <i>Shipping</i> events: 1 for the original 11 items and 1 for the new item (with different Shipping Date). This alternative could delay the usage of the first 11 items in the case (until DSCSA arrives).</p>
	1. Seller ships 1 case with the corresponding EPCIS <i>Shipping</i> event for 1 case of 12 items.	
	2. After opening the case, Buyer notifies Seller of the shortage of 1 item from the case. The Buyer desires to have the whole order fulfilled by the missing item.	
	3. Seller issues an Optional <i>VoidShipping</i> event for the missing item and corrective <i>Shipping</i> event to account for the 11 items that arrived.	
	4. Seller ships additional item against the original order along with a new <i>Shipping</i> event for the missing item.	
5. Optional: Buyer records EPCIS event for <i>Receiving</i> .		
Buyer wants to cancel further shipments against the original order.	1. Seller ships 1 case with the corresponding EPCIS <i>Shipping</i> event for 1 case of 12 items.	<p>The Optional <i>VoidShipping</i> event explains that there was an error and removes the missing item from the DSCSA data feed. (Inventory now matches DSCSA data.)</p>
	2. After opening the case, the Buyer notifies Seller of the shortage of 1 item from the case. The Buyer desires to <u>not</u> have the whole order fulfilled.	
	3. Buyer makes adjustment to order in their system.	
	4. Seller may issue an Optional <i>VoidShipping</i> event for the missing 1 item and corrective <i>Shipping</i> event to account for the 11 items that were shipped.	

**Figure 6-1** Exception Processing for a Concealed Shortage – **Have Order Fulfilled**

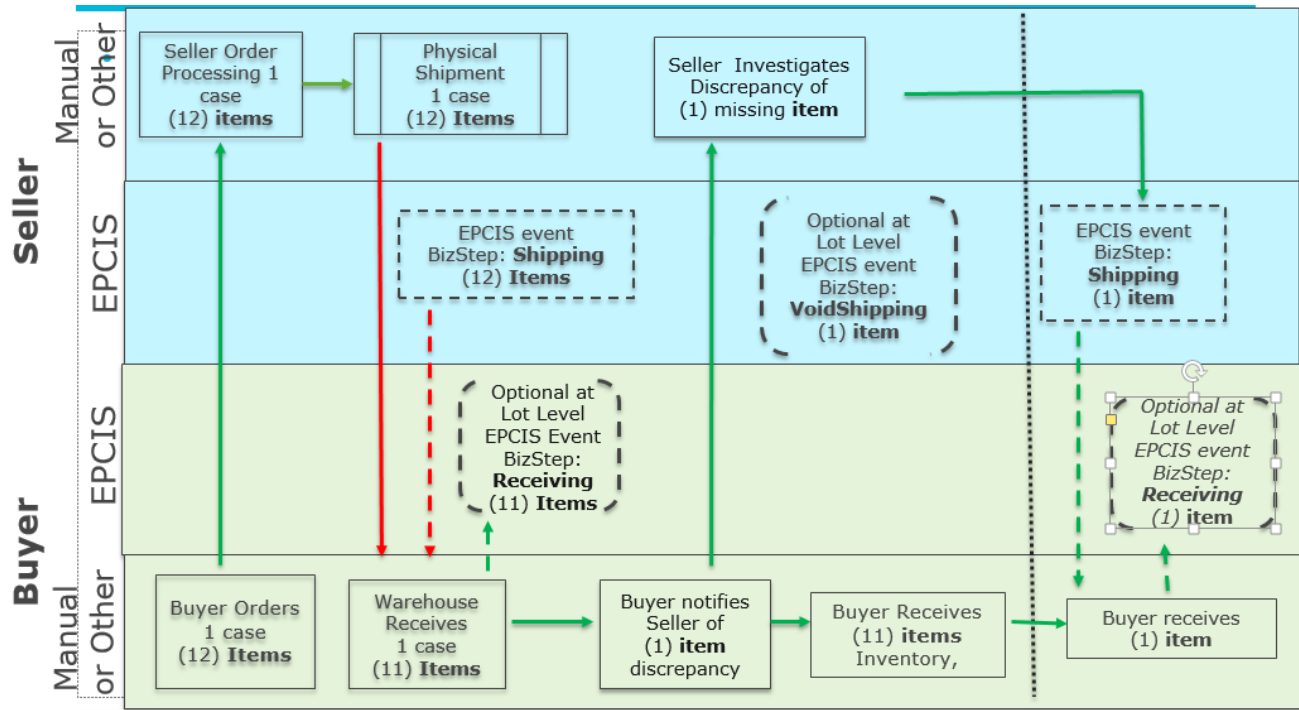

**Figure 6-2** Exception Processing for Concealed Shortage – **Accept Items Received, Cancel Additional Item**

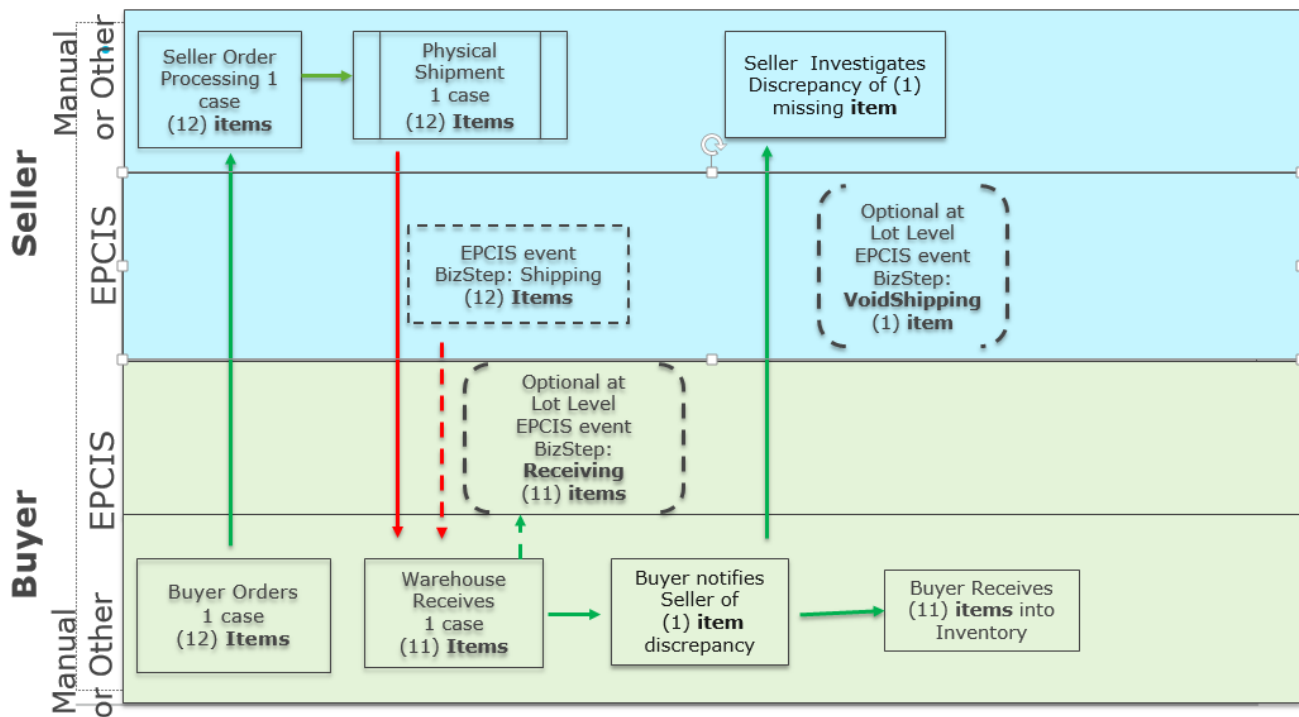

## 7 Incorrect Buyer “Sold to” Data

**Definition:** Seller ships correct shipment to the correct Buyer location/entity; however, the Buyer information in the EPCIS event is incorrect.

**XML examples:**

- [Incorrect Buyer “Sold to” Data](#)

**Table 7-1** Incorrect Buyer “Sold to” Data Exception -- Resolution

Variation	Resolution Steps	Resolution
None	<b>Manual intervention:</b>	The Optional <i>VoidShipping</i> event explains that there was an error and provides the proper balancing event to keep the EPCIS inventories or audit trail in agreement with other inventories.
	1. The EPCIS <i>Shipping</i> event contains incorrect Buyer “Sold to” information.	
	2. Buyer notifies Seller of issue.	
	3. At the Lot Level, the Seller may issue an Optional <i>VoidShipping</i> event for the entire shipment.	
	4. Seller issues a new <i>Shipping</i> event with correct Sold to entity information.	
5. Optional: Buyer creates an EPCIS <i>Receiving</i> event.		

**Figure 7-1** Exception Processing for Incorrect Buyer "Sold to" Data

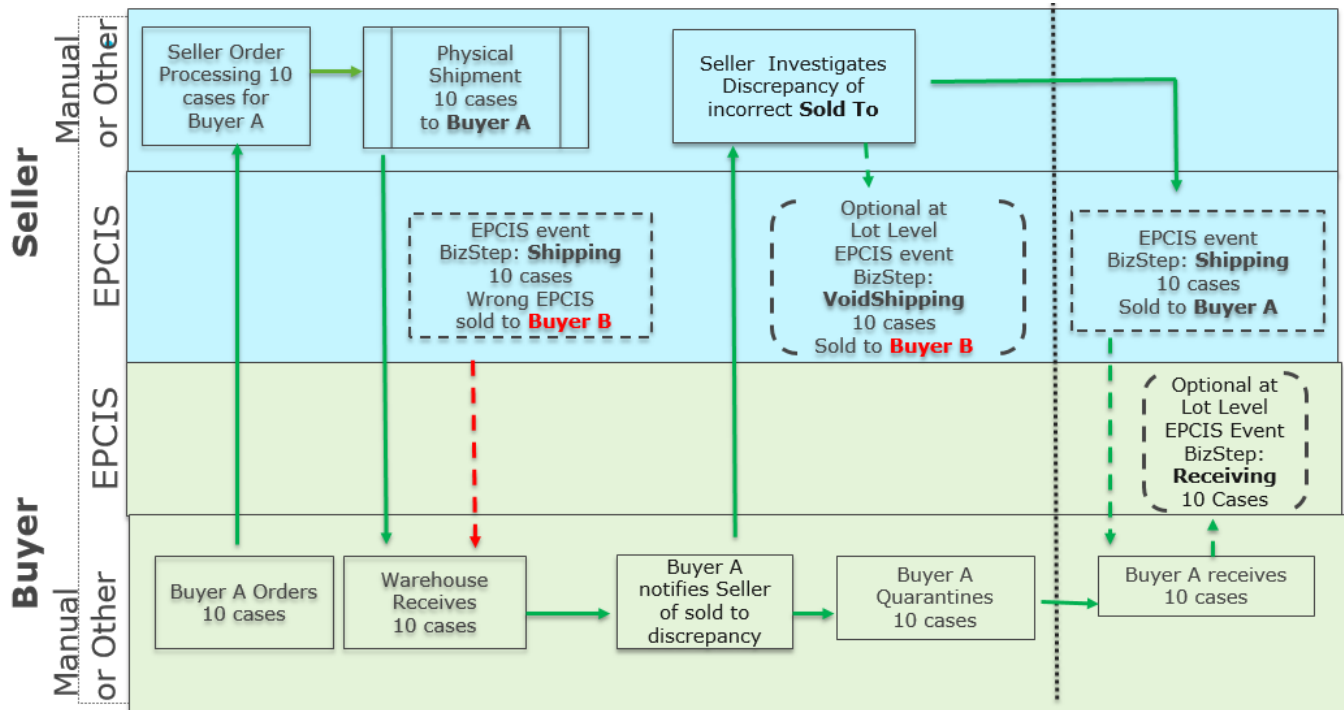

## 8 Incorrect Product Data

**Definition:** Seller physically ships the correct product to the Buyer; however, the product information in the EPCIS event is incorrect.

**XML examples:**

- [Incorrect Product Data](#)

**Table 8-1** Incorrect Product Data Exception -- Resolution

Variation	Resolution Steps	Resolution
None	<b>Manual intervention:</b>	<p>The Optional <i>VoidShipping</i> event explains that there was an error and provides the proper balancing event to keep the EPCIS inventories or audit trail in agreement with other inventories.</p> <p>NOTE: This scenario can be avoided if the trading partners are sharing product master data via another means such as the GDSN where product data is traded less frequently (only when it changes).</p>
	1. The EPCIS <i>Shipping</i> event contains the wrong product information.	
	2. Buyer notifies Seller of issue.	
	3. At the Lot Level, the Seller may issue an Optional <i>VoidShipping</i> event for the entire shipment.	
	4. Seller issues a new <i>Shipping</i> event with correct product information.	
5. Optional at Lot Level: Buyer creates an EPCIS <i>Receiving</i> event.		

**Figure 8-1** Exception Processing for Incorrect Product Data

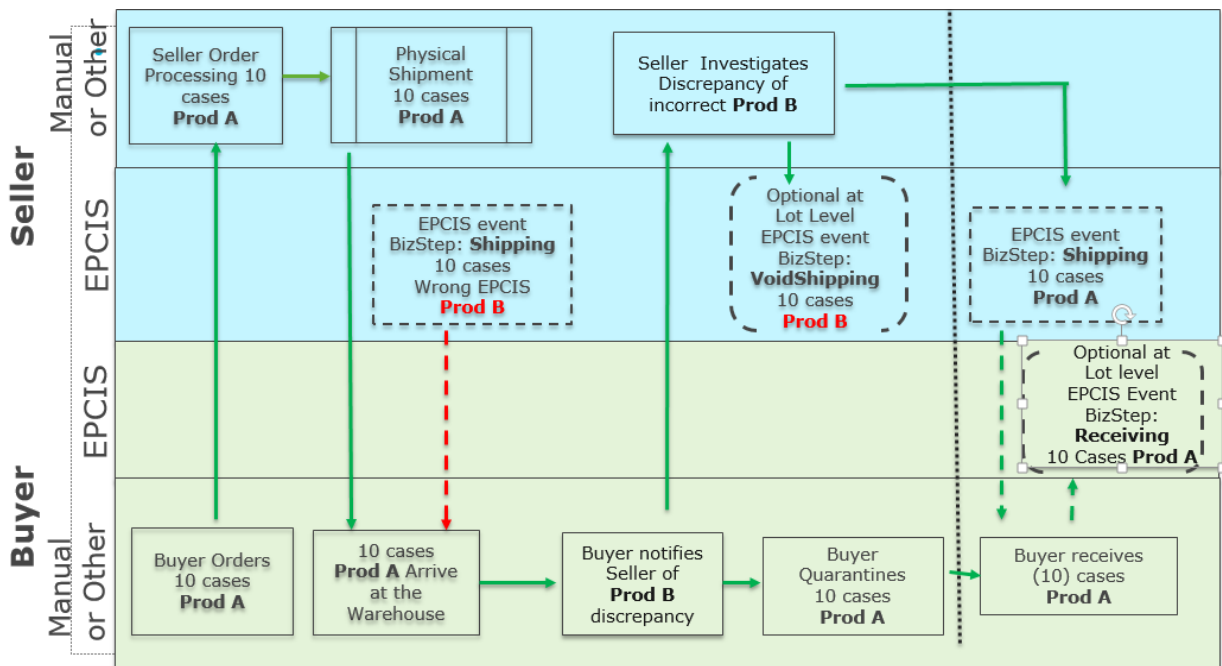

## 9 DSCSA (EPCIS) Data Not Received by Buyer

**Definition:** Seller ships correct shipment to the Buyer; however, the EPCIS XML for the DSCSA data does not arrive.

**XML examples:**

- [DSCSA Data Not Received by Buyer](#)

**Table 9-1** DSCSA Data Not Received by Buyer Exception -- Resolution

Variation	Resolution Steps	Resolution
None	<b>Manual intervention:</b>	NOTE: Buyer will experience delays while product is in quarantine awaiting proper DSCSA data.
	1. The Buyer receives ten cases of Product code A, but never receives the corresponding EPCIS <i>Shipping</i> event.	
	2. Buyer notifies the Seller of the issue.	
	3. Buyer quarantines the shipment.	
	4. Seller issues a new <i>Shipping</i> event with original shipping dates.	
	5. Optional at Lot level: Buyer creates an EPCIS <i>Receiving</i> event.	
6. Buyer transfers product from quarantine to inventory.		

**Figure 9-1** Exception Processing for DSCSA Data Not Received by Buyer

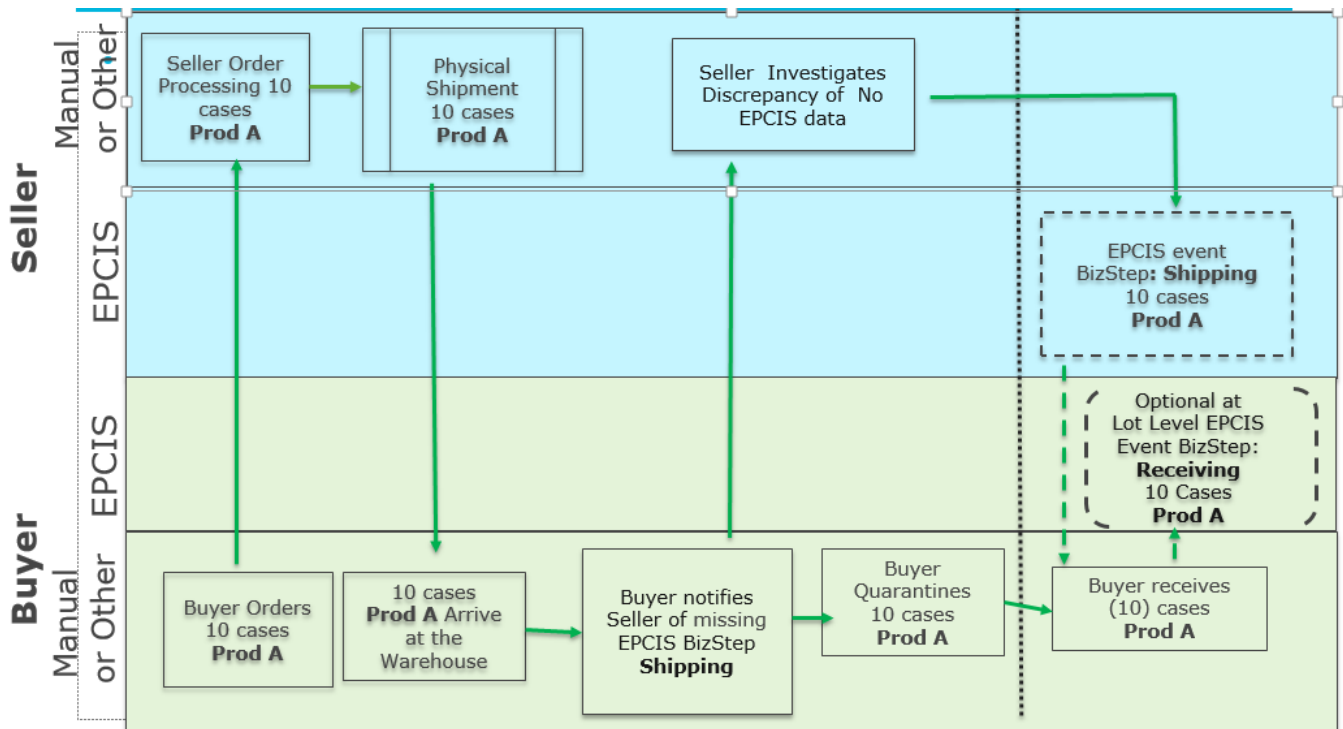

## 10 Damaged Shipment

**Definition:** Seller ships a 10 case shipment and the DSCSA transmission to the Buyer; however, one case arrives damaged (e.g., crushed, wet, etc.).

**XML examples:**

- [Damaged Shipment – Damaged Product is Returned](#)
- [Damaged Shipment – Damaged Product is Destroyed](#)

**Table 10-1** Damaged Shipment Exception -- Resolution

Variation	Resolution Steps	Resolution
<p><b>Buyer returns the damaged case and places a new order TO FULFILL the original order.</b></p>	<p><b>Manual intervention:</b></p>	<p>At the Lot Level, the Optional <i>Receiving</i> events of the entire order with separate dispositions of the good and damaged cases completes the DSCSA data feed. This allows the Buyer to use the 9 "good" cases from the order and return the 1 damaged case.</p> <p>NOTE: <i>This scenario (where the Buyer returns the damaged case) represents the vast majority of situations.</i></p>
	<p>1. Buyer notifies the Seller of the damaged case and of their desire to place a new order to fulfill the original order.</p>	
	<p>2. Buyer receives the entire order, dispositions the "good" cases, and quarantines the damage case.</p>	
	<p>3. Optional at Lot Level: Buyer processes two <i>Receiving</i> events with the dispositions of the cases.</p>	
	<p>4. Buyer returns the damaged case.</p>	
<p><b>Buyer destroys the damaged case at the seller's INSTRUCTIONS, AND places a new order TO FULFILL the original order.</b></p>	<p>5. The Buyer places a replacement order for (1) case.</p>	
	<p>1. Buyer notifies the Seller of the damaged case and of their desire to place a new order to fulfill the original order.</p>	<p>At the Lot Level, the Optional <i>Receiving</i> events of the entire order with separate dispositions of the good and damaged cases completes the DSCSA data feed. This allows the Buyer to use the 9 cases from the order, and destroy the 1 damaged case per the Seller's instructions.</p> <p>NOTE: <i>This scenario (where the Buyer destroys the damaged case on behalf of the Seller) rarely occurs.</i></p>
	<p>2. Buyer receives the entire order, dispositions the "good" cases, and quarantines the damaged case.</p>	
	<p>3. Optional at Lot Level: Buyer processes two <i>Receiving</i> events with the dispositions of the cases.</p>	
	<p>4. Seller instructs the Buyer to destroy the damaged case based on the low monetary value.</p>	
<p>5. Buyer processes an EPCIS <i>Destroy</i> event for the one case.</p>		

**Figure 10-1** Exception Processing for Damaged Shipment – **Buyer Returns Damaged Case**

**This scenario represents the vast majority of situations with damaged cases.**

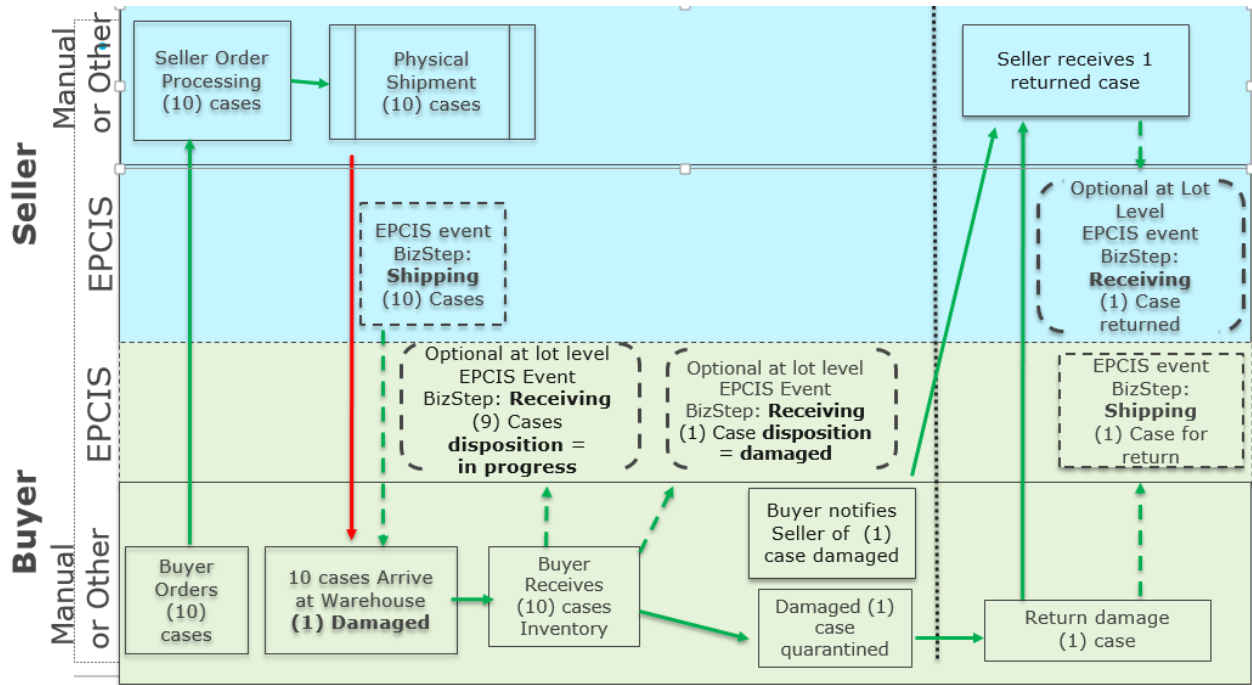

**Figure 10-2** Exception Processing for Damaged Shipment – **Buyer Destroys Damaged Case**

**This scenario rarely occurs.**

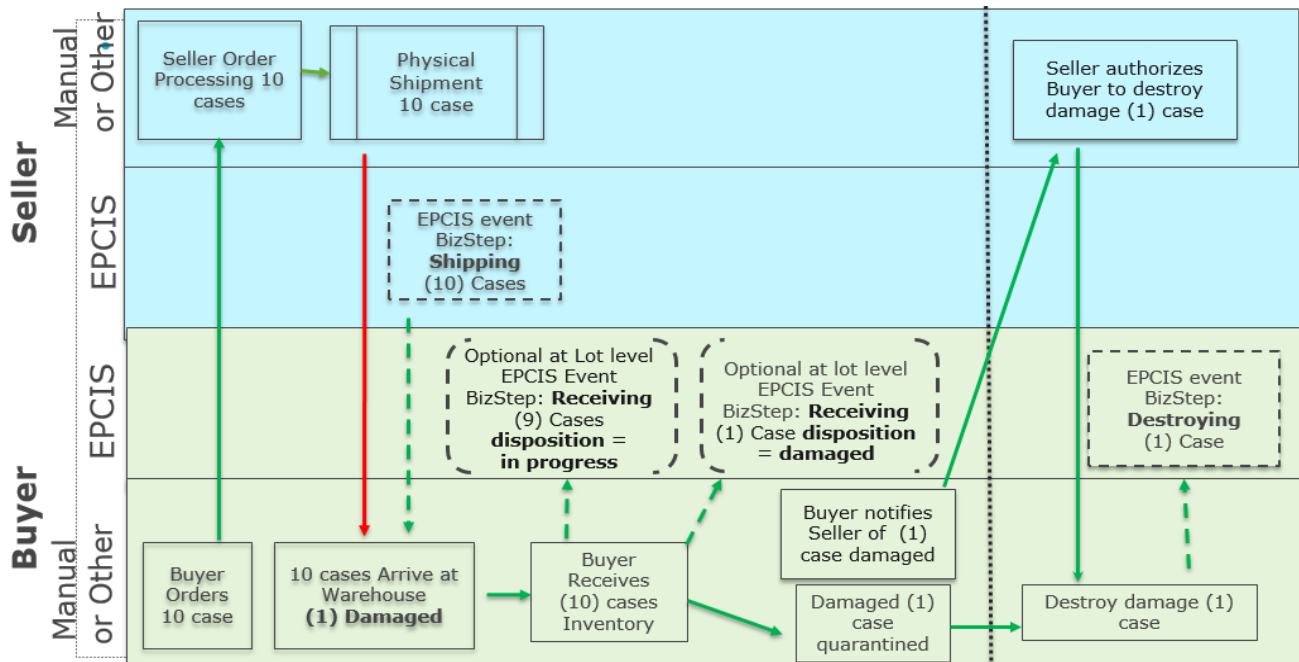



## 11 DSCSA Data Incomplete

**Definition:** Seller ships correct shipment and amounts to Buyer; however, not all DSCSA-required data was passed.

**XML examples:**

- [DSCSA Data Incomplete](#)

**Table 11-1** DSCSA Data Incomplete Exception -- Resolution

Variation	Resolution Steps	Resolution
None	<b>Manual intervention:</b>	Buyer will experience delays while the product is in quarantine awaiting proper DSCSA data. The Seller may issue a <i>VoidShipping</i> event. The Buyer may process an optional EPCIS <i>Receiving</i> event.
	1. The Seller ships the product to the Buyer, but the DSCSA data is incomplete.	
	2. Buyer notifies the Seller of the issue.	
	3. Buyer quarantines the shipment.	
	4. Optional at Lot Level: Seller issues a <i>VoidShipping</i> event for the entire shipment with the original shipping dates.	
	5. Seller issues a new <i>Shipping</i> event with all required data and the original shipping dates.	
	6. Buyer transfers product from quarantine to inventory.	
7. Optional at Lot Level: Buyer processes an EPCIS <i>Receiving</i> event.		

**Figure 11-1** Exception Processing for DSCSA Data Incomplete

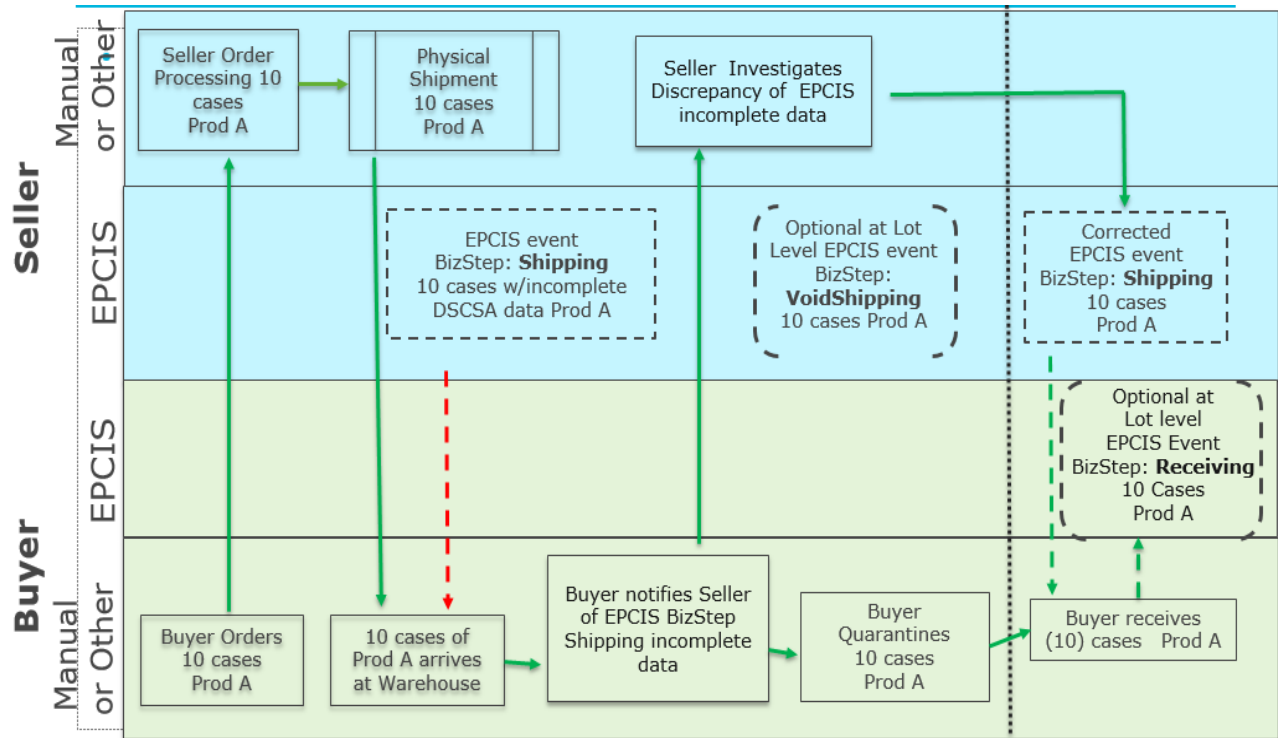

## 12 XML Examples

### 12.1 Explicit Overage

#### 12.1.1 Keep the Product

##### 12.1.1.1 Sample XML: Exchange1 - Seller → Buyer

Reference File: <https://resources.gs1us.org/Portals/0/xml/LotException-ExplicitOverageKeep-SellerExchange1.xml>

```
<?xml version="1.0" encoding="UTF-8"?>
<!-- Lot Exception: Explicit Overage (Keep) - Exchange1: Seller -> Buyer-->
<!-- Seller physically ships 6 cases by mistake. Seller's IT system reflects only 5 cases were
shipped. -->
<epcis:EPCISDocument xmlns:cbvmda="urn:epcglobal:cbv:mda"
xmlns:sbdh="http://www.unece.org/cefact/namespaces/StandardBusinessDocumentHeader"
xmlns:gs1ushc="http://epcis.gs1us.org/hc/ns" xmlns:epcis="urn:epcglobal:epcis:xsd:1"
schemaVersion="1.2" xsi:schemaLocation="urn:epcglobal:epcis:xsd:1 EPCglobal-epcis-1_2.xsd"
xmlns:xsi="http://www.w3.org/2001/XMLSchema-instance" creationDate="2014-04-01T15:14:27.574-
04:00">
  <EPCISHeader>
    <sbdh:StandardBusinessDocumentHeader>
      <sbdh:HeaderVersion>1.0</sbdh:HeaderVersion>
      <sbdh:Sender>
        <sbdh:Identifier
Authority="SGLN">urn:epc:id:sgln:030000.000000.0</sbdh:Identifier>
        </sbdh:Sender>
        <sbdh:Receiver>
          <sbdh:Identifier
Authority="SGLN">urn:epc:id:sgln:0614141.00000.0</sbdh:Identifier>
          </sbdh:Receiver>
          <sbdh:DocumentIdentification>
            <sbdh:Standard>EPCglobal</sbdh:Standard>
            <sbdh:TypeVersion>1.0</sbdh:TypeVersion>
            <sbdh:InstanceIdentifier>1234567890</sbdh:InstanceIdentifier>
            <sbdh:Type>Events</sbdh:Type>
            <sbdh:CreationDateAndTime>2014-04-01T15:14:27.574-04:00</sbdh:CreationDateAndTime>
          </sbdh:DocumentIdentification>
        </sbdh:StandardBusinessDocumentHeader>
        <extension>
          <EPCISMasterData>
            <VocabularyList>
              <Vocabulary type="urn:epcglobal:epcis:vtype:EPCClass">
                <VocabularyElementList>
                  <VocabularyElement id="urn:epc:class:lgtn:030000.0000001.L1">
                    <attribute id="urn:epcglobal:cbv:mda#itemExpirationDate">2017-10-
31</attribute>
                  </VocabularyElement>
                  <VocabularyElement id="urn:epc:idpat:sgtin:030000.0000001.*">
                    <attribute
id="urn:epcglobal:cbv:mda#additionalTradeItemIdentification">00000000001</attribute>
                    <attribute
id="urn:epcglobal:cbv:mda#additionalTradeItemIdentificationTypeCode">FDA_NDC_11</attribute>
                    <attribute
id="urn:epcglobal:cbv:mda#regulatedProductName">Epcistra</attribute>
```

```

        <attribute
id="urn:epcglobal:cbv:mda#manufacturerOfTradeItemPartyName">GS1 Pharma LLC</attribute>
        <attribute id="urn:epcglobal:cbv:mda#dosageFormType">PILL</attribute>
        <attribute
id="urn:epcglobal:cbv:mda#strengthDescription">100mg</attribute>
        <attribute id="urn:epcglobal:cbv:mda#netContentDescription">500
pills</attribute>
    </VocabularyElement>
</VocabularyElementList>
</Vocabulary>
<Vocabulary type="urn:epcglobal:epcis:vtype:Location">
    <VocabularyElementList>
        <VocabularyElement id="urn:epc:id:sgln:030000.000000.0">
            <attribute id="urn:epcglobal:cbv:mda#name">GS1 Pharma LLC</attribute>
            <attribute id="urn:epcglobal:cbv:mda#streetAddressOne">1295 S George
Ave</attribute>
            <attribute id="urn:epcglobal:cbv:mda#streetAddressTwo">Room
378</attribute>
            <attribute id="urn:epcglobal:cbv:mda#city">Washington</attribute>
            <attribute id="urn:epcglobal:cbv:mda#state">DC</attribute>
            <attribute id="urn:epcglobal:cbv:mda#postalCode">12345-
6789</attribute>
            <attribute id="urn:epcglobal:cbv:mda#countryCode">US</attribute>
        </VocabularyElement>
        <VocabularyElement id="urn:epc:id:sgln:0614141.00000.0">
            <attribute id="urn:epcglobal:cbv:mda#name">GS1 Drug Distro
LLC</attribute>
            <attribute id="urn:epcglobal:cbv:mda#streetAddressOne">230 Park Ave
S</attribute>
            <attribute id="urn:epcglobal:cbv:mda#city">New York</attribute>
            <attribute id="urn:epcglobal:cbv:mda#state">NY</attribute>
            <attribute id="urn:epcglobal:cbv:mda#postalCode">10003-
1502</attribute>
            <attribute id="urn:epcglobal:cbv:mda#countryCode">US</attribute>
        </VocabularyElement>
    </VocabularyElementList>
</Vocabulary>
</VocabularyList>
</EPCISMasterData>
</extension>
<gslushc:dcsaTransactionStatement>
    <gslushc:affirmTransactionStatement>true</gslushc:affirmTransactionStatement>
    <gslushc:legalNotice>Seller has complied with each applicable subsection of FDCA Sec.
581 (27) (A) – (G).</gslushc:legalNotice>
</gslushc:dcsaTransactionStatement>
</EPCISHeader>
<EPCISBody>
    <EventList>
        <!-- Transaction Information (TI) -->
        <ObjectEvent>
            <eventTime>2014-04-01T10:11:12Z</eventTime>
            <eventTimeZoneOffset>-05:00</eventTimeZoneOffset>
            <epcList/>
            <action>OBSERVE</action>
            <bizStep>urn:epcglobal:cbv:bizstep:shipping</bizStep>
            <disposition>urn:epcglobal:cbv:disp:in_transit</disposition>
            <readPoint>
                <id>urn:epc:id:sgln:030000.000000.0</id>
            </readPoint>
            <extension>
                <quantityList>

```

```

        <!-- In this example, the EPCIS quantityElement data
structure contains the lgtin for the lowest saleable unit (LSU) and the quantity value is given
in terms of LSUs. For this example scenario, each ordered case contains 12 LSUs. Hence, the
quantity value will be computed by multiplying the order case quantity with 12 LSUs. -->
        <quantityElement>
            <epcClass>urn:epc:class:lgtin:030000.0000001.L1</epcClass>
            <quantity>60</quantity>
        </quantityElement>
    </quantityList>
    <sourceList>
        <source
type="urn:epcglobal:cbv:sdt:owning_party">urn:epc:id:sgln:030000.000000.0</source>
    </sourceList>
    <destinationList>
        <destination
type="urn:epcglobal:cbv:sdt:owning_party">urn:epc:id:sgln:0614141.00000.0</destination>
    </destinationList>
</extension>
</ObjectEvent>
</EventList>
</EPCISBody>
</epcis:EPCISDocument>

```

### 12.1.1.2 Sample XML: Buyer Receives Product (First Receipt)

Reference File: <https://resources.gs1us.org/Portals/0/xml/LotException-ExplicitOverageKeep-BuyerReceives-1st.xml>

```

<?xml version="1.0" encoding="UTF-8"?>
<!-- Lot Exception: Explicit Overage (Keep) - Buyer Receives Product (First Receipt) -->
<!-- Buyer receives 5 cases with supporting DSCSA data -->
<epcis:EPCISDocument xmlns:cbvmda="urn:epcglobal:cbv:mda"
xmlns:sbdh="http://www.unece.org/cefact/namespaces/StandardBusinessDocumentHeader"
xmlns:gslushc="http://epcis.gs1us.org/hc/ns" xmlns:epcis="urn:epcglobal:epcis:xsd:1"
schemaVersion="1.2" xsi:schemaLocation="urn:epcglobal:epcis:xsd:1 EPCglobal-epcis-1_2.xsd"
xmlns:xsi="http://www.w3.org/2001/XMLSchema-instance" creationDate="2014-04-02T15:14:27.574-
04:00">
    <EPCISHeader>
        <sbdh:StandardBusinessDocumentHeader>
            <sbdh:HeaderVersion>1.0</sbdh:HeaderVersion>
            <sbdh:Sender>
                <sbdh:Identifier
Authority="SGLN">urn:epc:id:sgln:0614141.00000.0</sbdh:Identifier>
            </sbdh:Sender>
            <sbdh:Receiver>
                <sbdh:Identifier
Authority="SGLN">urn:epc:id:sgln:0614141.11111.0</sbdh:Identifier>
            </sbdh:Receiver>
            <sbdh:DocumentIdentification>
                <sbdh:Standard>EPCglobal</sbdh:Standard>
                <sbdh:TypeVersion>1.0</sbdh:TypeVersion>
                <sbdh:InstanceIdentifier>1234567891</sbdh:InstanceIdentifier>
                <sbdh:Type>Events</sbdh:Type>
                <sbdh:CreationDateAndTime>2014-04-02T15:14:27.574-04:00</sbdh:CreationDateAndTime>
            </sbdh:DocumentIdentification>
        </sbdh:StandardBusinessDocumentHeader>
    <extension>
        <EPCISMasterData>
            <VocabularyList>
                <Vocabulary type="urn:epcglobal:epcis:vtype:EPCClass">

```

```

    <VocabularyElementList>
      <VocabularyElement id="urn:epc:class:lgtn:030000.0000001.L1">
        <attribute id="urn:epcglobal:cbv:mda#itemExpirationDate">2017-10-
31</attribute>
      </VocabularyElement>
      <VocabularyElement id="urn:epc:idpat:sgtin:030000.0000001.*">
        <attribute
id="urn:epcglobal:cbv:mda#additionalTradeItemIdentification">00000000001</attribute>
        <attribute
id="urn:epcglobal:cbv:mda#additionalTradeItemIdentificationTypeCode">FDA_NDC_11</attribute>
        <attribute
id="urn:epcglobal:cbv:mda#regulatedProductName">Epcistra</attribute>
        <attribute
id="urn:epcglobal:cbv:mda#manufacturerOfTradeItemPartyName">GS1 Pharma LLC</attribute>
        <attribute id="urn:epcglobal:cbv:mda#dosageFormType">PILL</attribute>
        <attribute
id="urn:epcglobal:cbv:mda#strengthDescription">100mg</attribute>
        <attribute id="urn:epcglobal:cbv:mda#netContentDescription">500
pills</attribute>
      </VocabularyElement>
    </VocabularyElementList>
  </Vocabulary>
  <Vocabulary type="urn:epcglobal:epcis:vtype:Location">
    <VocabularyElementList>
      <VocabularyElement id="urn:epc:id:sgln:030000.000000.0">
        <attribute id="urn:epcglobal:cbv:mda#name">GS1 Pharma LLC</attribute>
        <attribute id="urn:epcglobal:cbv:mda#streetAddressOne">1295 S George
Ave</attribute>
        <attribute id="urn:epcglobal:cbv:mda#streetAddressTwo">Room
378</attribute>
        <attribute id="urn:epcglobal:cbv:mda#city">Washington</attribute>
        <attribute id="urn:epcglobal:cbv:mda#state">DC</attribute>
        <attribute id="urn:epcglobal:cbv:mda#postalCode">12345-
6789</attribute>
        <attribute id="urn:epcglobal:cbv:mda#countryCode">US</attribute>
      </VocabularyElement>
      <VocabularyElement id="urn:epc:id:sgln:0614141.00000.0">
        <attribute id="urn:epcglobal:cbv:mda#name">GS1 Drug Distro
LLC</attribute>
        <attribute id="urn:epcglobal:cbv:mda#streetAddressOne">230 Park Ave
S</attribute>
        <attribute id="urn:epcglobal:cbv:mda#city">New York</attribute>
        <attribute id="urn:epcglobal:cbv:mda#state">NY</attribute>
        <attribute id="urn:epcglobal:cbv:mda#postalCode">10003-
1502</attribute>
        <attribute id="urn:epcglobal:cbv:mda#countryCode">US</attribute>
      </VocabularyElement>
    </VocabularyElementList>
  </Vocabulary>
</VocabularyList>
</EPCISMasterData>
</extension>
</EPCISHeader>
<EPCISBody>
  <EventList>
    <ObjectEvent>
      <eventTime>2014-04-02T10:11:12Z</eventTime>
      <eventTimeZoneOffset>-05:00</eventTimeZoneOffset>
      <epcList/>
      <action>OBSERVE</action>
      <bizStep>urn:epcglobal:cbv:bizstep:receiving</bizStep>
    </ObjectEvent>
  </EventList>
</EPCISBody>
</EPCISHeader>
</extension>
</EPCISMasterData>
</EPCISHeader>
</EPCISBody>
</EventList>
</ObjectEvent>
</eventTime>
</eventTimeZoneOffset>
</epcList/>
</action>
</bizStep>

```

```

<disposition>urn:epcglobal:cbv:disp:in_progress</disposition>
<readPoint>
  <id>urn:epc:id:sgln:0614141.00000.0</id>
</readPoint>
<extension>
  <quantityList>
    <!-- In this example, the EPCIS quantityElement data structure contains the
lgtin for the lowest saleable unit (LSU) and the quantity value is given in terms of LSUs. For
this example scenario, each ordered case contains 12 LSUs. Hence, the quantity value will be
computed by multiplying the order case quantity with 12 LSUs. -->
    <quantityElement>
      <epcClass>urn:epc:class:lgtin:030000.0000001.L1</epcClass>
      <quantity>60</quantity>
    </quantityElement>
  </quantityList>
  <sourceList>
    <source
type="urn:epcglobal:cbv:sdt:owning_party">urn:epc:id:sgln:030000.000000.0</source>
  </sourceList>
  <destinationList>
    <destination
type="urn:epcglobal:cbv:sdt:owning_party">urn:epc:id:sgln:0614141.00000.0</destination>
  </destinationList>
</extension>
</ObjectEvent>
</EventList>
</EPCISBody>
</epcis:EPCISDocument>

```

### 12.1.1.3 Sample XML: Exchange2 - Seller → Buyer

Reference File: <https://resources.gs1us.org/Portals/0/xml/LotException-ExplicitOverageKeep-SellerExchange2.xml>

```

<?xml version="1.0" encoding="UTF-8"?>
<!-- Lot Exception Explicit Overage (Keep) - Exchange2: Seller -> Buyer -->
<!-- Seller investigates discrepancy and resolves issue by generating Shipping Event for the 1
extra case. -->
<epcis:EPCISDocument xmlns:cbvmda="urn:epcglobal:cbv:mda"
xmlns:sbdh="http://www.unece.org/cefact/namespaces/StandardBusinessDocumentHeader"
xmlns:gslushc="http://epcis.gs1us.org/hc/ns" xmlns:epcis="urn:epcglobal:epcis:xsd:1"
schemaVersion="1.2" xsi:schemaLocation="urn:epcglobal:epcis:xsd:1 EPCglobal-epcis-1_2.xsd"
xmlns:xsi="http://www.w3.org/2001/XMLSchema-instance" creationDate="2014-04-03T15:14:27.574-
04:00">
  <EPCISHeader>
    <sbdh:StandardBusinessDocumentHeader>
      <sbdh:HeaderVersion>1.0</sbdh:HeaderVersion>
      <sbdh:Sender>
        <sbdh:Identifier
Authority="SGLN">urn:epc:id:sgln:030000.000000.0</sbdh:Identifier>
      </sbdh:Sender>
      <sbdh:Receiver>
        <sbdh:Identifier
Authority="SGLN">urn:epc:id:sgln:0614141.00000.0</sbdh:Identifier>
      </sbdh:Receiver>
      <sbdh:DocumentIdentification>
        <sbdh:Standard>EPCglobal</sbdh:Standard>
        <sbdh:TypeVersion>1.0</sbdh:TypeVersion>
        <sbdh:InstanceIdentifier>1234567892</sbdh:InstanceIdentifier>
        <sbdh:Type>Events</sbdh:Type>

```

```

        <sbdh:CreationDateAndTime>2014-04-03T15:14:27.574-04:00</sbdh:CreationDateAndTime>
    </sbdh:DocumentIdentification>
</sbdh:StandardBusinessDocumentHeader>
<extension>
    <EPCISMasterData>
        <VocabularyList>
            <Vocabulary type="urn:epcglobal:epcis:vtype:EPCClass">
                <VocabularyElementList>
                    <VocabularyElement id="urn:epc:class:lgtn:030000.0000001.L1">
                        <attribute id="urn:epcglobal:cbv:mda#itemExpirationDate">2017-10-
31</attribute>

                        </VocabularyElement>
                    <VocabularyElement id="urn:epc:idpat:sgtin:030000.0000001.*">
                        <attribute
id="urn:epcglobal:cbv:mda#additionalTradeItemIdentification">0000000001</attribute>
                        <attribute
id="urn:epcglobal:cbv:mda#additionalTradeItemIdentificationTypeCode">FDA_NDC_11</attribute>
                        <attribute
id="urn:epcglobal:cbv:mda#regulatedProductName">Epcistra</attribute>
                        <attribute
id="urn:epcglobal:cbv:mda#manufacturerOfTradeItemPartyName">GS1 Pharma LLC</attribute>
                        <attribute id="urn:epcglobal:cbv:mda#dosageFormType">PILL</attribute>
                        <attribute
id="urn:epcglobal:cbv:mda#strengthDescription">100mg</attribute>
                        <attribute id="urn:epcglobal:cbv:mda#netContentDescription">500
pills</attribute>

                        </VocabularyElement>
                    </VocabularyElementList>
                </Vocabulary>
            <Vocabulary type="urn:epcglobal:epcis:vtype:Location">
                <VocabularyElementList>
                    <VocabularyElement id="urn:epc:id:sgln:030000.000000.0">
                        <attribute id="urn:epcglobal:cbv:mda#name">GS1 Pharma LLC</attribute>
                        <attribute id="urn:epcglobal:cbv:mda#streetAddressOne">1295 S George
Ave</attribute>
                        <attribute id="urn:epcglobal:cbv:mda#streetAddressTwo">Room
378</attribute>
                        <attribute id="urn:epcglobal:cbv:mda#city">Washington</attribute>
                        <attribute id="urn:epcglobal:cbv:mda#state">DC</attribute>
                        <attribute id="urn:epcglobal:cbv:mda#postalCode">12345-
6789</attribute>
                        <attribute id="urn:epcglobal:cbv:mda#countryCode">US</attribute>
                    </VocabularyElement>
                    <VocabularyElement id="urn:epc:id:sgln:0614141.00000.0">
                        <attribute id="urn:epcglobal:cbv:mda#name">GS1 Drug Distro
LLC</attribute>
                        <attribute id="urn:epcglobal:cbv:mda#streetAddressOne">230 Park Ave
S</attribute>
                        <attribute id="urn:epcglobal:cbv:mda#city">New York</attribute>
                        <attribute id="urn:epcglobal:cbv:mda#state">NY</attribute>
                        <attribute id="urn:epcglobal:cbv:mda#postalCode">10003-
1502</attribute>
                        <attribute id="urn:epcglobal:cbv:mda#countryCode">US</attribute>
                    </VocabularyElement>
                </VocabularyElementList>
            </Vocabulary>
        </VocabularyList>
    </EPCISMasterData>
</extension>
<gslushc:dscsaTransactionStatement>
    <gslushc:affirmTransactionStatement>true</gslushc:affirmTransactionStatement>

```



```

    <gslushc:legalNotice>Seller has complied with each applicable subsection of FDCA Sec.
581 (27) (A) - (G).</gslushc:legalNotice>
  </gslushc:dscsaTransactionStatement>
</EPCISHeader>
<EPCISBody>
  <EventList>
    <!-- Transaction Information (TI) -->
    <ObjectEvent>
      <eventTime>2014-04-01T10:11:12Z</eventTime>
      <eventTimeZoneOffset>-05:00</eventTimeZoneOffset>
      <epcList/>
      <action>OBSERVE</action>
      <bizStep>urn:epcglobal:cbv:bizstep:shipping</bizStep>
      <disposition>urn:epcglobal:cbv:disp:in_transit</disposition>
      <readPoint>
        <id>urn:epc:id:sgln:030000.000000.0</id>
      </readPoint>
      <extension>
        <quantityList>
          <!-- In this example, the EPCIS quantityElement data
structure contains the lgtin for the lowest saleable unit (LSU) and the quantity value is given
in terms of LSUs. For this example scenario, each ordered case contains 12 LSUs. Hence, the
quantity value will be computed by multiplying the order case quantity with 12 LSUs. -->
          <quantityElement>
            <epcClass>urn:epc:class:lgtin:030000.0000001.L1</epcClass>
            <quantity>12</quantity>
          </quantityElement>
        </quantityList>
      </sourceList>
      <sourceList>
        <source
type="urn:epcglobal:cbv:sdt:owning_party">urn:epc:id:sgln:030000.000000.0</source>
      </sourceList>
      <destinationList>
        <destination
type="urn:epcglobal:cbv:sdt:owning_party">urn:epc:id:sgln:0614141.00000.0</destination>
      </destinationList>
      </extension>
    </ObjectEvent>
  </EventList>
</EPCISBody>
</epcis:EPCISDocument>

```

### 12.1.1.4 Sample XML: Buyer Receives Product (2nd Receipt)

Reference File: <https://resources.gs1us.org/Portals/0/xml/LotException-ExplicitOverageKeep-BuyerReceives-2nd.xml>

```

<?xml version="1.0" encoding="UTF-8"?>
<!-- Lot Exception Explicit Overage (Keep) - Buyer Receives Product (2nd Receipt) -->
<!-- After receiving the incoming DSCSA supporting data for the 1 case, buyer takes the 1 case
out of quarantine and receives the 1 case into inventory -->
<epcis:EPCISDocument xmlns:cbvmda="urn:epcglobal:cbv:mda"
xmlns:sbdh="http://www.unece.org/cefact/namespaces/StandardBusinessDocumentHeader"
xmlns:gslushc="http://epcis.gs1us.org/hc/ns" xmlns:epcis="urn:epcglobal:epcis:xsd:1"
schemaVersion="1.2" xsi:schemaLocation="urn:epcglobal:epcis:xsd:1 EPCglobal-epcis-1_2.xsd"
xmlns:xsi="http://www.w3.org/2001/XMLSchema-instance" creationDate="2014-04-04T15:14:27.574-
04:00">
  <EPCISHeader>
    <sbdh:StandardBusinessDocumentHeader>
      <sbdh:HeaderVersion>1.0</sbdh:HeaderVersion>

```

```

    <sbdh:Sender>
      <sbdh:Identifier
Authority="SGLN">urn:epc:id:sgln:0614141.00000.0</sbdh:Identifier>
    </sbdh:Sender>
    <sbdh:Receiver>
      <sbdh:Identifier
Authority="SGLN">urn:epc:id:sgln:0614141.11111.0</sbdh:Identifier>
    </sbdh:Receiver>
    <sbdh:DocumentIdentification>
      <sbdh:Standard>EPCglobal</sbdh:Standard>
      <sbdh:TypeVersion>1.0</sbdh:TypeVersion>
      <sbdh:InstanceIdentifier>1234567893</sbdh:InstanceIdentifier>
      <sbdh:Type>Events</sbdh:Type>
      <sbdh:CreationDateAndTime>2014-04-04T15:14:27.574-04:00</sbdh:CreationDateAndTime>
    </sbdh:DocumentIdentification>
  </sbdh:StandardBusinessDocumentHeader>
  <extension>
    <EPCISMasterData>
      <VocabularyList>
        <Vocabulary type="urn:epcglobal:epcis:vtype:EPCClass">
          <VocabularyElementList>
            <VocabularyElement id="urn:epc:class:lgtn:030000.0000001.L1">
              <attribute id="urn:epcglobal:cbv:mda#itemExpirationDate">2017-10-
31</attribute>
            </VocabularyElement>
            <VocabularyElement id="urn:epc:idpat:sgtin:030000.0000001.*">
              <attribute
id="urn:epcglobal:cbv:mda#additionalTradeItemIdentification">00000000001</attribute>
              <attribute
id="urn:epcglobal:cbv:mda#additionalTradeItemIdentificationTypeCode">FDA_NDC_11</attribute>
              <attribute
id="urn:epcglobal:cbv:mda#regulatedProductName">Epcistra</attribute>
              <attribute
id="urn:epcglobal:cbv:mda#manufacturerOfTradeItemPartyName">GS1 Pharma LLC</attribute>
              <attribute id="urn:epcglobal:cbv:mda#dosageFormType">PILL</attribute>
              <attribute
id="urn:epcglobal:cbv:mda#strengthDescription">100mg</attribute>
              <attribute id="urn:epcglobal:cbv:mda#netContentDescription">500
pills</attribute>
            </VocabularyElement>
          </VocabularyElementList>
        </Vocabulary>
        <Vocabulary type="urn:epcglobal:epcis:vtype:Location">
          <VocabularyElementList>
            <VocabularyElement id="urn:epc:id:sgln:030000.000000.0">
              <attribute id="urn:epcglobal:cbv:mda#name">GS1 Pharma LLC</attribute>
              <attribute id="urn:epcglobal:cbv:mda#streetAddressOne">1295 S George
Ave</attribute>
              <attribute id="urn:epcglobal:cbv:mda#streetAddressTwo">Room
378</attribute>
              <attribute id="urn:epcglobal:cbv:mda#city">Washington</attribute>
              <attribute id="urn:epcglobal:cbv:mda#state">DC</attribute>
              <attribute id="urn:epcglobal:cbv:mda#postalCode">12345-
6789</attribute>
              <attribute id="urn:epcglobal:cbv:mda#countryCode">US</attribute>
            </VocabularyElement>
            <VocabularyElement id="urn:epc:id:sgln:0614141.00000.0">
              <attribute id="urn:epcglobal:cbv:mda#name">GS1 Drug Distro
LLC</attribute>
              <attribute id="urn:epcglobal:cbv:mda#streetAddressOne">230 Park Ave
S</attribute>

```

```

1502</attribute>
    <attribute id="urn:epcglobal:cbv:mda#city">New York</attribute>
    <attribute id="urn:epcglobal:cbv:mda#state">NY</attribute>
    <attribute id="urn:epcglobal:cbv:mda#postalCode">10003-
1502</attribute>
    <attribute id="urn:epcglobal:cbv:mda#countryCode">US</attribute>
  </VocabularyElement>
</VocabularyElementList>
</Vocabulary>
</VocabularyList>
</EPCISMasterData>
</extension>
</EPCISHeader>
<EPCISBody>
  <EventList>
    <ObjectEvent>
      <eventTime>2014-04-04T10:11:12Z</eventTime>
      <eventTimeZoneOffset>-05:00</eventTimeZoneOffset>
      <epcList/>
      <action>OBSERVE</action>
      <bizStep>urn:epcglobal:cbv:bizstep:receiving</bizStep>
      <disposition>urn:epcglobal:cbv:disp:in_progress</disposition>
      <readPoint>
        <id>urn:epc:id:sgln:0614141.00000.0</id>
      </readPoint>
      <extension>
        <quantityList>
          <!-- In this example, the EPCIS quantityElement data
structure contains the lgtin for the lowest saleable unit (LSU) and the quantity value is given
in terms of LSUs. For this example scenario, each ordered case contains 12 LSUs. Hence, the
quantity value will be computed by multiplying the order case quantity with 12 LSUs. -->
          <quantityElement>
            <epcClass>urn:epc:class:lgtin:030000.0000001.L1</epcClass>
            <quantity>12</quantity>
          </quantityElement>
        </quantityList>
      </sourceList>
      <sourceList>
        <source
type="urn:epcglobal:cbv:sdt:owning_party">urn:epc:id:sgln:030000.000000.0</source>
      </sourceList>
      <destinationList>
        <destination
type="urn:epcglobal:cbv:sdt:owning_party">urn:epc:id:sgln:0614141.00000.0</destination>
      </destinationList>
    </extension>
  </ObjectEvent>
</EventList>
</EPCISBody>
</epcis:EPCISDocument>

```

## 12.1.2 Return or Refuse the Product

- 
**Note:** In this scenario, the Buyer wants to return or refuse the extra product in the shipment. While the outcome of the two explicit overage scenarios varies, the return/refusal process variation is not modeled in the sample XML because this guideline focuses on DSCSA related exchanges only.

### 12.1.2.1 Sample XML: Exchange1 - Seller → Buyer

- 
**Note:** The message content of *Exchange1 of Seller -> Buyer* in this example is identical to the content of the *Exchange1 of Seller -> Buyer* in the [Explicit Overage \(Keep the Product\)](#).

Reference File: <https://resources.gs1us.org/Portals/0/xml/LotException-ExplicitOverageRefuseReturn-SellerExchange1.xml>

```
<?xml version="1.0" encoding="UTF-8"?>
<!-- Lot Exception: Explicit Overage (Refuse/Return) - Exchange1: Seller -> Buyer-->
<!-- Seller physically ships 6 cases by mistake. Seller's IT system reflects only 5 cases were shipped. -->
<!-- Note: This Seller -> Buyer transaction in this example is identical to the Seller -> Buyer content for Explicit Overage (Keep) - Exchange1 -->
<epcis:EPCISDocument xmlns:cbvmda="urn:epcglobal:cbv:mda"
xmlns:sbdh="http://www.unece.org/cefact/namespaces/StandardBusinessDocumentHeader"
xmlns:gslushc="http://epcis.gs1us.org/hc/ns" xmlns:epcis="urn:epcglobal:epcis:xsd:1"
schemaVersion="1.2" xsi:schemaLocation="urn:epcglobal:epcis:xsd:1 EPCglobal-epcis-1_2.xsd"
xmlns:xsi="http://www.w3.org/2001/XMLSchema-instance" creationDate="2014-04-01T15:14:27.574-04:00">
  <EPCISHeader>
    <sbdh:StandardBusinessDocumentHeader>
      <sbdh:HeaderVersion>1.0</sbdh:HeaderVersion>
      <sbdh:Sender>
        <sbdh:Identifier
Authority="SGLN">urn:epc:id:sgln:030000.000000.0</sbdh:Identifier>
        </sbdh:Sender>
        <sbdh:Receiver>
          <sbdh:Identifier
Authority="SGLN">urn:epc:id:sgln:0614141.000000.0</sbdh:Identifier>
          </sbdh:Receiver>
        <sbdh:DocumentIdentification>
          <sbdh:Standard>EPCglobal</sbdh:Standard>
          <sbdh:TypeVersion>1.0</sbdh:TypeVersion>
          <sbdh:InstanceIdentifier>1234567890</sbdh:InstanceIdentifier>
          <sbdh:Type>Events</sbdh:Type>
          <sbdh:CreationDateAndTime>2014-04-01T15:14:27.574-04:00</sbdh:CreationDateAndTime>
        </sbdh:DocumentIdentification>
      </sbdh:StandardBusinessDocumentHeader>
      <extension>
        <EPCISMasterData>
          <VocabularyList>
            <Vocabulary type="urn:epcglobal:epcis:vtype:EPCClass">
              <VocabularyElementList>
                <VocabularyElement id="urn:epc:class:lgtn:030000.0000001.L1">
                  <attribute id="urn:epcglobal:cbv:mda:itemExpirationDate">2017-10-
31</attribute>
                </VocabularyElement>
                <VocabularyElement id="urn:epc:idpat:sgtin:030000.0000001.*">
```

```

        <attribute
id="urn:epcglobal:cbv:mda#additionalTradeItemIdentification">0000000001</attribute>
        <attribute
id="urn:epcglobal:cbv:mda#additionalTradeItemIdentificationTypeCode">FDA_NDC_11</attribute>
        <attribute
id="urn:epcglobal:cbv:mda#regulatedProductName">Epcistra</attribute>
        <attribute
id="urn:epcglobal:cbv:mda#manufacturerOfTradeItemPartyName">GS1 Pharma LLC</attribute>
        <attribute id="urn:epcglobal:cbv:mda#dosageFormType">PILL</attribute>
        <attribute
id="urn:epcglobal:cbv:mda#strengthDescription">100mg</attribute>
        <attribute id="urn:epcglobal:cbv:mda#netContentDescription">500
pills</attribute>
    </VocabularyElement>
</VocabularyElementList>
</Vocabulary>
<Vocabulary type="urn:epcglobal:epcis:vtype:Location">
    <VocabularyElementList>
        <VocabularyElement id="urn:epc:id:sgln:030000.000000.0">
            <attribute id="urn:epcglobal:cbv:mda#name">GS1 Pharma LLC</attribute>
            <attribute id="urn:epcglobal:cbv:mda#streetAddressOne">1295 S George
Ave</attribute>
            <attribute id="urn:epcglobal:cbv:mda#streetAddressTwo">Room
378</attribute>
            <attribute id="urn:epcglobal:cbv:mda#city">Washington</attribute>
            <attribute id="urn:epcglobal:cbv:mda#state">DC</attribute>
            <attribute id="urn:epcglobal:cbv:mda#postalCode">12345-
6789</attribute>
            <attribute id="urn:epcglobal:cbv:mda#countryCode">US</attribute>
        </VocabularyElement>
        <VocabularyElement id="urn:epc:id:sgln:0614141.000000.0">
            <attribute id="urn:epcglobal:cbv:mda#name">GS1 Drug Distro
LLC</attribute>
            <attribute id="urn:epcglobal:cbv:mda#streetAddressOne">230 Park Ave
S</attribute>
            <attribute id="urn:epcglobal:cbv:mda#city">New York</attribute>
            <attribute id="urn:epcglobal:cbv:mda#state">NY</attribute>
            <attribute id="urn:epcglobal:cbv:mda#postalCode">10003-
1502</attribute>
            <attribute id="urn:epcglobal:cbv:mda#countryCode">US</attribute>
        </VocabularyElement>
    </VocabularyElementList>
</Vocabulary>
</VocabularyList>
</EPCISMasterData>
</extension>
<gslushc:dscsaTransactionStatement>
    <gslushc:affirmTransactionStatement>true</gslushc:affirmTransactionStatement>
    <gslushc:legalNotice>Seller has complied with each applicable subsection of FDCA Sec.
581 (27) (A) - (G).</gslushc:legalNotice>
</gslushc:dscsaTransactionStatement>
</EPCISHeader>
<EPCISBody>
    <EventList>
        <!-- Transaction Information (TI) -->
        <ObjectEvent>
            <eventTime>2014-04-01T10:11:12Z</eventTime>
            <eventTimeZoneOffset>-05:00</eventTimeZoneOffset>
            <epcList/>
            <action>OBSERVE</action>
            <bizStep>urn:epcglobal:cbv:bizstep:shipping</bizStep>

```

```

<disposition>urn:epcglobal:cbv:disp:in_transit</disposition>
<readPoint>
  <id>urn:epc:id:sgln:030000.000000.0</id>
</readPoint>
<extension>
  <quantityList>
    <!-- In this example, the EPCIS quantityElement data
structure contains the lgtin for the lowest saleable unit (LSU) and the quantity value is given
in terms of LSUs. For this example scenario, each ordered case contains 12 LSUs. Hence, the
quantity value will be computed by multiplying the order case quantity with 12 LSUs. -->
    <quantityElement>
      <epcClass>urn:epc:class:lgtin:030000.0000001.L1</epcClass>
      <quantity>60</quantity>
    </quantityElement>
  </quantityList>
  <sourceList>
    <source
type="urn:epcglobal:cbv:sdt:owning_party">urn:epc:id:sgln:030000.000000.0</source>
  </sourceList>
  <destinationList>
    <destination
type="urn:epcglobal:cbv:sdt:owning_party">urn:epc:id:sgln:0614141.00000.0</destination>
  </destinationList>
</extension>
</ObjectEvent>
</EventList>
</EPCISBody>
</epcis:EPCISDocument>

```

### 12.1.2.2 Sample XML: Buyer Receives Product



**Note:** The message content for when *Buyer Receives Product* in this example is identical to the content of the *Buyer Receives Product* in the [Explicit Overage \(Keep the Product\)](#) example.

Reference File: <https://resources.gs1us.org/Portals/0/xml/LotException-ExplicitOverageRefuseReturn-BuyerReceives.xml>

```

<?xml version="1.0" encoding="UTF-8"?>
<!-- Lot Exception: Explicit Overage (Refuse/Return) - Buyer Receives Product -->
<!-- Buyer receives 5 cases with supporting DSCSA data -->
<!-- Note: This Buyer Receives Product transaction in this example is identical to the content
for Explicit Overage (Keep) - Buyer Receives Product (First Receipt) -->
<epcis:EPCISDocument xmlns:cbvmda="urn:epcglobal:cbv:mda"
xmlns:sbdh="http://www.unece.org/cefact/namespaces/StandardBusinessDocumentHeader"
xmlns:gslushc="http://epcis.gs1us.org/hc/ns" xmlns:epcis="urn:epcglobal:epcis:xsd:1"
schemaVersion="1.2" xsi:schemaLocation="urn:epcglobal:epcis:xsd:1 EPCglobal-epcis-1_2.xsd"
xmlns:xsi="http://www.w3.org/2001/XMLSchema-instance" creationDate="2014-04-02T15:14:27.574-
04:00">
  <EPCISHeader>
    <sbdh:StandardBusinessDocumentHeader>
      <sbdh:HeaderVersion>1.0</sbdh:HeaderVersion>
      <sbdh:Sender>
        <sbdh:Identifier
Authority="SGLN">urn:epc:id:sgln:0614141.00000.0</sbdh:Identifier>
      </sbdh:Sender>
      <sbdh:Receiver>
        <sbdh:Identifier
Authority="SGLN">urn:epc:id:sgln:0614141.11111.0</sbdh:Identifier>
      </sbdh:Receiver>

```

```

<sbdh:DocumentIdentification>
  <sbdh:Standard>EPCglobal</sbdh:Standard>
  <sbdh:TypeVersion>1.0</sbdh:TypeVersion>
  <sbdh:InstanceIdentifier>1234567891</sbdh:InstanceIdentifier>
  <sbdh:Type>Events</sbdh:Type>
  <sbdh:CreationDateAndTime>2014-04-02T15:14:27.574-04:00</sbdh:CreationDateAndTime>
</sbdh:DocumentIdentification>
</sbdh:StandardBusinessDocumentHeader>
<extension>
  <EPCISMasterData>
    <VocabularyList>
      <Vocabulary type="urn:epcglobal:epcis:vtype:EPCClass">
        <VocabularyElementList>
          <VocabularyElement id="urn:epc:class:lgtin:030000.0000001.L1">
            <attribute id="urn:epcglobal:cbv:mda#itemExpirationDate">2017-10-
31</attribute>
          </VocabularyElement>
          <VocabularyElement id="urn:epc:idpat:sgtin:030000.0000001.*">
            <attribute
id="urn:epcglobal:cbv:mda#additionalTradeItemIdentification">0000000001</attribute>
            <attribute
id="urn:epcglobal:cbv:mda#additionalTradeItemIdentificationTypeCode">FDA_NDC_11</attribute>
            <attribute
id="urn:epcglobal:cbv:mda#regulatedProductName">Epcistra</attribute>
            <attribute
id="urn:epcglobal:cbv:mda#manufacturerOfTradeItemPartyName">GS1 Pharma LLC</attribute>
            <attribute id="urn:epcglobal:cbv:mda#dosageFormType">PILL</attribute>
            <attribute
id="urn:epcglobal:cbv:mda#strengthDescription">100mg</attribute>
            <attribute id="urn:epcglobal:cbv:mda#netContentDescription">500
pills</attribute>
          </VocabularyElement>
        </VocabularyElementList>
      </Vocabulary>
      <Vocabulary type="urn:epcglobal:epcis:vtype:Location">
        <VocabularyElementList>
          <VocabularyElement id="urn:epc:id:sgln:030000.000000.0">
            <attribute id="urn:epcglobal:cbv:mda#name">GS1 Pharma LLC</attribute>
            <attribute id="urn:epcglobal:cbv:mda#streetAddressOne">1295 S George
Ave</attribute>
            <attribute id="urn:epcglobal:cbv:mda#streetAddressTwo">Room
378</attribute>
            <attribute id="urn:epcglobal:cbv:mda#city">Washington</attribute>
            <attribute id="urn:epcglobal:cbv:mda#state">DC</attribute>
            <attribute id="urn:epcglobal:cbv:mda#postalCode">12345-
6789</attribute>
            <attribute id="urn:epcglobal:cbv:mda#countryCode">US</attribute>
          </VocabularyElement>
          <VocabularyElement id="urn:epc:id:sgln:0614141.00000.0">
            <attribute id="urn:epcglobal:cbv:mda#name">GS1 Drug Distro
LLC</attribute>
            <attribute id="urn:epcglobal:cbv:mda#streetAddressOne">230 Park Ave
S</attribute>
            <attribute id="urn:epcglobal:cbv:mda#city">New York</attribute>
            <attribute id="urn:epcglobal:cbv:mda#state">NY</attribute>
            <attribute id="urn:epcglobal:cbv:mda#postalCode">10003-
1502</attribute>
            <attribute id="urn:epcglobal:cbv:mda#countryCode">US</attribute>
          </VocabularyElement>
        </VocabularyElementList>
      </Vocabulary>
    </VocabularyList>
  </EPCISMasterData>
</extension>

```

```

        </VocabularyList>
    </EPCISMasterData>
</extension>
</EPCISHeader>
<EPCISBody>
    <EventList>
        <ObjectEvent>
            <eventTime>2014-04-02T10:11:12Z</eventTime>
            <eventTimeZoneOffset>-05:00</eventTimeZoneOffset>
            <epcList/>
            <action>OBSERVE</action>
            <bizStep>urn:epcglobal:cbv:bizstep:receiving</bizStep>
            <disposition>urn:epcglobal:cbv:disp:in_progress</disposition>
            <readPoint>
                <id>urn:epc:id:sgln:0614141.00000.0</id>
            </readPoint>
            <extension>
                <quantityList>
                    <!-- In this example, the EPCIS quantityElement data structure contains the
                    lgtin for the lowest saleable unit (LSU) and the quantity value is given in terms of LSUs. For
                    this example scenario, each ordered case contains 12 LSUs. Hence, the quantity value will be
                    computed by multiplying the order case quantity with 12 LSUs. -->
                    <quantityElement>
                        <epcClass>urn:epc:class:lgtin:030000.0000001.L1</epcClass>
                        <quantity>60</quantity>
                    </quantityElement>
                </quantityList>
                <sourceList>
                    <source
type="urn:epcglobal:cbv:sdt:owning_party">urn:epc:id:sgln:030000.000000.0</source>
                </sourceList>
                <destinationList>
                    <destination
type="urn:epcglobal:cbv:sdt:owning_party">urn:epc:id:sgln:0614141.00000.0</destination>
                </destinationList>
            </extension>
        </ObjectEvent>
    </EventList>
</EPCISBody>
</epcis:EPCISDocument>

```



## 12.2 Explicit Shortage

### 12.2.1 Buyer Wants the Item

#### 12.2.1.1 Sample XML: Exchange1 - Seller → Buyer

Reference File: <https://resources.gs1us.org/Portals/0/xml/LotException-ExplicitShortageBuyerWantsItem-SellerExchange1.xml>

```
<?xml version="1.0" encoding="UTF-8"?>
<!-- Lot Exception: Explicit Shortage (Buyer Wants Item) - Exchange1: Seller -> Buyer-->
<!-- Buyer orders 5 cases and seller physically ships 4 cases instead of 5 by mistake.
Seller's IT system reflects 5 cases were shipped. -->
<epcis:EPCISDocument xmlns:cbvmda="urn:epcglobal:cbv:mda"
xmlns:sbdh="http://www.unece.org/cefact/namespaces/StandardBusinessDocumentHeader"
xmlns:gslushc="http://epcis.gs1us.org/hc/ns" xmlns:epcis="urn:epcglobal:epcis:xsd:1"
schemaVersion="1.2" xsi:schemaLocation="urn:epcglobal:epcis:xsd:1 EPCglobal-epcis-1_2.xsd"
xmlns:xsi="http://www.w3.org/2001/XMLSchema-instance" creationDate="2014-04-01T15:14:27.574-
04:00">
  <EPCISHeader>
    <sbdh:StandardBusinessDocumentHeader>
      <sbdh:HeaderVersion>1.0</sbdh:HeaderVersion>
      <sbdh:Sender>
        <sbdh:Identifier
Authority="SGLN">urn:epc:id:sgln:030000.000000.0</sbdh:Identifier>
        </sbdh:Sender>
        <sbdh:Receiver>
          <sbdh:Identifier
Authority="SGLN">urn:epc:id:sgln:0614141.00000.0</sbdh:Identifier>
        </sbdh:Receiver>
        <sbdh:DocumentIdentification>
          <sbdh:Standard>EPCglobal</sbdh:Standard>
          <sbdh:TypeVersion>1.0</sbdh:TypeVersion>
          <sbdh:InstanceIdentifier>1234567880</sbdh:InstanceIdentifier>
          <sbdh:Type>Events</sbdh:Type>
          <sbdh:CreationDateAndTime>2014-04-01T15:14:27.574-04:00</sbdh:CreationDateAndTime>
        </sbdh:DocumentIdentification>
      </sbdh:StandardBusinessDocumentHeader>
      <extension>
        <EPCISMasterData>
          <VocabularyList>
            <Vocabulary type="urn:epcglobal:epcis:vtype:EPCClass">
              <VocabularyElementList>
                <VocabularyElement id="urn:epc:class:lgtn:030000.0000001.L1">
                  <attribute id="urn:epcglobal:cbv:mda#itemExpirationDate">2017-10-
31</attribute>
                </VocabularyElement>
                <VocabularyElement id="urn:epc:idpat:sgtin:030000.0000001.*">
                  <attribute
id="urn:epcglobal:cbv:mda#additionalTradeItemIdentification">00000000001</attribute>
                  <attribute
id="urn:epcglobal:cbv:mda#additionalTradeItemIdentificationTypeCode">FDA_NDC_11</attribute>
                  <attribute
id="urn:epcglobal:cbv:mda#regulatedProductName">Epcistra</attribute>
                  <attribute
id="urn:epcglobal:cbv:mda#manufacturerOfTradeItemPartyName">GS1 Pharma LLC</attribute>
                  <attribute id="urn:epcglobal:cbv:mda#dosageFormType">PILL</attribute>
                  <attribute
id="urn:epcglobal:cbv:mda#strengthDescription">100mg</attribute>
```

```

                    <attribute id="urn:epcglobal:cbv:mda#netContentDescription">500
pills</attribute>
                </VocabularyElement>
            </VocabularyElementList>
        </Vocabulary>
        <Vocabulary type="urn:epcglobal:epcis:vtype:Location">
            <VocabularyElementList>
                <VocabularyElement id="urn:epc:id:sgln:030000.000000.0">
                    <attribute id="urn:epcglobal:cbv:mda#name">GS1 Pharma LLC</attribute>
                    <attribute id="urn:epcglobal:cbv:mda#streetAddressOne">1295 S George
Ave</attribute>
                    <attribute id="urn:epcglobal:cbv:mda#streetAddressTwo">Room
378</attribute>
                    <attribute id="urn:epcglobal:cbv:mda#city">Washington</attribute>
                    <attribute id="urn:epcglobal:cbv:mda#state">DC</attribute>
                    <attribute id="urn:epcglobal:cbv:mda#postalCode">12345-
6789</attribute>
                    <attribute id="urn:epcglobal:cbv:mda#countryCode">US</attribute>
                </VocabularyElement>
            <VocabularyElement id="urn:epc:id:sgln:0614141.00000.0">
                <attribute id="urn:epcglobal:cbv:mda#name">GS1 Drug Distro
LLC</attribute>
                <attribute id="urn:epcglobal:cbv:mda#streetAddressOne">230 Park Ave
S</attribute>
                <attribute id="urn:epcglobal:cbv:mda#city">New York</attribute>
                <attribute id="urn:epcglobal:cbv:mda#state">NY</attribute>
                <attribute id="urn:epcglobal:cbv:mda#postalCode">10003-
1502</attribute>
                <attribute id="urn:epcglobal:cbv:mda#countryCode">US</attribute>
            </VocabularyElement>
        </VocabularyElementList>
    </Vocabulary>
</VocabularyList>
</EPCISMasterData>
</extension>
<gslushc:dscsaTransactionStatement>
    <gslushc:affirmTransactionStatement>true</gslushc:affirmTransactionStatement>
    <gslushc:legalNotice>Seller has complied with each applicable subsection of FDCA Sec.
581 (27) (A) - (G).</gslushc:legalNotice>
</gslushc:dscsaTransactionStatement>
</EPCISHeader>
<EPCISBody>
    <EventList>
        <!-- Transaction Information (TI) -->
        <ObjectEvent>
            <eventTime>2014-04-01T10:11:12Z</eventTime>
            <eventTimeZoneOffset>-05:00</eventTimeZoneOffset>
            <epcList/>
            <action>OBSERVE</action>
            <bizStep>urn:epcglobal:cbv:bizstep:shipping</bizStep>
            <disposition>urn:epcglobal:cbv:disp:in_transit</disposition>
            <readPoint>
                <id>urn:epc:id:sgln:030000.000000.0</id>
            </readPoint>
            <extension>
                <quantityList>
                    <!-- In this example, the EPCIS quantityElement data
structure contains the lgtin for the lowest saleable unit (LSU) and the quantity value is given
in terms of LSUs. For this example scenario, each ordered case contains 12 LSUs. Hence, the
quantity value will be computed by multiplying the order case quantity with 12 LSUs. -->
                <quantityElement>

```

```

        <epcClass>urn:epc:class:lgtin:030000.0000001.L1</epcClass>
        <quantity>60</quantity>
      </quantityElement>
    </quantityList>
    <sourceList>
      <source
type="urn:epcglobal:cbv:sdt:owning_party">urn:epc:id:sgln:030000.000000.0</source>
    </sourceList>
    <destinationList>
      <destination
type="urn:epcglobal:cbv:sdt:owning_party">urn:epc:id:sgln:0614141.00000.0</destination>
    </destinationList>
  </extension>
</ObjectEvent>
</EventList>
</EPCISBody>
</epcis:EPCISDocument>

```

### 12.2.1.2 Sample XML: Buyer Receives Product (1st Receipt)

Reference File: <https://resources.gs1us.org/Portals/0/xml/LotException-ExplicitShortageBuyerWantsItem-BuyerReceives-1st.xml>

```

<?xml version="1.0" encoding="UTF-8"?>
<!-- Lot Exception: Explicit Shortage (Buyer Wants Item) - Buyer Receives Product (First Receipt) -->
<!--Buyer receives 4 cases with supporting DSCSA data -->
<epcis:EPCISDocument xmlns:cbvmda="urn:epcglobal:cbv:mda"
xmlns:sbdh="http://www.unece.org/cefact/namespaces/StandardBusinessDocumentHeader"
xmlns:gslushc="http://epcis.gs1us.org/hc/ns" xmlns:epcis="urn:epcglobal:epcis:xsd:1"
schemaVersion="1.2" xsi:schemaLocation="urn:epcglobal:epcis:xsd:1 EPCglobal-epcis-1_2.xsd"
xmlns:xsi="http://www.w3.org/2001/XMLSchema-instance" creationDate="2014-04-02T15:14:27.574-04:00">
  <EPCISHeader>
    <sbdh:StandardBusinessDocumentHeader>
      <sbdh:HeaderVersion>1.0</sbdh:HeaderVersion>
      <sbdh:Sender>
        <sbdh:Identifier
Authority="SGLN">urn:epc:id:sgln:0614141.00000.0</sbdh:Identifier>
      </sbdh:Sender>
      <sbdh:Receiver>
        <sbdh:Identifier
Authority="SGLN">urn:epc:id:sgln:0614141.11111.0</sbdh:Identifier>
      </sbdh:Receiver>
      <sbdh:DocumentIdentification>
        <sbdh:Standard>EPCglobal</sbdh:Standard>
        <sbdh:TypeVersion>1.0</sbdh:TypeVersion>
        <sbdh:InstanceIdentifier>1234567881</sbdh:InstanceIdentifier>
        <sbdh:Type>Events</sbdh:Type>
        <sbdh:CreationDateAndTime>2014-04-02T15:14:27.574-04:00</sbdh:CreationDateAndTime>
      </sbdh:DocumentIdentification>
    </sbdh:StandardBusinessDocumentHeader>
    <extension>
      <EPCISMasterData>
        <VocabularyList>
          <Vocabulary type="urn:epcglobal:epcis:vtype:EPCClass">
            <VocabularyElementList>
              <VocabularyElement id="urn:epc:class:lgtin:030000.0000001.L1">
                <attribute id="urn:epcglobal:cbv:mda:itemExpirationDate">2017-10-
31</attribute>

```



```

    <extension>
      <quantityList>
        <!-- In this example, the EPCIS quantityElement data
        structure contains the lgtin for the lowest saleable unit (LSU) and the quantity value is given
        in terms of LSUs. For this example scenario, each ordered case contains 12 LSUs. Hence, the
        quantity value will be computed by multiplying the order case quantity with 12 LSUs. -->
        <quantityElement>
          <epcClass>urn:epc:class:lgtin:030000.0000001.L1</epcClass>
          <quantity>48</quantity>
        </quantityElement>
      </quantityList>
      <sourceList>
        <source
type="urn:epcglobal:cbv:sdt:owning_party">urn:epc:id:sgln:030000.000000.0</source>
      </sourceList>
      <destinationList>
        <destination
type="urn:epcglobal:cbv:sdt:owning_party">urn:epc:id:sgln:0614141.00000.0</destination>
      </destinationList>
    </extension>
  </ObjectEvent>
</EventList>
</EPCISBody>
</epcis:EPCISDocument>

```

### 12.2.1.3 Sample XML: Seller Corrects Shipment Data

Reference File: <https://resources.gs1us.org/Portals/0/xml/LotException-ExplicitShortageBuyerWantsItem-SellerCorrectsShipmentData.xml>

```

<?xml version="1.0" encoding="UTF-8"?>
<!-- Lot Exception: Explicit Shortage (Buyer Wants Item) - Seller corrects shipment data -->
<!-- Seller investigates discrepancy and resolves issue by generating voidShipping event for
the 1 case that was not shipped -->
<epcis:EPCISDocument xmlns:cbvmda="urn:epcglobal:cbv:mda"
xmlns:sbdh="http://www.unece.org/cefact/namespaces/StandardBusinessDocumentHeader"
xmlns:gslushc="http://epcis.gs1us.org/hc/ns" xmlns:epcis="urn:epcglobal:epcis:xsd:1"
schemaVersion="1.2" xsi:schemaLocation="urn:epcglobal:epcis:xsd:1 EPCglobal-epcis-1_2.xsd"
xmlns:xsi="http://www.w3.org/2001/XMLSchema-instance" creationDate="2014-04-03T15:14:27.574-
04:00">
  <EPCISHeader>
    <sbdh:StandardBusinessDocumentHeader>
      <sbdh:HeaderVersion>1.0</sbdh:HeaderVersion>
      <sbdh:Sender>
        <sbdh:Identifier
Authority="SGLN">urn:epc:id:sgln:030000.000000.0</sbdh:Identifier>
      </sbdh:Sender>
      <sbdh:Receiver>
        <sbdh:Identifier
Authority="SGLN">urn:epc:id:sgln:030000.000001.0</sbdh:Identifier>
      </sbdh:Receiver>
      <sbdh:DocumentIdentification>
        <sbdh:Standard>EPCglobal</sbdh:Standard>
        <sbdh:TypeVersion>1.0</sbdh:TypeVersion>
        <sbdh:InstanceIdentifier>1234567882</sbdh:InstanceIdentifier>
        <sbdh:Type>Events</sbdh:Type>
        <sbdh:CreationDateAndTime>2014-04-03T15:14:27.574-04:00</sbdh:CreationDateAndTime>
      </sbdh:DocumentIdentification>
    </sbdh:StandardBusinessDocumentHeader>
  </extension>

```

```

    <EPCISMasterData>
      <VocabularyList>
        <Vocabulary type="urn:epcglobal:epcis:vtype:EPCClass">
          <VocabularyElementList>
            <VocabularyElement id="urn:epc:class:lgtin:030000.0000001.L1">
              <attribute id="urn:epcglobal:cbv:mda#itemExpirationDate">2017-10-
31</attribute>
            </VocabularyElement>
            <VocabularyElement id="urn:epc:idpat:sgtin:030000.0000001.*">
              <attribute
id="urn:epcglobal:cbv:mda#additionalTradeItemIdentification">00000000001</attribute>
              <attribute
id="urn:epcglobal:cbv:mda#additionalTradeItemIdentificationTypeCode">FDA_NDC_11</attribute>
              <attribute
id="urn:epcglobal:cbv:mda#regulatedProductName">Epcistra</attribute>
              <attribute
id="urn:epcglobal:cbv:mda#manufacturerOfTradeItemPartyName">GS1 Pharma LLC</attribute>
              <attribute id="urn:epcglobal:cbv:mda#dosageFormType">PILL</attribute>
              <attribute
id="urn:epcglobal:cbv:mda#strengthDescription">100mg</attribute>
              <attribute id="urn:epcglobal:cbv:mda#netContentDescription">500
pills</attribute>
            </VocabularyElement>
          </VocabularyElementList>
        </Vocabulary>
        <Vocabulary type="urn:epcglobal:epcis:vtype:Location">
          <VocabularyElementList>
            <VocabularyElement id="urn:epc:id:sgln:030000.000000.0">
              <attribute id="urn:epcglobal:cbv:mda#name">GS1 Pharma LLC</attribute>
              <attribute id="urn:epcglobal:cbv:mda#streetAddressOne">1295 S George
Ave</attribute>
              <attribute id="urn:epcglobal:cbv:mda#streetAddressTwo">Room
378</attribute>
              <attribute id="urn:epcglobal:cbv:mda#city">Washington</attribute>
              <attribute id="urn:epcglobal:cbv:mda#state">DC</attribute>
              <attribute id="urn:epcglobal:cbv:mda#postalCode">12345-
6789</attribute>
              <attribute id="urn:epcglobal:cbv:mda#countryCode">US</attribute>
            </VocabularyElement>
            <VocabularyElement id="urn:epc:id:sgln:0614141.00000.0">
              <attribute id="urn:epcglobal:cbv:mda#name">GS1 Drug Distro
LLC</attribute>
              <attribute id="urn:epcglobal:cbv:mda#streetAddressOne">230 Park Ave
S</attribute>
              <attribute id="urn:epcglobal:cbv:mda#city">New York</attribute>
              <attribute id="urn:epcglobal:cbv:mda#state">NY</attribute>
              <attribute id="urn:epcglobal:cbv:mda#postalCode">10003-
1502</attribute>
              <attribute id="urn:epcglobal:cbv:mda#countryCode">US</attribute>
            </VocabularyElement>
          </VocabularyElementList>
        </Vocabulary>
      </VocabularyList>
    </EPCISMasterData>
  </extension>
</EPCISHeader>
<EPCISBody>
  <EventList>
    <ObjectEvent>
      <eventTime>2014-04-03T10:11:12Z</eventTime>
      <eventTimeZoneOffset>-05:00</eventTimeZoneOffset>
    </ObjectEvent>
  </EventList>
</EPCISBody>
</EPCISHeader>

```

```

<epcList/>
<action>OBSERVE</action>
<bizStep>urn:epcglobal:cbv:bizstep:void_shipping</bizStep>
<disposition>urn:epcglobal:cbv:disp:in_progress</disposition>
<readPoint>
  <id>urn:epc:id:sgln:030000.000000.0</id>
</readPoint>
<extension>
  <quantityList>
    <!-- In this example, the EPCIS quantityElement data
structure contains the lgtin for the lowest saleable unit (LSU) and the quantity value is given
in terms of LSUs. For this example scenario, each ordered case contains 12 LSUs
Hence, the quantity value will be computed by multiplying the order case quantity with 12
LSUs. -->
    <quantityElement>
      <epcClass>urn:epc:class:lgtin:030000.0000001.L1</epcClass>
      <quantity>12</quantity>
    </quantityElement>
  </quantityList>
</sourceList>
<sourceList>
  <source
type="urn:epcglobal:cbv:sdt:owning_party">urn:epc:id:sgln:030000.000000.0</source>
</sourceList>
<destinationList>
  <destination
type="urn:epcglobal:cbv:sdt:owning_party">urn:epc:id:sgln:0614141.00000.0</destination>
</destinationList>
</extension>
</ObjectEvent>
</EventList>
</EPCISBody>
</epcis:EPCISDocument>

```

#### 12.2.1.4 Sample XML: Exchange2 - Seller → Buyer

Reference File: <https://resources.gs1us.org/Portals/0/xml/LotException-ExplicitShortageBuyerWantsItem-SellerExchange2.xml>

```

<?xml version="1.0" encoding="UTF-8"?>
<!-- Lot Exception: Explicit Shortage (Buyer Wants Item) - Exchange2: Seller -> Buyer-->
<!-- Seller ships additional case against the original order along with a new Shipping event
for the missing case -->
<epcis:EPCISDocument xmlns:cbvmda="urn:epcglobal:cbv:mda"
xmlns:sbdh="http://www.unece.org/cefact/namespaces/StandardBusinessDocumentHeader"
xmlns:gslushc="http://epcis.gslus.org/hc/ns" xmlns:epcis="urn:epcglobal:epcis:xsd:1"
schemaVersion="1.2" xsi:schemaLocation="urn:epcglobal:epcis:xsd:1 EPCglobal-epcis-1_2.xsd"
xmlns:xsi="http://www.w3.org/2001/XMLSchema-instance" creationDate="2014-04-04T15:14:27.574-
04:00">
  <EPCISHeader>
    <sbdh:StandardBusinessDocumentHeader>
      <sbdh:HeaderVersion>1.0</sbdh:HeaderVersion>
      <sbdh:Sender>
        <sbdh:Identifier
Authority="SGLN">urn:epc:id:sgln:030000.000000.0</sbdh:Identifier>
      </sbdh:Sender>
      <sbdh:Receiver>
        <sbdh:Identifier
Authority="SGLN">urn:epc:id:sgln:0614141.00000.0</sbdh:Identifier>
      </sbdh:Receiver>
      <sbdh:DocumentIdentification>

```



```

    <sbdh:Standard>EPCglobal</sbdh:Standard>
    <sbdh:TypeVersion>1.0</sbdh:TypeVersion>
    <sbdh:InstanceIdentifier>1234567883</sbdh:InstanceIdentifier>
    <sbdh:Type>Events</sbdh:Type>
    <sbdh:CreationDateAndTime>2014-04-04T15:14:27.574-04:00</sbdh:CreationDateAndTime>
  </sbdh:DocumentIdentification>
</sbdh:StandardBusinessDocumentHeader>
<extension>
  <EPCISMasterData>
    <VocabularyList>
      <Vocabulary type="urn:epcglobal:epcis:vtype:EPCClass">
        <VocabularyElementList>
          <VocabularyElement id="urn:epc:class:lgtn:030000.0000001.L1">
            <attribute id="urn:epcglobal:cbv:mda#itemExpirationDate">2017-10-
31</attribute>
          </VocabularyElement>
          <VocabularyElement id="urn:epc:idpat:sgtin:030000.0000001.*">
            <attribute
id="urn:epcglobal:cbv:mda#additionalTradeItemIdentification">0000000001</attribute>
            <attribute
id="urn:epcglobal:cbv:mda#additionalTradeItemIdentificationTypeCode">FDA_NDC_11</attribute>
            <attribute
id="urn:epcglobal:cbv:mda#regulatedProductName">Epcistra</attribute>
            <attribute
id="urn:epcglobal:cbv:mda#manufacturerOfTradeItemPartyName">GS1 Pharma LLC</attribute>
            <attribute id="urn:epcglobal:cbv:mda#dosageFormType">PILL</attribute>
            <attribute
id="urn:epcglobal:cbv:mda#strengthDescription">100mg</attribute>
            <attribute id="urn:epcglobal:cbv:mda#netContentDescription">500
pills</attribute>
          </VocabularyElement>
        </VocabularyElementList>
      </Vocabulary>
      <Vocabulary type="urn:epcglobal:epcis:vtype:Location">
        <VocabularyElementList>
          <VocabularyElement id="urn:epc:id:sgln:030000.000000.0">
            <attribute id="urn:epcglobal:cbv:mda#name">GS1 Pharma LLC</attribute>
            <attribute id="urn:epcglobal:cbv:mda#streetAddressOne">1295 S George
Ave</attribute>
            <attribute id="urn:epcglobal:cbv:mda#streetAddressTwo">Room
378</attribute>
            <attribute id="urn:epcglobal:cbv:mda#city">Washington</attribute>
            <attribute id="urn:epcglobal:cbv:mda#state">DC</attribute>
            <attribute id="urn:epcglobal:cbv:mda#postalCode">12345-
6789</attribute>
            <attribute id="urn:epcglobal:cbv:mda#countryCode">US</attribute>
          </VocabularyElement>
          <VocabularyElement id="urn:epc:id:sgln:0614141.00000.0">
            <attribute id="urn:epcglobal:cbv:mda#name">GS1 Drug Distro
LLC</attribute>
            <attribute id="urn:epcglobal:cbv:mda#streetAddressOne">230 Park Ave
S</attribute>
            <attribute id="urn:epcglobal:cbv:mda#city">New York</attribute>
            <attribute id="urn:epcglobal:cbv:mda#state">NY</attribute>
            <attribute id="urn:epcglobal:cbv:mda#postalCode">10003-
1502</attribute>
            <attribute id="urn:epcglobal:cbv:mda#countryCode">US</attribute>
          </VocabularyElement>
        </VocabularyElementList>
      </Vocabulary>
    </VocabularyList>
  </EPCISMasterData>
</extension>

```



```

        </EPCISMasterData>
    </extension>
    <gslushc:dscsaTransactionStatement>
        <gslushc:affirmTransactionStatement>true</gslushc:affirmTransactionStatement>
        <gslushc:legalNotice>Seller has complied with each applicable subsection of FDCA Sec.
581 (27) (A) - (G).</gslushc:legalNotice>
    </gslushc:dscsaTransactionStatement>
</EPCISHeader>
<EPCISBody>
    <EventList>
        <!-- Transaction Information (TI) -->
        <ObjectEvent>
            <eventTime>2014-04-04T10:11:12Z</eventTime>
            <eventTimeZoneOffset>-05:00</eventTimeZoneOffset>
            <epcList/>
            <action>OBSERVE</action>
            <bizStep>urn:epcglobal:cbv:bizstep:shipping</bizStep>
            <disposition>urn:epcglobal:cbv:disp:in_transit</disposition>
            <readPoint>
                <id>urn:epc:id:sgln:030000.000000.0</id>
            </readPoint>
            <extension>
                <quantityList>
                    <!-- In this example, the EPCIS quantityElement data structure contains the
lgtin for the lowest saleable unit (LSU) and the quantity value is given in terms of LSUs. For
this example scenario, each ordered case contains 12 LSUs. Hence, the quantity value will be
computed by multiplying the order case quantity with 12 LSUs. -->
                    <quantityElement>
                        <epcClass>urn:epc:class:lgtin:030000.0000001.L1</epcClass>
                        <quantity>12</quantity>
                    </quantityElement>
                </quantityList>
                <sourceList>
                    <source
type="urn:epcglobal:cbv:sdt:owning_party">urn:epc:id:sgln:030000.000000.0</source>
                </sourceList>
                <destinationList>
                    <destination
type="urn:epcglobal:cbv:sdt:owning_party">urn:epc:id:sgln:0614141.00000.0</destination>
                </destinationList>
            </extension>
        </ObjectEvent>
    </EventList>
</EPCISBody>
</epcis:EPCISDocument>

```

### 12.2.1.5 Sample XML: Buyer Receives Product (2nd Receipt)

Reference File: <https://resources.gs1us.org/Portals/0/xml/LotException-ExplicitShortageBuyerWantsItem-BuyerReceives-2nd.xml>

```

<?xml version="1.0" encoding="UTF-8"?>
<!-- Lot Exception Explicit Shortage (Buyer Wants Item) - Buyer Receives Product (2nd Receipt) -->
<!-- After receiving physical shipment of 1 case and its DSCSA supporting data, Buyer receives
the 1 case into inventory -->
<epcis:EPCISDocument xmlns:cbvmda="urn:epcglobal:cbv:mda"
xmlns:sbdh="http://www.unece.org/cefact/namespaces/StandardBusinessDocumentHeader"
xmlns:gslushc="http://epcis.gs1us.org/hc/ns" xmlns:epcis="urn:epcglobal:epcis:xsd:1"
schemaVersion="1.2" xsi:schemaLocation="urn:epcglobal:epcis:xsd:1 EPCglobal-epcis-1_2.xsd"

```

```

xmlns:xsi="http://www.w3.org/2001/XMLSchema-instance" creationDate="2014-04-05T15:14:27.574-
04:00">
  <EPCISHeader>
    <sbdh:StandardBusinessDocumentHeader>
      <sbdh:HeaderVersion>1.0</sbdh:HeaderVersion>
      <sbdh:Sender>
        <sbdh:Identifier
Authority="SGLN">urn:epc:id:sgln:0614141.00000.0</sbdh:Identifier>
        </sbdh:Sender>
        <sbdh:Receiver>
          <sbdh:Identifier
Authority="SGLN">urn:epc:id:sgln:0614141.11111.0</sbdh:Identifier>
          </sbdh:Receiver>
        <sbdh:DocumentIdentification>
          <sbdh:Standard>EPCglobal</sbdh:Standard>
          <sbdh:TypeVersion>1.0</sbdh:TypeVersion>
          <sbdh:InstanceIdentifier>1234567884</sbdh:InstanceIdentifier>
          <sbdh:Type>Events</sbdh:Type>
          <sbdh:CreationDateAndTime>2014-04-05T15:14:27.574-04:00</sbdh:CreationDateAndTime>
        </sbdh:DocumentIdentification>
      </sbdh:StandardBusinessDocumentHeader>
      <extension>
        <EPCISMasterData>
          <VocabularyList>
            <Vocabulary type="urn:epcglobal:epcis:vtype:EPCClass">
              <VocabularyElementList>
                <VocabularyElement id="urn:epc:class:lgtin:030000.0000001.L1">
                  <attribute id="urn:epcglobal:cbv:mda#itemExpirationDate">2017-10-
31</attribute>
                </VocabularyElement>
                <VocabularyElement id="urn:epc:idpat:sgtin:030000.0000001.*">
                  <attribute
id="urn:epcglobal:cbv:mda#additionalTradeItemIdentification">00000000001</attribute>
                  <attribute
id="urn:epcglobal:cbv:mda#additionalTradeItemIdentificationTypeCode">FDA_NDC_11</attribute>
                  <attribute
id="urn:epcglobal:cbv:mda#regulatedProductName">Epcistra</attribute>
                  <attribute
id="urn:epcglobal:cbv:mda#manufacturerOfTradeItemPartyName">GS1 Pharma LLC</attribute>
                  <attribute id="urn:epcglobal:cbv:mda#dosageFormType">PILL</attribute>
                  <attribute
id="urn:epcglobal:cbv:mda#strengthDescription">100mg</attribute>
                  <attribute id="urn:epcglobal:cbv:mda#netContentDescription">500
pills</attribute>
                </VocabularyElement>
              </VocabularyElementList>
            </Vocabulary>
            <Vocabulary type="urn:epcglobal:epcis:vtype:Location">
              <VocabularyElementList>
                <VocabularyElement id="urn:epc:id:sgln:030000.000000.0">
                  <attribute id="urn:epcglobal:cbv:mda#name">GS1 Pharma LLC</attribute>
                  <attribute id="urn:epcglobal:cbv:mda#streetAddressOne">1295 S George
Ave</attribute>
                  <attribute id="urn:epcglobal:cbv:mda#streetAddressTwo">Room
378</attribute>
                  <attribute id="urn:epcglobal:cbv:mda#city">Washington</attribute>
                  <attribute id="urn:epcglobal:cbv:mda#state">DC</attribute>
                  <attribute id="urn:epcglobal:cbv:mda#postalCode">12345-
6789</attribute>
                  <attribute id="urn:epcglobal:cbv:mda#countryCode">US</attribute>
                </VocabularyElement>
              </VocabularyElementList>
            </Vocabulary>
          </VocabularyList>
        </EPCISMasterData>
      </extension>
    </EPCISHeader>
  </sbdh:StandardBusinessDocumentHeader>
</sbdh:StandardBusinessDocumentHeader>

```

```

        <VocabularyElement id="urn:epc:id:sgln:0614141.00000.0">
            <attribute id="urn:epcglobal:cbv:mda#name">GS1 Drug Distro
LLC</attribute>
            <attribute id="urn:epcglobal:cbv:mda#streetAddressOne">230 Park Ave
S</attribute>
            <attribute id="urn:epcglobal:cbv:mda#city">New York</attribute>
            <attribute id="urn:epcglobal:cbv:mda#state">NY</attribute>
            <attribute id="urn:epcglobal:cbv:mda#postalCode">10003-
1502</attribute>
            <attribute id="urn:epcglobal:cbv:mda#countryCode">US</attribute>
        </VocabularyElement>
    </VocabularyElementList>
</Vocabulary>
</VocabularyList>
</EPCISMasterData>
</extension>
</EPCISHeader>
<EPCISBody>
    <EventList>
        <ObjectEvent>
            <eventTime>2014-04-05T10:11:12Z</eventTime>
            <eventTimeZoneOffset>-05:00</eventTimeZoneOffset>
            <epcList/>
            <action>OBSERVE</action>
            <bizStep>urn:epcglobal:cbv:bizstep:receiving</bizStep>
            <disposition>urn:epcglobal:cbv:disp:in_progress</disposition>
            <readPoint>
                <id>urn:epc:id:sgln:0614141.00000.0</id>
            </readPoint>
            <extension>
                <quantityList>
                    <!-- In this example, the EPCIS quantityElement data structure contains the
lgtin for the lowest saleable unit (LSU) and the quantity value is given in terms of LSUs. For
this example scenario, each ordered case contains 12 LSUs. Hence, the quantity value will be
computed by multiplying the order case quantity with 12 LSUs. -->
                    <quantityElement>
                        <epcClass>urn:epc:class:lgtin:030000.0000001.L1</epcClass>
                        <quantity>12</quantity>
                    </quantityElement>
                </quantityList>
                <sourceList>
                    <source
type="urn:epcglobal:cbv:sdt:owning_party">urn:epc:id:sgln:030000.000000.0</source>
                </sourceList>
                <destinationList>
                    <destination
type="urn:epcglobal:cbv:sdt:owning_party">urn:epc:id:sgln:0614141.00000.0</destination>
                </destinationList>
            </extension>
        </ObjectEvent>
    </EventList>
</EPCISBody>
</epcis:EPCISDocument>

```

## 12.2.2 Buyer Cancels Item

### 12.2.2.1 Sample XML: Exchange1 - Seller → Buyer



**Note:** The message content of *Exchange1 of Seller -> Buyer* in example is identical to the content of the *Exchange1 of Seller -> Buyer* in the [Explicit Shortage \(Buyer Wants the Item\)](#) example.

Reference File: <https://resources.gs1us.org/Portals/0/xml/LotException-ExplicitShortageBuyerCancelsItem-SellerExchange1.xml>

```
<?xml version="1.0" encoding="UTF-8"?>
<!-- Lot Exception: Explicit Shortage (Buyer Cancels Item) - Exchange1: Seller -> Buyer-->
<!-- Buyer orders 5 cases and seller physically ships 4 cases instead of 5 by mistake.
Seller's IT system reflects 5 cases were shipped. -->
<!-- Note: This Seller -> Buyer transaction in this example is identical to the Seller ->
Buyer content for Explicit Shortage (Buyer Wants Item) - Exchange1-->
<epcis:EPCISDocument xmlns:cbvmda="urn:epcglobal:cbv:mda"
xmlns:sbdh="http://www.unece.org/cefact/namespaces/StandardBusinessDocumentHeader"
xmlns:gslushc="http://epcis.gs1us.org/hc/ns" xmlns:epcis="urn:epcglobal:epcis:xsd:1"
schemaVersion="1.2" xsi:schemaLocation="urn:epcglobal:epcis:xsd:1 EPCglobal-epcis-1_2.xsd"
xmlns:xsi="http://www.w3.org/2001/XMLSchema-instance" creationDate="2014-04-01T15:14:27.574-
04:00">
  <EPCISHeader>
    <sbdh:StandardBusinessDocumentHeader>
      <sbdh:HeaderVersion>1.0</sbdh:HeaderVersion>
      <sbdh:Sender>
        <sbdh:Identifier
Authority="SGLN">urn:epc:id:sgln:030000.000000.0</sbdh:Identifier>
        </sbdh:Sender>
        <sbdh:Receiver>
          <sbdh:Identifier
Authority="SGLN">urn:epc:id:sgln:0614141.00000.0</sbdh:Identifier>
          </sbdh:Receiver>
        <sbdh:DocumentIdentification>
          <sbdh:Standard>EPCglobal</sbdh:Standard>
          <sbdh:TypeVersion>1.0</sbdh:TypeVersion>
          <sbdh:InstanceIdentifier>1234567880</sbdh:InstanceIdentifier>
          <sbdh:Type>Events</sbdh:Type>
          <sbdh:CreationDateAndTime>2014-04-01T15:14:27.574-04:00</sbdh:CreationDateAndTime>
        </sbdh:DocumentIdentification>
      </sbdh:StandardBusinessDocumentHeader>
      <extension>
        <EPCISMasterData>
          <VocabularyList>
            <Vocabulary type="urn:epcglobal:epcis:vtype:EPCClass">
              <VocabularyElementList>
                <VocabularyElement id="urn:epc:class:lgtin:030000.0000001.L1">
                  <attribute id="urn:epcglobal:cbv:mda#itemExpirationDate">2017-10-
31</attribute>
                </VocabularyElement>
                <VocabularyElement id="urn:epc:idpat:sgtin:030000.0000001.*">
                  <attribute
id="urn:epcglobal:cbv:mda#additionalTradeItemIdentification">00000000001</attribute>
                  <attribute
id="urn:epcglobal:cbv:mda#additionalTradeItemIdentificationTypeCode">FDA_NDC_11</attribute>
                  <attribute
id="urn:epcglobal:cbv:mda#regulatedProductName">Epcistra</attribute>
                </VocabularyElement>
              </VocabularyElementList>
            </Vocabulary>
          </VocabularyList>
        </EPCISMasterData>
      </extension>
    </EPCISHeader>
  </epcis:EPCISDocument>

```

```

        <attribute
id="urn:epcglobal:cbv:mda#manufacturerOfTradeItemPartyName">GS1 Pharma LLC</attribute>
        <attribute id="urn:epcglobal:cbv:mda#dosageFormType">PILL</attribute>
        <attribute
id="urn:epcglobal:cbv:mda#strengthDescription">100mg</attribute>
        <attribute id="urn:epcglobal:cbv:mda#netContentDescription">500
pills</attribute>
    </VocabularyElement>
</VocabularyElementList>
</Vocabulary>
<Vocabulary type="urn:epcglobal:epcis:vtype:Location">
    <VocabularyElementList>
        <VocabularyElement id="urn:epc:id:sgln:030000.000000.0">
            <attribute id="urn:epcglobal:cbv:mda#name">GS1 Pharma LLC</attribute>
            <attribute id="urn:epcglobal:cbv:mda#streetAddressOne">1295 S George
Ave</attribute>
            <attribute id="urn:epcglobal:cbv:mda#streetAddressTwo">Room
378</attribute>
            <attribute id="urn:epcglobal:cbv:mda#city">Washington</attribute>
            <attribute id="urn:epcglobal:cbv:mda#state">DC</attribute>
            <attribute id="urn:epcglobal:cbv:mda#postalCode">12345-
6789</attribute>
            <attribute id="urn:epcglobal:cbv:mda#countryCode">US</attribute>
        </VocabularyElement>
        <VocabularyElement id="urn:epc:id:sgln:0614141.00000.0">
            <attribute id="urn:epcglobal:cbv:mda#name">GS1 Drug Distro
LLC</attribute>
            <attribute id="urn:epcglobal:cbv:mda#streetAddressOne">230 Park Ave
S</attribute>
            <attribute id="urn:epcglobal:cbv:mda#city">New York</attribute>
            <attribute id="urn:epcglobal:cbv:mda#state">NY</attribute>
            <attribute id="urn:epcglobal:cbv:mda#postalCode">10003-
1502</attribute>
            <attribute id="urn:epcglobal:cbv:mda#countryCode">US</attribute>
        </VocabularyElement>
    </VocabularyElementList>
</Vocabulary>
</VocabularyList>
</EPCISMasterData>
</extension>
<gslushc:dscsaTransactionStatement>
    <gslushc:affirmTransactionStatement>true</gslushc:affirmTransactionStatement>
    <gslushc:legalNotice>Seller has complied with each applicable subsection of FDCA Sec.
581 (27) (A) – (G).</gslushc:legalNotice>
</gslushc:dscsaTransactionStatement>
</EPCISHeader>
<EPCISBody>
    <EventList>
        <!-- Transaction Information (TI) -->
        <ObjectEvent>
            <eventTime>2014-04-01T10:11:12Z</eventTime>
            <eventTimeZoneOffset>-05:00</eventTimeZoneOffset>
            <epcList/>
            <action>OBSERVE</action>
            <bizStep>urn:epcglobal:cbv:bizstep:shipping</bizStep>
            <disposition>urn:epcglobal:cbv:disp:in_transit</disposition>
            <readPoint>
                <id>urn:epc:id:sgln:030000.000000.0</id>
            </readPoint>
            <extension>
                <quantityList>

```

```

        <!-- In this example, the EPCIS quantityElement data structure contains the
        lgtin for the lowest saleable unit (LSU) and the quantity value is given in terms of LSUs. For
        this example scenario, each ordered case contains 12 LSUs. Hence, the quantity value will be
        computed by multiplying the order case quantity with 12 LSUs. -->
        <quantityElement>
            <epcClass>urn:epc:class:lgtin:030000.0000001.L1</epcClass>
            <quantity>60</quantity>
        </quantityElement>
    </quantityList>
    <sourceList>
        <source
type="urn:epcglobal:cbv:sdt:owning_party">urn:epc:id:sgln:030000.000000.0</source>
        </sourceList>
    <destinationList>
        <destination
type="urn:epcglobal:cbv:sdt:owning_party">urn:epc:id:sgln:0614141.00000.0</destination>
        </destinationList>
    </extension>
</ObjectEvent>
</EventList>
</EPCISBody>
</epcis:EPCISDocument>

```

### 12.2.2.2 Sample XML: Buyer Receives Product



**Note:** The message content of *Buyer Receives Product* in this example is identical to the content of the *Buyer Receives Product* in the [Explicit Shortage \(Buyer Wants the Item\)](#) example

Reference File: <https://resources.gs1us.org/Portals/0/xml/LotException-ExplicitShortageBuyerCancelsItem-BuyerReceives.xml>

```

<?xml version="1.0" encoding="UTF-8"?>
<!-- Lot Exception: Explicit Shortage (Buyer Cancels Item) - Buyer Receives Product -->
<!-- Buyer receives 4 cases with supporting DSCSA data -->
<!-- Note: This Receiving transaction in this example is identical to the content for Explicit
Shortage (Buyer Wants Item) - Buyer Receives Product (First Receipt) -->
<epcis:EPCISDocument xmlns:cbvmda="urn:epcglobal:cbv:mda"
xmlns:sbdh="http://www.unece.org/cefact/namespaces/StandardBusinessDocumentHeader"
xmlns:gslushc="http://epcis.gs1us.org/hc/ns" xmlns:epcis="urn:epcglobal:epcis:xsd:1"
schemaVersion="1.2" xsi:schemaLocation="urn:epcglobal:epcis:xsd:1 EPCglobal-epcis-1_2.xsd"
xmlns:xsi="http://www.w3.org/2001/XMLSchema-instance" creationDate="2014-04-02T15:14:27.574-
04:00">
    <EPCISHeader>
        <sbdh:StandardBusinessDocumentHeader>
            <sbdh:HeaderVersion>1.0</sbdh:HeaderVersion>
            <sbdh:Sender>
                <sbdh:Identifier
Authority="SGLN">urn:epc:id:sgln:0614141.00000.0</sbdh:Identifier>
            </sbdh:Sender>
            <sbdh:Receiver>
                <sbdh:Identifier
Authority="SGLN">urn:epc:id:sgln:0614141.11111.0</sbdh:Identifier>
            </sbdh:Receiver>
            <sbdh:DocumentIdentification>
                <sbdh:Standard>EPCglobal</sbdh:Standard>
                <sbdh:TypeVersion>1.0</sbdh:TypeVersion>
                <sbdh:InstanceIdentifier>1234567881</sbdh:InstanceIdentifier>
                <sbdh:Type>Events</sbdh:Type>
                <sbdh:CreationDateAndTime>2014-04-02T15:14:27.574-04:00</sbdh:CreationDateAndTime>
            </sbdh:DocumentIdentification>
        </sbdh:StandardBusinessDocumentHeader>
    </EPCISHeader>

```

```

        </sbdh:DocumentIdentification>
    </sbdh:StandardBusinessDocumentHeader>
    <extension>
        <EPCISMasterData>
            <VocabularyList>
                <Vocabulary type="urn:epcglobal:epcis:vtype:EPCClass">
                    <VocabularyElementList>
                        <VocabularyElement id="urn:epc:class:lgtin:030000.0000001.L1">
                            <attribute id="urn:epcglobal:cbv:mda#itemExpirationDate">2017-10-
31</attribute>
                                </VocabularyElement>
                                <VocabularyElement id="urn:epc:idpat:sgtin:030000.0000001.*">
                                    <attribute
id="urn:epcglobal:cbv:mda#additionalTradeItemIdentification">00000000001</attribute>
                                    <attribute
id="urn:epcglobal:cbv:mda#additionalTradeItemIdentificationTypeCode">FDA_NDC_11</attribute>
                                    <attribute
id="urn:epcglobal:cbv:mda#regulatedProductName">Epcistra</attribute>
                                    <attribute
id="urn:epcglobal:cbv:mda#manufacturerOfTradeItemPartyName">GS1 Pharma LLC</attribute>
                                    <attribute id="urn:epcglobal:cbv:mda#dosageFormType">PILL</attribute>
                                    <attribute
id="urn:epcglobal:cbv:mda#strengthDescription">100mg</attribute>
                                    <attribute id="urn:epcglobal:cbv:mda#netContentDescription">500
pills</attribute>
                                </VocabularyElement>
                            </VocabularyElementList>
                        </Vocabulary>
                        <Vocabulary type="urn:epcglobal:epcis:vtype:Location">
                            <VocabularyElementList>
                                <VocabularyElement id="urn:epc:id:sgln:030000.000000.0">
                                    <attribute id="urn:epcglobal:cbv:mda#name">GS1 Pharma LLC</attribute>
                                    <attribute id="urn:epcglobal:cbv:mda#streetAddressOne">1295 S George
Ave</attribute>
                                    <attribute id="urn:epcglobal:cbv:mda#streetAddressTwo">Room
378</attribute>
                                    <attribute id="urn:epcglobal:cbv:mda#city">Washington</attribute>
                                    <attribute id="urn:epcglobal:cbv:mda#state">DC</attribute>
                                    <attribute id="urn:epcglobal:cbv:mda#postalCode">12345-
6789</attribute>
                                    <attribute id="urn:epcglobal:cbv:mda#countryCode">US</attribute>
                                </VocabularyElement>
                                <VocabularyElement id="urn:epc:id:sgln:0614141.00000.0">
                                    <attribute id="urn:epcglobal:cbv:mda#name">GS1 Drug Distro
LLC</attribute>
                                    <attribute id="urn:epcglobal:cbv:mda#streetAddressOne">230 Park Ave
S</attribute>
                                    <attribute id="urn:epcglobal:cbv:mda#city">New York</attribute>
                                    <attribute id="urn:epcglobal:cbv:mda#state">NY</attribute>
                                    <attribute id="urn:epcglobal:cbv:mda#postalCode">10003-
1502</attribute>
                                    <attribute id="urn:epcglobal:cbv:mda#countryCode">US</attribute>
                                </VocabularyElement>
                            </VocabularyElementList>
                        </Vocabulary>
                    </VocabularyList>
                </EPCISMasterData>
            </extension>
        </EPCISHeader>
    <EPCISBody>
        <EventList>

```

```

<ObjectEvent>
  <eventTime>2014-04-02T10:11:12Z</eventTime>
  <eventTimeZoneOffset>-05:00</eventTimeZoneOffset>
  <epcList/>
  <action>OBSERVE</action>
  <bizStep>urn:epcglobal:cbv:bizstep:receiving</bizStep>
  <disposition>urn:epcglobal:cbv:disp:in_progress</disposition>
  <readPoint>
    <id>urn:epc:id:sgln:0614141.00000.0</id>
  </readPoint>
  <extension>
    <quantityList>
      <!-- In this example, the EPCIS quantityElement data structure contains the
lgtn for the lowest saleable unit (LSU) and the quantity value is given in terms of LSUs. For
this example scenario, each ordered case contains 12 LSUs. Hence, the quantity value will be
computed by multiplying the order case quantity with 12 LSUs. -->
      <quantityElement>
        <epcClass>urn:epc:class:lgtn:030000.0000001.L1</epcClass>
        <quantity>48</quantity>
      </quantityElement>
    </quantityList>
    <sourceList>
      <source
type="urn:epcglobal:cbv:sdt:owning_party">urn:epc:id:sgln:030000.000000.0</source>
    </sourceList>
    <destinationList>
      <destination
type="urn:epcglobal:cbv:sdt:owning_party">urn:epc:id:sgln:0614141.00000.0</destination>
    </destinationList>
  </extension>
</ObjectEvent>
</EventList>
</EPCISBody>
</epcis:EPCISDocument>

```



### 12.2.2.3 Sample XML: Seller Corrects Shipment Data



**Note:** The message content of this example is identical to the content of the *Seller Corrects Shipment Data* in the [Explicit Shortage \(Buyer Wants the Item\)](#) example.

Reference File: <https://resources.gs1us.org/Portals/0/xml/LotException-ExplicitShortageBuyerCancelsItem-SellerCorrectsShipmentData.xml>

```
<?xml version="1.0" encoding="UTF-8"?>
<!-- Lot Exception: Explicit Shortage (Buyer Cancels Item) - Seller corrects shipment data -->
<!-- Seller investigates discrepancy and resolves issue by generating voidShipping event for
the 1 case that was not shipped -->
<!-- Note: This voidshipping transaction in this example is identical to the content for
Explicit Shortage (Buyer Wants Item) - Seller corrects shipment data -->
<epcis:EPCISDocument xmlns:cbvmda="urn:epcglobal:cbv:mda"
xmlns:sbdh="http://www.unece.org/cefact/namespace/StandardBusinessDocumentHeader"
xmlns:gslushc="http://epcis.gs1us.org/hc/ns" xmlns:epcis="urn:epcglobal:epcis:xsd:1"
schemaVersion="1.2" xsi:schemaLocation="urn:epcglobal:epcis:xsd:1 EPCglobal-epcis-1_2.xsd"
xmlns:xsi="http://www.w3.org/2001/XMLSchema-instance" creationDate="2014-04-03T15:14:27.574-
04:00">
  <EPCISHeader>
    <sbdh:StandardBusinessDocumentHeader>
      <sbdh:HeaderVersion>1.0</sbdh:HeaderVersion>
      <sbdh:Sender>
        <sbdh:Identifier
Authority="SGLN">urn:epc:id:sgln:030000.000000.0</sbdh:Identifier>
        </sbdh:Sender>
      <sbdh:Receiver>
        <sbdh:Identifier
Authority="SGLN">urn:epc:id:sgln:030000.000001.0</sbdh:Identifier>
        </sbdh:Receiver>
      <sbdh:DocumentIdentification>
        <sbdh:Standard>EPCglobal</sbdh:Standard>
        <sbdh:TypeVersion>1.0</sbdh:TypeVersion>
        <sbdh:InstanceIdentifier>1234567882</sbdh:InstanceIdentifier>
        <sbdh:Type>Events</sbdh:Type>
        <sbdh:CreationDateAndTime>2014-04-03T15:14:27.574-04:00</sbdh:CreationDateAndTime>
      </sbdh:DocumentIdentification>
    </sbdh:StandardBusinessDocumentHeader>
    <extension>
      <EPCISMasterData>
        <VocabularyList>
          <Vocabulary type="urn:epcglobal:epcis:vtype:EPCClass">
            <VocabularyElementList>
              <VocabularyElement id="urn:epc:class:lgtn:030000.0000001.L1">
                <attribute id="urn:epcglobal:cbv:mda#itemExpirationDate">2017-10-
31</attribute>
              </VocabularyElement>
              <VocabularyElement id="urn:epc:idpat:sgtin:030000.0000001.*">
                <attribute
id="urn:epcglobal:cbv:mda#additionalTradeItemIdentification">00000000001</attribute>
                <attribute
id="urn:epcglobal:cbv:mda#additionalTradeItemIdentificationTypeCode">FDA_NDC_11</attribute>
                <attribute
id="urn:epcglobal:cbv:mda#regulatedProductName">Epcistra</attribute>
                <attribute
id="urn:epcglobal:cbv:mda#manufacturerOfTradeItemPartyName">GS1 Pharma LLC</attribute>
                <attribute id="urn:epcglobal:cbv:mda#dosageFormType">PILL</attribute>
              </VocabularyElementList>
            </Vocabulary>
          </VocabularyList>
        </EPCISMasterData>
      </extension>
    </EPCISHeader>
  </EPCISDocument>

```

```

        <attribute
id="urn:epcglobal:cbv:mda#strengthDescription">100mg</attribute>
        <attribute id="urn:epcglobal:cbv:mda#netContentDescription">500
pills</attribute>
        </VocabularyElement>
    </VocabularyElementList>
</Vocabulary>
<Vocabulary type="urn:epcglobal:epcis:vtype:Location">
    <VocabularyElementList>
        <VocabularyElement id="urn:epc:id:sgln:030000.000000.0">
            <attribute id="urn:epcglobal:cbv:mda#name">GS1 Pharma LLC</attribute>
            <attribute id="urn:epcglobal:cbv:mda#streetAddressOne">1295 S George
Ave</attribute>
            <attribute id="urn:epcglobal:cbv:mda#streetAddressTwo">Room
378</attribute>
            <attribute id="urn:epcglobal:cbv:mda#city">Washington</attribute>
            <attribute id="urn:epcglobal:cbv:mda#state">DC</attribute>
            <attribute id="urn:epcglobal:cbv:mda#postalCode">12345-
6789</attribute>
            <attribute id="urn:epcglobal:cbv:mda#countryCode">US</attribute>
        </VocabularyElement>
    </VocabularyElementList>
    <VocabularyElement id="urn:epc:id:sgln:0614141.00000.0">
        <attribute id="urn:epcglobal:cbv:mda#name">GS1 Drug Distro
LLC</attribute>
        <attribute id="urn:epcglobal:cbv:mda#streetAddressOne">230 Park Ave
S</attribute>
        <attribute id="urn:epcglobal:cbv:mda#city">New York</attribute>
        <attribute id="urn:epcglobal:cbv:mda#state">NY</attribute>
        <attribute id="urn:epcglobal:cbv:mda#postalCode">10003-
1502</attribute>
            <attribute id="urn:epcglobal:cbv:mda#countryCode">US</attribute>
        </VocabularyElement>
    </VocabularyElementList>
</Vocabulary>
</VocabularyList>
</EPCISMasterData>
</extension>
</EPCISHeader>
<EPCISBody>
    <EventList>
        <ObjectEvent>
            <eventTime>2014-04-03T10:11:12Z</eventTime>
            <eventTimeZoneOffset>-05:00</eventTimeZoneOffset>
            <epcList/>
            <action>OBSERVE</action>
            <bizStep>urn:epcglobal:cbv:bizstep:void_shipping</bizStep>
            <disposition>urn:epcglobal:cbv:disp:in_progress</disposition>
            <readPoint>
                <id>urn:epc:id:sgln:030000.000000.0</id>
            </readPoint>
            <extension>
                <quantityList>
                    <!-- In this example, the EPCIS quantityElement data structure contains the
lgtin for the lowest saleable unit (LSU) and the quantity value is given in terms of LSUs. For
this example scenario, each ordered case contains 12 LSUs. Hence, the quantity value will be
computed by multiplying the order case quantity with 12 LSUs. -->
                    <quantityElement>
                        <epcClass>urn:epc:class:lgtin:030000.0000001.L1</epcClass>
                        <quantity>12</quantity>
                    </quantityElement>
                </quantityList>
            </extension>
        </ObjectEvent>
    </EventList>
</EPCISBody>
</EPCIS>

```

```
        <sourceList>
          <source
type="urn:epcglobal:cbv:sdt:owning_party">urn:epc:id:sgln:030000.000000.0</source>
        </sourceList>
        <destinationList>
          <destination
type="urn:epcglobal:cbv:sdt:owning_party">urn:epc:id:sgln:0614141.00000.0</destination>
        </destinationList>
      </extension>
    </ObjectEvent>
  </EventList>
</EPCISBody>
</epcis:EPCISDocument>
```

## 12.3 Lot Number Discrepancy: Homogeneous or Mixed Shipment

### 12.3.1 Keep the Item

#### 12.3.1.1 Sample XML: Exchange1 - Seller → Buyer

Reference File: <https://resources.gs1us.org/Portals/0/xml/LotException-LotNumberDiscrepancyKeep-SellerExchange1.xml>

```
<?xml version="1.0" encoding="UTF-8"?>
<!-- Lot Exception: LotNumberDiscrepancy (Keep) - Exchange1: Seller -> Buyer-->
<!-- Buyer orders five cases and five cases arrive; however, the lot number on the cases do not
match the lot number on the EPCIS Shipping Event.
Seller physically shipped 3 cases of Lot #5 and 2 cases of Lot#6 . Contrastingly, the
Seller's IT system reflects all 5 cases of lot #5 were shipped. -->
<epcis:EPCISDocument xmlns:cbvmda="urn:epcglobal:cbv:mda"
xmlns:sbdh="http://www.unece.org/cefact/namespaces/StandardBusinessDocumentHeader"
xmlns:gslushc="http://epcis.gs1us.org/hc/ns" xmlns:epcis="urn:epcglobal:epcis:xsd:1"
schemaVersion="1.2" xsi:schemaLocation="urn:epcglobal:epcis:xsd:1 EPCglobal-epcis-1_2.xsd"
xmlns:xsi="http://www.w3.org/2001/XMLSchema-instance" creationDate="2014-04-01T15:14:27.574-
04:00">
  <EPCISHeader>
    <sbdh:StandardBusinessDocumentHeader>
      <sbdh:HeaderVersion>1.0</sbdh:HeaderVersion>
      <sbdh:Sender>
        <sbdh:Identifier
Authority="SGLN">urn:epc:id:sgln:030000.000000.0</sbdh:Identifier>
        </sbdh:Sender>
      <sbdh:Receiver>
        <sbdh:Identifier
Authority="SGLN">urn:epc:id:sgln:0614141.000000.0</sbdh:Identifier>
        </sbdh:Receiver>
      <sbdh:DocumentIdentification>
        <sbdh:Standard>EPCglobal</sbdh:Standard>
        <sbdh:TypeVersion>1.0</sbdh:TypeVersion>
        <sbdh:InstanceIdentifier>1234567885</sbdh:InstanceIdentifier>
        <sbdh:Type>Events</sbdh:Type>
        <sbdh:CreationDateAndTime>2014-04-01T15:14:27.574-04:00</sbdh:CreationDateAndTime>
      </sbdh:DocumentIdentification>
    </sbdh:StandardBusinessDocumentHeader>
    <extension>
      <EPCISMasterData>
        <VocabularyList>
          <Vocabulary type="urn:epcglobal:epcis:vtype:EPCClass">
            <VocabularyElementList>
              <VocabularyElement id="urn:epc:class:lgtin:030000.0000001.L5">
                <attribute id="urn:epcglobal:cbv:mda#itemExpirationDate">2017-10-
31</attribute>
              </VocabularyElement>
              <VocabularyElement id="urn:epc:idpat:sgtin:030000.0000001.*">
                <attribute
id="urn:epcglobal:cbv:mda#additionalTradeItemIdentification">0000000001</attribute>
                <attribute
id="urn:epcglobal:cbv:mda#additionalTradeItemIdentificationTypeCode">FDA_NDC_11</attribute>
                <attribute
id="urn:epcglobal:cbv:mda#regulatedProductName">Epcistra</attribute>
                <attribute
id="urn:epcglobal:cbv:mda#manufacturerOfTradeItemPartyName">GS1 Pharma LLC</attribute>
                <attribute id="urn:epcglobal:cbv:mda#dosageFormType">PILL</attribute>
              </VocabularyElementList>
            </Vocabulary>
          </VocabularyList>
        </EPCISMasterData>
      </extension>
    </EPCISHeader>
  </epcis:EPCISDocument>

```

```

        <attribute
id="urn:epcglobal:cbv:mda#strengthDescription">100mg</attribute>
        <attribute id="urn:epcglobal:cbv:mda#netContentDescription">500
pills</attribute>
        </VocabularyElement>
    </VocabularyElementList>
</Vocabulary>
<Vocabulary type="urn:epcglobal:epcis:vtype:Location">
    <VocabularyElementList>
        <VocabularyElement id="urn:epc:id:sgln:030000.000000.0">
            <attribute id="urn:epcglobal:cbv:mda#name">GS1 Pharma LLC</attribute>
            <attribute id="urn:epcglobal:cbv:mda#streetAddressOne">1295 S George
Ave</attribute>
            <attribute id="urn:epcglobal:cbv:mda#streetAddressTwo">Room
378</attribute>
            <attribute id="urn:epcglobal:cbv:mda#city">Washington</attribute>
            <attribute id="urn:epcglobal:cbv:mda#state">DC</attribute>
            <attribute id="urn:epcglobal:cbv:mda#postalCode">12345-
6789</attribute>
            <attribute id="urn:epcglobal:cbv:mda#countryCode">US</attribute>
        </VocabularyElement>
    <VocabularyElement id="urn:epc:id:sgln:0614141.000000.0">
        <attribute id="urn:epcglobal:cbv:mda#name">GS1 Drug Distro
LLC</attribute>
        <attribute id="urn:epcglobal:cbv:mda#streetAddressOne">230 Park Ave
S</attribute>
        <attribute id="urn:epcglobal:cbv:mda#city">New York</attribute>
        <attribute id="urn:epcglobal:cbv:mda#state">NY</attribute>
        <attribute id="urn:epcglobal:cbv:mda#postalCode">10003-
1502</attribute>
            <attribute id="urn:epcglobal:cbv:mda#countryCode">US</attribute>
        </VocabularyElement>
    </VocabularyElementList>
</Vocabulary>
</VocabularyList>
</EPCISMasterData>
</extension>
<gslushc:dscsaTransactionStatement>
    <gslushc:affirmTransactionStatement>true</gslushc:affirmTransactionStatement>
    <gslushc:legalNotice>Seller has complied with each applicable subsection of FDCA Sec.
581 (27) (A) - (G).</gslushc:legalNotice>
</gslushc:dscsaTransactionStatement>
</EPCISHeader>
<EPCISBody>
    <EventList>
        <!-- Transaction Information (TI) -->
        <ObjectEvent>
            <eventTime>2014-04-01T10:11:12Z</eventTime>
            <eventTimeZoneOffset>-05:00</eventTimeZoneOffset>
            <epcList/>
            <action>OBSERVE</action>
            <bizStep>urn:epcglobal:cbv:bizstep:shipping</bizStep>
            <disposition>urn:epcglobal:cbv:disp:in_transit</disposition>
            <readPoint>
                <id>urn:epc:id:sgln:030000.000000.0</id>
            </readPoint>
            <extension>
                <quantityList>
                    <!-- In this example, the EPCIS quantityElement data structure contains the
lgtin for the lowest saleable unit (LSU) and the quantity value is given in terms of LSUs. For

```

this example scenario, each ordered case contains 12 LSUs. Hence, the quantity value will be computed by multiplying the order case quantity with 12 LSUs. -->

```

    <quantityElement>
      <epcClass>urn:epc:class:lgtin:030000.0000001.L5</epcClass>
      <quantity>60</quantity>
    </quantityElement>
  </quantityList>
  <sourceList>
    <source
type="urn:epcglobal:cbv:sdt:owning_party">urn:epc:id:sgln:030000.000000.0</source>
  </sourceList>
  <destinationList>
    <destination
type="urn:epcglobal:cbv:sdt:owning_party">urn:epc:id:sgln:0614141.00000.0</destination>
  </destinationList>
</extension>
</ObjectEvent>
</EventList>
</EPCISBody>
</epcis:EPCISDocument>

```

### 12.3.1.2 Sample XML: Buyer Receives Product (1st Receipt)

Reference File: <https://resources.gs1us.org/Portals/0/xml/LotException-LotNumberDiscrepancyKeep-BuyerReceives-1st.xml>

```

<?xml version="1.0" encoding="UTF-8"?>
<!-- Lot Exception: LotNumberDiscrepancy (Keep) - Buyer Receives Product (First Receipt) -->
<!--Buyer receives 3 of the 5 cases with supporting DSCSA data listing lot#5 to match the 3
physical cases that arrived. -->
<epcis:EPCISDocument xmlns:cbvmda="urn:epcglobal:cbv:mda"
xmlns:sbdh="http://www.unece.org/cefact/namespaces/StandardBusinessDocumentHeader"
xmlns:gslushc="http://epcis.gs1us.org/hc/ns" xmlns:epcis="urn:epcglobal:epcis:xsd:1"
schemaVersion="1.2" xsi:schemaLocation="urn:epcglobal:epcis:xsd:1 EPCglobal-epcis-1_2.xsd"
xmlns:xsi="http://www.w3.org/2001/XMLSchema-instance" creationDate="2014-04-02T15:14:27.574-
04:00">
  <EPCISHeader>
    <sbdh:StandardBusinessDocumentHeader>
      <sbdh:HeaderVersion>1.0</sbdh:HeaderVersion>
      <sbdh:Sender>
        <sbdh:Identifier
Authority="SGLN">urn:epc:id:sgln:0614141.00000.0</sbdh:Identifier>
      </sbdh:Sender>
      <sbdh:Receiver>
        <sbdh:Identifier
Authority="SGLN">urn:epc:id:sgln:0614141.11111.0</sbdh:Identifier>
      </sbdh:Receiver>
      <sbdh:DocumentIdentification>
        <sbdh:Standard>EPCglobal</sbdh:Standard>
        <sbdh:TypeVersion>1.0</sbdh:TypeVersion>
        <sbdh:InstanceIdentifier>1234567886</sbdh:InstanceIdentifier>
        <sbdh:Type>Events</sbdh:Type>
        <sbdh:CreationDateAndTime>2014-04-02T15:14:27.574-04:00</sbdh:CreationDateAndTime>
      </sbdh:DocumentIdentification>
    </sbdh:StandardBusinessDocumentHeader>
    <extension>
      <EPCISMasterData>
        <VocabularyList>
          <Vocabulary type="urn:epcglobal:epcis:vtype:EPCClass">
            <VocabularyElementList>

```



```

<readPoint>
  <id>urn:epc:id:sgln:0614141.00000.0</id>
</readPoint>
<extension>
  <quantityList>
    <!-- In this example, the EPCIS quantityElement data structure contains the
lgtin for the lowest saleable unit (LSU) and the quantity value is given in terms of LSUs. For
this example scenario, each ordered case contains 12 LSUs. Hence, the quantity value will be
computed by multiplying the order case quantity with 12 LSUs. -->
    <quantityElement>
      <epcClass>urn:epc:class:lgtin:030000.0000001.L5</epcClass>
      <quantity>36</quantity>
    </quantityElement>
  </quantityList>
  <sourceList>
    <source
type="urn:epcglobal:cbv:sdt:owning_party">urn:epc:id:sgln:030000.000000.0</source>
  </sourceList>
  <destinationList>
    <destination
type="urn:epcglobal:cbv:sdt:owning_party">urn:epc:id:sgln:0614141.00000.0</destination>
  </destinationList>
</extension>
</ObjectEvent>
</EventList>
</EPCISBody>
</epcis:EPCISDocument>

```

### 12.3.1.3 Sample XML: Seller Corrects Shipment Data

Reference File: <https://resources.gs1us.org/Portals/0/xml/LotException-LotNumberDiscrepancyKeep-SellerCorrectsShipmentData.xml>

```

<?xml version="1.0" encoding="UTF-8"?>
<!-- Lot Exception: LotNumberDiscrepancy (Keep) - Seller corrects shipment data -->
<!-- Seller investigates discrepancy and resolves issue by generating voidShipping event for
the 2 cases of lot#5 -->
<epcis:EPCISDocument xmlns:cbvmda="urn:epcglobal:cbv:mda"
xmlns:sbdh="http://www.unece.org/cefact/namespaces/StandardBusinessDocumentHeader"
xmlns:gslushc="http://epcis.gs1us.org/hc/ns" xmlns:epcis="urn:epcglobal:epcis:xsd:1"
schemaVersion="1.2" xsi:schemaLocation="urn:epcglobal:epcis:xsd:1 EPCglobal-epcis-1_2.xsd"
xmlns:xsi="http://www.w3.org/2001/XMLSchema-instance" creationDate="2014-04-03T15:14:27.574-
04:00">
  <EPCISHeader>
    <sbdh:StandardBusinessDocumentHeader>
      <sbdh:HeaderVersion>1.0</sbdh:HeaderVersion>
      <sbdh:Sender>
        <sbdh:Identifier
Authority="SGLN">urn:epc:id:sgln:030000.000000.0</sbdh:Identifier>
      </sbdh:Sender>
      <sbdh:Receiver>
        <sbdh:Identifier
Authority="SGLN">urn:epc:id:sgln:030000.000001.0</sbdh:Identifier>
      </sbdh:Receiver>
      <sbdh:DocumentIdentification>
        <sbdh:Standard>EPCglobal</sbdh:Standard>
        <sbdh:TypeVersion>1.0</sbdh:TypeVersion>
        <sbdh:InstanceIdentifier>1234567887</sbdh:InstanceIdentifier>
        <sbdh:Type>Events</sbdh:Type>
        <sbdh:CreationDateAndTime>2014-04-03T15:14:27.574-04:00</sbdh:CreationDateAndTime>
      </sbdh:DocumentIdentification>
    </sbdh:StandardBusinessDocumentHeader>
  </EPCISHeader>
</epcis:EPCISDocument>

```



```

        </sbdh:DocumentIdentification>
    </sbdh:StandardBusinessDocumentHeader>
    <extension>
        <EPCISMasterData>
            <VocabularyList>
                <Vocabulary type="urn:epcglobal:epcis:vtype:EPCClass">
                    <VocabularyElementList>
                        <VocabularyElement id="urn:epc:class:lgtin:030000.0000001.L5">
                            <attribute id="urn:epcglobal:cbv:mda#itemExpirationDate">2017-10-
31</attribute>
                                </VocabularyElement>
                                <VocabularyElement id="urn:epc:idpat:sgtin:030000.0000001.*">
                                    <attribute
id="urn:epcglobal:cbv:mda#additionalTradeItemIdentification">00000000001</attribute>
                                    <attribute
id="urn:epcglobal:cbv:mda#additionalTradeItemIdentificationTypeCode">FDA_NDC_11</attribute>
                                    <attribute
id="urn:epcglobal:cbv:mda#regulatedProductName">Epcistra</attribute>
                                    <attribute
id="urn:epcglobal:cbv:mda#manufacturerOfTradeItemPartyName">GS1 Pharma LLC</attribute>
                                    <attribute id="urn:epcglobal:cbv:mda#dosageFormType">PILL</attribute>
                                    <attribute
id="urn:epcglobal:cbv:mda#strengthDescription">100mg</attribute>
                                    <attribute id="urn:epcglobal:cbv:mda#netContentDescription">500
pills</attribute>
                                </VocabularyElement>
                            </VocabularyElementList>
                        </Vocabulary>
                        <Vocabulary type="urn:epcglobal:epcis:vtype:Location">
                            <VocabularyElementList>
                                <VocabularyElement id="urn:epc:id:sgln:030000.000000.0">
                                    <attribute id="urn:epcglobal:cbv:mda#name">GS1 Pharma LLC</attribute>
                                    <attribute id="urn:epcglobal:cbv:mda#streetAddressOne">1295 S George
Ave</attribute>
                                    <attribute id="urn:epcglobal:cbv:mda#streetAddressTwo">Room
378</attribute>
                                    <attribute id="urn:epcglobal:cbv:mda#city">Washington</attribute>
                                    <attribute id="urn:epcglobal:cbv:mda#state">DC</attribute>
                                    <attribute id="urn:epcglobal:cbv:mda#postalCode">12345-
6789</attribute>
                                    <attribute id="urn:epcglobal:cbv:mda#countryCode">US</attribute>
                                </VocabularyElement>
                                <VocabularyElement id="urn:epc:id:sgln:0614141.00000.0">
                                    <attribute id="urn:epcglobal:cbv:mda#name">GS1 Drug Distro
LLC</attribute>
                                    <attribute id="urn:epcglobal:cbv:mda#streetAddressOne">230 Park Ave
S</attribute>
                                    <attribute id="urn:epcglobal:cbv:mda#city">New York</attribute>
                                    <attribute id="urn:epcglobal:cbv:mda#state">NY</attribute>
                                    <attribute id="urn:epcglobal:cbv:mda#postalCode">10003-
1502</attribute>
                                    <attribute id="urn:epcglobal:cbv:mda#countryCode">US</attribute>
                                </VocabularyElement>
                            </VocabularyElementList>
                        </Vocabulary>
                    </VocabularyList>
                </EPCISMasterData>
            </extension>
        </EPCISHeader>
    <EPCISBody>
        <EventList>

```

```

<ObjectEvent>
  <eventTime>2014-04-03T10:11:12Z</eventTime>
  <eventTimeZoneOffset>-05:00</eventTimeZoneOffset>
  <epcList/>
  <action>OBSERVE</action>
  <bizStep>urn:epcglobal:cbv:bizstep:void_shipping</bizStep>
  <disposition>urn:epcglobal:cbv:disp:in_progress</disposition>
  <readPoint>
    <id>urn:epc:id:sgln:030000.000000.0</id>
  </readPoint>
  <extension>
    <quantityList>
      <!-- In this example, the EPCIS quantityElement data structure contains the
lgtin for the lowest saleable unit (LSU) and the quantity value is given in terms of LSUs. For
this example scenario, each ordered case contains 12 LSUs. Hence, the quantity value will be
computed by multiplying the order case quantity with 12 LSUs. -->
      <quantityElement>
        <epcClass>urn:epc:class:lgtin:030000.0000001.L5</epcClass>
        <quantity>24</quantity>
      </quantityElement>
    </quantityList>
    <sourceList>
      <source
type="urn:epcglobal:cbv:sdt:owning_party">urn:epc:id:sgln:030000.000000.0</source>
    </sourceList>
    <destinationList>
      <destination
type="urn:epcglobal:cbv:sdt:owning_party">urn:epc:id:sgln:0614141.00000.0</destination>
    </destinationList>
  </extension>
</ObjectEvent>
</EventList>
</EPCISBody>
</epcis:EPCISDocument>

```

### 12.3.1.4 Sample XML: Exchange2 - Seller → Buyer

Reference File: <https://resources.gs1us.org/Portals/0/xml/LotException-LotNumberDiscrepancyKeep-SellerExchange2.xml>

```

<?xml version="1.0" encoding="UTF-8"?>
<!-- Lot Exception LotNumberDiscrepancy (Keep) - Exchange2: Seller -> Buyer -->
<!-- Seller investigates discrepancy and determines that there's a lot mismatch for the 2 cases
shipped.
Seller resolves issue by generating Shipping Event for the 2 cases for lot#6 -->
<epcis:EPCISDocument xmlns:cbvmda="urn:epcglobal:cbv:mda"
xmlns:sbdh="http://www.unece.org/cefact/namespaces/StandardBusinessDocumentHeader"
xmlns:gslushc="http://epcis.gs1us.org/hc/ns" xmlns:epcis="urn:epcglobal:epcis:xsd:1"
schemaVersion="1.2" xsi:schemaLocation="urn:epcglobal:epcis:xsd:1 EPCglobal-epcis-1_2.xsd"
xmlns:xsi="http://www.w3.org/2001/XMLSchema-instance" creationDate="2014-04-04T15:14:27.574-
04:00">
  <EPCISHeader>
    <sbdh:StandardBusinessDocumentHeader>
      <sbdh:HeaderVersion>1.0</sbdh:HeaderVersion>
      <sbdh:Sender>
        <sbdh:Identifier
Authority="SGLN">urn:epc:id:sgln:030000.000000.0</sbdh:Identifier>
      </sbdh:Sender>
      <sbdh:Receiver>

```

```

        <sbdh:Identifier
Authority="SGLN">urn:epc:id:sgln:0614141.00000.0</sbdh:Identifier>
    </sbdh:Receiver>
    <sbdh:DocumentIdentification>
        <sbdh:Standard>EPCglobal</sbdh:Standard>
        <sbdh:TypeVersion>1.0</sbdh:TypeVersion>
        <sbdh:InstanceIdentifier>1234567888</sbdh:InstanceIdentifier>
        <sbdh:Type>Events</sbdh:Type>
        <sbdh:CreationDateAndTime>2014-04-04T15:14:27.574-04:00</sbdh:CreationDateAndTime>
    </sbdh:DocumentIdentification>
</sbdh:StandardBusinessDocumentHeader>
<extension>
    <EPCISMasterData>
        <VocabularyList>
            <Vocabulary type="urn:epcglobal:epcis:vtype:EPCClass">
                <VocabularyElementList>
                    <VocabularyElement id="urn:epc:class:lgtin:030000.0000001.L6">
                        <attribute id="urn:epcglobal:cbv:mda#itemExpirationDate">2017-12-
31</attribute>
                    </VocabularyElement>
                    <VocabularyElement id="urn:epc:idpat:sgtin:030000.0000001.*">
                        <attribute
id="urn:epcglobal:cbv:mda#additionalTradeItemIdentification">00000000001</attribute>
                        <attribute
id="urn:epcglobal:cbv:mda#additionalTradeItemIdentificationTypeCode">FDA_NDC_11</attribute>
                        <attribute
id="urn:epcglobal:cbv:mda#regulatedProductName">Epcistra</attribute>
                        <attribute
id="urn:epcglobal:cbv:mda#manufacturerOfTradeItemPartyName">GS1 Pharma LLC</attribute>
                        <attribute id="urn:epcglobal:cbv:mda#dosageFormType">PILL</attribute>
                        <attribute
id="urn:epcglobal:cbv:mda#strengthDescription">100mg</attribute>
                        <attribute id="urn:epcglobal:cbv:mda#netContentDescription">500
pills</attribute>
                    </VocabularyElement>
                </VocabularyElementList>
            </Vocabulary>
            <Vocabulary type="urn:epcglobal:epcis:vtype:Location">
                <VocabularyElementList>
                    <VocabularyElement id="urn:epc:id:sgln:030000.000000.0">
                        <attribute id="urn:epcglobal:cbv:mda#name">GS1 Pharma LLC</attribute>
                        <attribute id="urn:epcglobal:cbv:mda#streetAddressOne">1295 S George
Ave</attribute>
                        <attribute id="urn:epcglobal:cbv:mda#streetAddressTwo">Room
378</attribute>
                        <attribute id="urn:epcglobal:cbv:mda#city">Washington</attribute>
                        <attribute id="urn:epcglobal:cbv:mda#state">DC</attribute>
                        <attribute id="urn:epcglobal:cbv:mda#postalCode">12345-
6789</attribute>
                        <attribute id="urn:epcglobal:cbv:mda#countryCode">US</attribute>
                    </VocabularyElement>
                    <VocabularyElement id="urn:epc:id:sgln:0614141.00000.0">
                        <attribute id="urn:epcglobal:cbv:mda#name">GS1 Drug Distro
LLC</attribute>
                        <attribute id="urn:epcglobal:cbv:mda#streetAddressOne">230 Park Ave
S</attribute>
                        <attribute id="urn:epcglobal:cbv:mda#city">New York</attribute>
                        <attribute id="urn:epcglobal:cbv:mda#state">NY</attribute>
                        <attribute id="urn:epcglobal:cbv:mda#postalCode">10003-
1502</attribute>
                        <attribute id="urn:epcglobal:cbv:mda#countryCode">US</attribute>

```

```

        </VocabularyElement>
      </VocabularyElementList>
    </Vocabulary>
  </VocabularyList>
</EPCISMasterData>
</extension>
<gslushc:dscsaTransactionStatement>
  <gslushc:affirmTransactionStatement>true</gslushc:affirmTransactionStatement>
  <gslushc:legalNotice>Seller has complied with each applicable subsection of FDCA Sec.
581 (27) (A) - (G).</gslushc:legalNotice>
</gslushc:dscsaTransactionStatement>
</EPCISHeader>
<EPCISBody>
  <EventList>
    <!-- Transaction Information (TI) -->
    <ObjectEvent>
      <eventTime>2014-04-01T10:11:12Z</eventTime>
      <eventTimeZoneOffset>-05:00</eventTimeZoneOffset>
      <epcList/>
      <action>OBSERVE</action>
      <bizStep>urn:epcglobal:cbv:bizstep:shipping</bizStep>
      <disposition>urn:epcglobal:cbv:disp:in_transit</disposition>
      <readPoint>
        <id>urn:epc:id:sgln:030000.000000.0</id>
      </readPoint>
      <extension>
        <quantityList>
          <!-- In this example, the EPCIS quantityElement data structure contains the
lgtin for the lowest saleable unit (LSU) and the quantity value is given in terms of LSUs. For
this example scenario, each ordered case contains 12 LSUs. Hence, the quantity value will be
computed by multiplying the order case quantity with 12 LSUs. -->
          <quantityElement>
            <epcClass>urn:epc:class:lgtin:030000.0000001.L6</epcClass>
            <quantity>24</quantity>
          </quantityElement>
        </quantityList>
        <sourceList>
          <source
type="urn:epcglobal:cbv:sdt:owning_party">urn:epc:id:sgln:030000.000000.0</source>
        </sourceList>
        <destinationList>
          <destination
type="urn:epcglobal:cbv:sdt:owning_party">urn:epc:id:sgln:0614141.00000.0</destination>
        </destinationList>
      </extension>
    </ObjectEvent>
  </EventList>
</EPCISBody>
</epcis:EPCISDocument>

```

### 12.3.1.5 Sample XML: Buyer Receives Product (2nd Receipt )

Reference File: <https://resources.gs1us.org/Portals/0/xml/LotException-LotNumberDiscrepancyKeep-BuyerReceives-2nd.xml>

```

<?xml version="1.0" encoding="UTF-8"?>
<!-- Lot Exception LotNumberDiscrepancy (Keep) - Buyer Receives Product (2nd Receipt) -->
<!-- After receiving corrected DSCSA supporting data for 2 cases of lot#6, Buyer receives the
2 cases into inventory -->

```

```

<epcis:EPCISDocument xmlns:cbvmda="urn:epcglobal:cbv:mda"
xmlns:sbdh="http://www.unece.org/cefact/namespaces/StandardBusinessDocumentHeader"
xmlns:gslushc="http://epcis.gs1us.org/hc/ns" xmlns:epcis="urn:epcglobal:epcis:xsd:1"
schemaVersion="1.2" xsi:schemaLocation="urn:epcglobal:epcis:xsd:1 EPCglobal-epcis-1_2.xsd"
xmlns:xsi="http://www.w3.org/2001/XMLSchema-instance" creationDate="2014-04-05T15:14:27.574-
04:00">
  <EPCISHeader>
    <sbdh:StandardBusinessDocumentHeader>
      <sbdh:HeaderVersion>1.0</sbdh:HeaderVersion>
      <sbdh:Sender>
        <sbdh:Identifier
Authority="SGLN">urn:epc:id:sgln:0614141.00000.0</sbdh:Identifier>
        </sbdh:Sender>
      <sbdh:Receiver>
        <sbdh:Identifier
Authority="SGLN">urn:epc:id:sgln:0614141.11111.0</sbdh:Identifier>
        </sbdh:Receiver>
      <sbdh:DocumentIdentification>
        <sbdh:Standard>EPCglobal</sbdh:Standard>
        <sbdh:TypeVersion>1.0</sbdh:TypeVersion>
        <sbdh:InstanceIdentifier>1234567889</sbdh:InstanceIdentifier>
        <sbdh:Type>Events</sbdh:Type>
        <sbdh:CreationDateAndTime>2014-04-05T15:14:27.574-04:00</sbdh:CreationDateAndTime>
      </sbdh:DocumentIdentification>
    </sbdh:StandardBusinessDocumentHeader>
    <extension>
      <EPCISMasterData>
        <VocabularyList>
          <Vocabulary type="urn:epcglobal:epcis:vtype:EPCClass">
            <VocabularyElementList>
              <VocabularyElement id="urn:epc:class:lgtin:030000.0000001.L6">
                <attribute id="urn:epcglobal:cbv:mda#itemExpirationDate">2017-10-
31</attribute>
              </VocabularyElement>
              <VocabularyElement id="urn:epc:idpat:sgtin:030000.0000001.*">
                <attribute
id="urn:epcglobal:cbv:mda#additionalTradeItemIdentification">00000000001</attribute>
                <attribute
id="urn:epcglobal:cbv:mda#additionalTradeItemIdentificationTypeCode">FDA_NDC_11</attribute>
                <attribute
id="urn:epcglobal:cbv:mda#regulatedProductName">Epcistra</attribute>
                <attribute
id="urn:epcglobal:cbv:mda#manufacturerOfTradeItemPartyName">GS1 Pharma LLC</attribute>
                <attribute id="urn:epcglobal:cbv:mda#dosageFormType">PILL</attribute>
                <attribute
id="urn:epcglobal:cbv:mda#strengthDescription">100mg</attribute>
                <attribute id="urn:epcglobal:cbv:mda#netContentDescription">500
pills</attribute>
              </VocabularyElement>
            </VocabularyElementList>
          </Vocabulary>
          <Vocabulary type="urn:epcglobal:epcis:vtype:Location">
            <VocabularyElementList>
              <VocabularyElement id="urn:epc:id:sgln:030000.000000.0">
                <attribute id="urn:epcglobal:cbv:mda#name">GS1 Pharma LLC</attribute>
                <attribute id="urn:epcglobal:cbv:mda#streetAddressOne">1295 S George
Ave</attribute>
                <attribute id="urn:epcglobal:cbv:mda#streetAddressTwo">Room
378</attribute>
                <attribute id="urn:epcglobal:cbv:mda#city">Washington</attribute>
                <attribute id="urn:epcglobal:cbv:mda#state">DC</attribute>
            </VocabularyElementList>
          </Vocabulary>
        </EPCISMasterData>
      </extension>
    </epcis:EPCISDocument>

```

```

        <attribute id="urn:epcglobal:cbv:mda#postalCode">12345-
6789</attribute>
        <attribute id="urn:epcglobal:cbv:mda#countryCode">US</attribute>
    </VocabularyElement>
    <VocabularyElement id="urn:epc:id:sgln:0614141.00000.0">
        <attribute id="urn:epcglobal:cbv:mda#name">GS1 Drug Distro
LLC</attribute>
        <attribute id="urn:epcglobal:cbv:mda#streetAddressOne">230 Park Ave
S</attribute>
        <attribute id="urn:epcglobal:cbv:mda#city">New York</attribute>
        <attribute id="urn:epcglobal:cbv:mda#state">NY</attribute>
        <attribute id="urn:epcglobal:cbv:mda#postalCode">10003-
1502</attribute>
        <attribute id="urn:epcglobal:cbv:mda#countryCode">US</attribute>
    </VocabularyElement>
</VocabularyElementList>
</Vocabulary>
</VocabularyList>
</EPCISMasterData>
</extension>
</EPCISHeader>
<EPCISBody>
    <EventList>
        <ObjectEvent>
            <eventTime>2014-04-05T10:11:12Z</eventTime>
            <eventTimeZoneOffset>-05:00</eventTimeZoneOffset>
            <epcList/>
            <action>OBSERVE</action>
            <bizStep>urn:epcglobal:cbv:bizstep:receiving</bizStep>
            <disposition>urn:epcglobal:cbv:disp:in_progress</disposition>
            <readPoint>
                <id>urn:epc:id:sgln:0614141.00000.0</id>
            </readPoint>
            <extension>
                <quantityList>
                    <!-- In this example, the EPCIS quantityElement data structure contains the
lgtn for the lowest saleable unit (LSU) and the quantity value is given in terms of LSUs. For
this example scenario, each ordered case contains 12 LSUs. Hence, the quantity value will be
computed by multiplying the order case quantity with 12 LSUs. -->
                    <quantityElement>
                        <epcClass>urn:epc:class:lgtn:030000.0000001.L6</epcClass>
                        <quantity>24</quantity>
                    </quantityElement>
                </quantityList>
                <sourceList>
                    <source
type="urn:epcglobal:cbv:sdt:owning_party">urn:epc:id:sgln:030000.000000.0</source>
                </sourceList>
                <destinationList>
                    <destination
type="urn:epcglobal:cbv:sdt:owning_party">urn:epc:id:sgln:0614141.00000.0</destination>
                </destinationList>
            </extension>
        </ObjectEvent>
    </EventList>
</EPCISBody>
</epcis:EPCISDocument>

```

## 12.3.2 Do Not Keep the Item

- 
**Note:** In this scenario, the buyer returns the 2 lowest saleable units (LSUs) whose lot number does not match the lot number value in the EPCIS shipment event. While the outcome of the two lot number discrepancy scenarios varies, the return process variation is not modeled in the sample XML because this guideline focuses on DSCSA related exchanges only.

### 12.3.2.1 Sample XML: Exchange1 - Seller → Buyer

- 
**Note:** The message content of *Exchange1 of Seller -> Buyer* in this example is identical to the content of the *Exchange1 of Seller -> Buyer* in the [Lot Number Discrepancy \(Keep the Item\)](#) example.

Reference File: <https://resources.gs1us.org/Portals/0/xml/LotException-LotNumberDiscrepancyDontKeep-SellerExchange1.xml>

```
<?xml version="1.0" encoding="UTF-8"?>
<!-- Lot Exception: LotNumberDiscrepancy (Don't Keep) - Exchange1: Seller -> Buyer-->
<!-- Buyer orders five cases and five cases arrive; however, the lot number on the cases do not
match
the lot number on the EPCIS Shipping Event.
Seller physically shipped 3 cases of Lot #5 and 2 cases of Lot#6 . Contrastingly, the
Seller's IT system reflects all 5 cases of lot #5 were shipped. -->
<!-- Note: This Seller -> Buyer transaction in this example is identical to the Seller ->
Buyer content for LotNumberDiscrepancy (Keep) - Exchange1 -->
<epcis:EPCISDocument xmlns:cbvmda="urn:epcglobal:cbv:mda"
xmlns:sbdh="http://www.unece.org/cefact/namespaces/StandardBusinessDocumentHeader"
xmlns:gslushc="http://epcis.gs1us.org/hc/ns" xmlns:epcis="urn:epcglobal:epcis:xsd:1"
schemaVersion="1.2" xsi:schemaLocation="urn:epcglobal:epcis:xsd:1 EPCglobal-epcis-1_2.xsd"
xmlns:xsi="http://www.w3.org/2001/XMLSchema-instance" creationDate="2014-04-01T15:14:27.574-
04:00">
  <EPCISHeader>
    <sbdh:StandardBusinessDocumentHeader>
      <sbdh:HeaderVersion>1.0</sbdh:HeaderVersion>
      <sbdh:Sender>
        <sbdh:Identifier
Authority="SGLN">urn:epc:id:sgln:030000.000000.0</sbdh:Identifier>
      </sbdh:Sender>
      <sbdh:Receiver>
        <sbdh:Identifier
Authority="SGLN">urn:epc:id:sgln:0614141.000000.0</sbdh:Identifier>
      </sbdh:Receiver>
      <sbdh:DocumentIdentification>
        <sbdh:Standard>EPCglobal</sbdh:Standard>
        <sbdh:TypeVersion>1.0</sbdh:TypeVersion>
        <sbdh:InstanceIdentifier>1234567885</sbdh:InstanceIdentifier>
        <sbdh:Type>Events</sbdh:Type>
        <sbdh:CreationDateAndTime>2014-04-01T15:14:27.574-04:00</sbdh:CreationDateAndTime>
      </sbdh:DocumentIdentification>
    </sbdh:StandardBusinessDocumentHeader>
    <extension>
      <EPCISMasterData>
        <VocabularyList>
          <Vocabulary type="urn:epcglobal:epcis:vtype:EPCClass">
            <VocabularyElementList>
              <VocabularyElement id="urn:epc:class:lgtin:030000.0000001.L5">
```



```

        <attribute id="urn:epcglobal:cbv:mda#itemExpirationDate">2017-10-
31</attribute>
        </VocabularyElement>
        <VocabularyElement id="urn:epc:idpat:sgtin:030000.0000001.*">
        <attribute
id="urn:epcglobal:cbv:mda#additionalTradeItemIdentification">00000000001</attribute>
        <attribute
id="urn:epcglobal:cbv:mda#additionalTradeItemIdentificationTypeCode">FDA_NDC_11</attribute>
        <attribute
id="urn:epcglobal:cbv:mda#regulatedProductName">Epcistra</attribute>
        <attribute
id="urn:epcglobal:cbv:mda#manufacturerOfTradeItemPartyName">GS1 Pharma LLC</attribute>
        <attribute id="urn:epcglobal:cbv:mda#dosageFormType">PILL</attribute>
        <attribute
id="urn:epcglobal:cbv:mda#strengthDescription">100mg</attribute>
        <attribute id="urn:epcglobal:cbv:mda#netContentDescription">500
pills</attribute>
        </VocabularyElement>
    </VocabularyElementList>
</Vocabulary>
<Vocabulary type="urn:epcglobal:epcis:vtype:Location">
    <VocabularyElementList>
        <VocabularyElement id="urn:epc:id:sgln:030000.000000.0">
        <attribute id="urn:epcglobal:cbv:mda#name">GS1 Pharma LLC</attribute>
        <attribute id="urn:epcglobal:cbv:mda#streetAddressOne">1295 S George
Ave</attribute>
        <attribute id="urn:epcglobal:cbv:mda#streetAddressTwo">Room
378</attribute>
        <attribute id="urn:epcglobal:cbv:mda#city">Washington</attribute>
        <attribute id="urn:epcglobal:cbv:mda#state">DC</attribute>
        <attribute id="urn:epcglobal:cbv:mda#postalCode">12345-
6789</attribute>
        <attribute id="urn:epcglobal:cbv:mda#countryCode">US</attribute>
    </VocabularyElement>
    <VocabularyElement id="urn:epc:id:sgln:0614141.00000.0">
        <attribute id="urn:epcglobal:cbv:mda#name">GS1 Drug Distro
LLC</attribute>
        <attribute id="urn:epcglobal:cbv:mda#streetAddressOne">230 Park Ave
S</attribute>
        <attribute id="urn:epcglobal:cbv:mda#city">New York</attribute>
        <attribute id="urn:epcglobal:cbv:mda#state">NY</attribute>
        <attribute id="urn:epcglobal:cbv:mda#postalCode">10003-
1502</attribute>
        <attribute id="urn:epcglobal:cbv:mda#countryCode">US</attribute>
    </VocabularyElement>
    </VocabularyElementList>
</Vocabulary>
</VocabularyList>
</EPCISMasterData>
</extension>
<gslushc:dscsaTransactionStatement>
    <gslushc:affirmTransactionStatement>true</gslushc:affirmTransactionStatement>
    <gslushc:legalNotice>Seller has complied with each applicable subsection of FDCA Sec.
581 (27) (A) - (G).</gslushc:legalNotice>
</gslushc:dscsaTransactionStatement>
</EPCISHeader>
<EPCISBody>
    <EventList>
        <!-- Transaction Information (TI) -->
        <ObjectEvent>
            <eventTime>2014-04-01T10:11:12Z</eventTime>

```



```

<eventTimeZoneOffset>-05:00</eventTimeZoneOffset>
<epcList/>
<action>OBSERVE</action>
<bizStep>urn:epcglobal:cbv:bizstep:shipping</bizStep>
<disposition>urn:epcglobal:cbv:disp:in_transit</disposition>
<readPoint>
  <id>urn:epc:id:sgln:030000.000000.0</id>
</readPoint>
<extension>
  <quantityList>
    <!-- In this example, the EPCIS quantityElement data structure contains the
lgtn for the lowest saleable unit (LSU) and the quantity value is given in terms of LSUs. For
this example scenario,each ordered case contains 12 LSUs.Hence, the quantity value will be
computed by multiplying the order case quantity with 12 LSUs. -->
    <quantityElement>
      <epcClass>urn:epc:class:lgtn:030000.0000001.L5</epcClass>
      <quantity>60</quantity>
    </quantityElement>
  </quantityList>
  <sourceList>
    <source
type="urn:epcglobal:cbv:sdt:owning_party">urn:epc:id:sgln:030000.000000.0</source>
  </sourceList>
  <destinationList>
    <destination
type="urn:epcglobal:cbv:sdt:owning_party">urn:epc:id:sgln:0614141.00000.0</destination>
  </destinationList>
</extension>
</ObjectEvent>
</EventList>
</EPCISBody>
</epcis:EPCISDocument>

```

### 12.3.2.2 Sample XML: Buyer Receives Product



**Note:** The message content of this example is identical to the content of the *Buyer Receives Product* in the [Lot Number Discrepancy \(Keep the Item\)](#) example.

Reference File: <https://resources.gs1us.org/Portals/0/xml/LotException-LotNumberDiscrepancyDontKeep-BuyerReceives-1st.xml>

```

<?xml version="1.0" encoding="UTF-8"?>
<!-- Lot Exception: LotNumberDiscrepancy (Don't Keep) - Buyer Receives Product (First Receipt) -->
<!--Buyer receives 3 of the 5 cases with supporting DSCSA data listing lot#5 to match the 3
physical cases that arrived. -->
<!-- Note: This Receiving transaction in this example is identical to the content for
LotNumberDiscrepancy (Keep) - Buyer Receives Product (First Receipt) -->
<epcis:EPCISDocument xmlns:cbvmda="urn:epcglobal:cbv:mda"
xmlns:sbdh="http://www.unece.org/cefact/namespaces/StandardBusinessDocumentHeader"
xmlns:gslushc="http://epcis.gslus.org/hc/ns" xmlns:epcis="urn:epcglobal:epcis:xsd:1"
schemaVersion="1.2" xsi:schemaLocation="urn:epcglobal:epcis:xsd:1 EPCglobal-epcis-1_2.xsd"
xmlns:xsi="http://www.w3.org/2001/XMLSchema-instance" creationDate="2014-04-02T15:14:27.574-
04:00">
  <EPCISHeader>
    <sbdh:StandardBusinessDocumentHeader>
      <sbdh:HeaderVersion>1.0</sbdh:HeaderVersion>
      <sbdh:Sender>

```

```

        <sbdh:Identifier
Authority="SGLN">urn:epc:id:sgln:0614141.00000.0</sbdh:Identifier>
    </sbdh:Sender>
    <sbdh:Receiver>
        <sbdh:Identifier
Authority="SGLN">urn:epc:id:sgln:0614141.11111.0</sbdh:Identifier>
    </sbdh:Receiver>
    <sbdh:DocumentIdentification>
        <sbdh:Standard>EPCglobal</sbdh:Standard>
        <sbdh:TypeVersion>1.0</sbdh:TypeVersion>
        <sbdh:InstanceIdentifier>1234567886</sbdh:InstanceIdentifier>
        <sbdh:Type>Events</sbdh:Type>
        <sbdh:CreationDateAndTime>2014-04-02T15:14:27.574-04:00</sbdh:CreationDateAndTime>
    </sbdh:DocumentIdentification>
</sbdh:StandardBusinessDocumentHeader>
<extension>
    <EPCISMasterData>
        <VocabularyList>
            <Vocabulary type="urn:epcglobal:epcis:vtype:EPCClass">
                <VocabularyElementList>
                    <VocabularyElement id="urn:epc:class:lgtin:030000.0000001.L5">
31</attribute>
                        <attribute id="urn:epcglobal:cbv:mda#itemExpirationDate">2017-10-
                            </VocabularyElement>
                            <VocabularyElement id="urn:epc:idpat:sgtin:030000.0000001.*">
                                <attribute
id="urn:epcglobal:cbv:mda#additionalTradeItemIdentification">00000000001</attribute>
                                    <attribute
id="urn:epcglobal:cbv:mda#additionalTradeItemIdentificationTypeCode">FDA_NDC_11</attribute>
                                        <attribute
id="urn:epcglobal:cbv:mda#regulatedProductName">Epcistra</attribute>
                                            <attribute
id="urn:epcglobal:cbv:mda#manufacturerOfTradeItemPartyName">GS1 Pharma LLC</attribute>
                                                <attribute id="urn:epcglobal:cbv:mda#dosageFormType">PILL</attribute>
                                                    <attribute
id="urn:epcglobal:cbv:mda#strengthDescription">100mg</attribute>
                                                        <attribute id="urn:epcglobal:cbv:mda#netContentDescription">500
pill</attribute>
                                                            </VocabularyElement>
                                                        </VocabularyElementList>
                                                    </Vocabulary>
                                                <Vocabulary type="urn:epcglobal:epcis:vtype:Location">
                                                    <VocabularyElementList>
                                                        <VocabularyElement id="urn:epc:id:sgln:030000.000000.0">
                    <attribute id="urn:epcglobal:cbv:mda#name">GS1 Pharma LLC</attribute>
                    <attribute id="urn:epcglobal:cbv:mda#streetAddressOne">1295 S George
Ave</attribute>
                    <attribute id="urn:epcglobal:cbv:mda#streetAddressTwo">Room
378</attribute>
                    <attribute id="urn:epcglobal:cbv:mda#city">Washington</attribute>
                    <attribute id="urn:epcglobal:cbv:mda#state">DC</attribute>
                    <attribute id="urn:epcglobal:cbv:mda#postalCode">12345-
6789</attribute>
                    <attribute id="urn:epcglobal:cbv:mda#countryCode">US</attribute>
                </VocabularyElement>
                <VocabularyElement id="urn:epc:id:sgln:0614141.00000.0">
                    <attribute id="urn:epcglobal:cbv:mda#name">GS1 Drug Distro
LLC</attribute>
                    <attribute id="urn:epcglobal:cbv:mda#streetAddressOne">230 Park Ave
S</attribute>
                    <attribute id="urn:epcglobal:cbv:mda#city">New York</attribute>

```

```

1502</attribute>
    <attribute id="urn:epcglobal:cbv:mda#state">NY</attribute>
    <attribute id="urn:epcglobal:cbv:mda#postalCode">10003-
    <attribute id="urn:epcglobal:cbv:mda#countryCode">US</attribute>
  </VocabularyElement>
</VocabularyElementList>
</Vocabulary>
</VocabularyList>
</EPCISMasterData>
</extension>
</EPCISHeader>
<EPCISBody>
  <EventList>
    <ObjectEvent>
      <eventTime>2014-04-02T10:11:12Z</eventTime>
      <eventTimeZoneOffset>-05:00</eventTimeZoneOffset>
      <epcList/>
      <action>OBSERVE</action>
      <bizStep>urn:epcglobal:cbv:bizstep:receiving</bizStep>
      <disposition>urn:epcglobal:cbv:disp:in_progress</disposition>
      <readPoint>
        <id>urn:epc:id:sgln:0614141.00000.0</id>
      </readPoint>
      <extension>
        <quantityList>
          <!-- In this example, the EPCIS quantityElement data structure contains the
          lgtin for the lowest saleable unit (LSU) and the quantity value is given in terms of LSUs. For
          this example scenario, each ordered case contains 12 LSUs. Hence, the quantity value will be
          computed by multiplying the order case quantity with 12 LSUs. -->
          <quantityElement>
            <epcClass>urn:epc:class:lgtin:030000.0000001.L5</epcClass>
            <quantity>36</quantity>
          </quantityElement>
        </quantityList>
        <sourceList>
          <source
type="urn:epcglobal:cbv:sdt:owning_party">urn:epc:id:sgln:030000.000000.0</source>
        </sourceList>
        <destinationList>
          <destination
type="urn:epcglobal:cbv:sdt:owning_party">urn:epc:id:sgln:0614141.00000.0</destination>
        </destinationList>
      </extension>
    </ObjectEvent>
  </EventList>
</EPCISBody>
</epcis:EPCISDocument>

```

### 12.3.2.3 Sample XML: Seller Corrects Shipment Data



**Note:** The message content of *Seller Corrects Shipment Data* in this example is identical to the content of the *Seller Corrects Shipment Data* in the [Lot Number Discrepancy \(Keep the Item\)](#) example.

Reference File: <https://resources.gs1us.org/Portals/0/xml/LotException-LotNumberDiscrepancyDontKeep-SellerCorrectsShipmentData.xml>

```

<?xml version="1.0" encoding="UTF-8"?>
<!-- Lot Exception: LotNumberDiscrepancy (Don't Keep) - Seller corrects shipment data -->

```

```

<!-- Seller investigates discrepancy and resolves issue by generating voidShipping event for
the 2 cases of lot#5 -->
<!-- Note: The voidshipping transaction in this example is identical to the content for
LotNumberDiscrepancy (Keep) - Seller corrects shipment data -->
<epcis:EPCISDocument xmlns:cbvmda="urn:epcglobal:cbv:mda"
xmlns:sbdh="http://www.unece.org/cefact/namespaces/StandardBusinessDocumentHeader"
xmlns:gslushc="http://epcis.gslus.org/hc/ns" xmlns:epcis="urn:epcglobal:epcis:xsd:1"
schemaVersion="1.2" xsi:schemaLocation="urn:epcglobal:epcis:xsd:1 EPCglobal-epcis-1_2.xsd"
xmlns:xsi="http://www.w3.org/2001/XMLSchema-instance" creationDate="2014-04-03T15:14:27.574-
04:00">
  <EPCISHeader>
    <sbdh:StandardBusinessDocumentHeader>
      <sbdh:HeaderVersion>1.0</sbdh:HeaderVersion>
      <sbdh:Sender>
        <sbdh:Identifier
Authority="SGLN">urn:epc:id:sgln:030000.000000.0</sbdh:Identifier>
        </sbdh:Sender>
      <sbdh:Receiver>
        <sbdh:Identifier
Authority="SGLN">urn:epc:id:sgln:030000.000001.0</sbdh:Identifier>
        </sbdh:Receiver>
      <sbdh:DocumentIdentification>
        <sbdh:Standard>EPCglobal</sbdh:Standard>
        <sbdh:TypeVersion>1.0</sbdh:TypeVersion>
        <sbdh:InstanceIdentifier>1234567887</sbdh:InstanceIdentifier>
        <sbdh:Type>Events</sbdh:Type>
        <sbdh:CreationDateAndTime>2014-04-03T15:14:27.574-04:00</sbdh:CreationDateAndTime>
      </sbdh:DocumentIdentification>
    </sbdh:StandardBusinessDocumentHeader>
    <extension>
      <EPCISMasterData>
        <VocabularyList>
          <Vocabulary type="urn:epcglobal:epcis:vtype:EPCClass">
            <VocabularyElementList>
              <VocabularyElement id="urn:epc:class:lgtn:030000.0000001.L5">
                <attribute id="urn:epcglobal:cbv:mda#itemExpirationDate">2017-10-
31</attribute>
              </VocabularyElement>
              <VocabularyElement id="urn:epc:idpat:sgtin:030000.0000001.*">
                <attribute
id="urn:epcglobal:cbv:mda#additionalTradeItemIdentification">00000000001</attribute>
                <attribute
id="urn:epcglobal:cbv:mda#additionalTradeItemIdentificationTypeCode">FDA_NDC_11</attribute>
                <attribute
id="urn:epcglobal:cbv:mda#regulatedProductName">Epcistra</attribute>
                <attribute
id="urn:epcglobal:cbv:mda#manufacturerOfTradeItemPartyName">GS1 Pharma LLC</attribute>
                <attribute id="urn:epcglobal:cbv:mda#dosageFormType">PILL</attribute>
                <attribute
id="urn:epcglobal:cbv:mda#strengthDescription">100mg</attribute>
                <attribute id="urn:epcglobal:cbv:mda#netContentDescription">500
pills</attribute>
              </VocabularyElement>
            </VocabularyElementList>
          </Vocabulary>
          <Vocabulary type="urn:epcglobal:epcis:vtype:Location">
            <VocabularyElementList>
              <VocabularyElement id="urn:epc:id:sgln:030000.000000.0">
                <attribute id="urn:epcglobal:cbv:mda#name">GS1 Pharma LLC</attribute>
                <attribute id="urn:epcglobal:cbv:mda#streetAddressOne">1295 S George
Ave</attribute>

```

```

        <attribute id="urn:epcglobal:cbv:mda#streetAddressTwo">Room
378</attribute>
        <attribute id="urn:epcglobal:cbv:mda#city">Washington</attribute>
        <attribute id="urn:epcglobal:cbv:mda#state">DC</attribute>
        <attribute id="urn:epcglobal:cbv:mda#postalCode">12345-
6789</attribute>
        <attribute id="urn:epcglobal:cbv:mda#countryCode">US</attribute>
    </VocabularyElement>
    <VocabularyElement id="urn:epc:id:sgln:0614141.00000.0">
        <attribute id="urn:epcglobal:cbv:mda#name">GS1 Drug Distro
LLC</attribute>
        <attribute id="urn:epcglobal:cbv:mda#streetAddressOne">230 Park Ave
S</attribute>
        <attribute id="urn:epcglobal:cbv:mda#city">New York</attribute>
        <attribute id="urn:epcglobal:cbv:mda#state">NY</attribute>
        <attribute id="urn:epcglobal:cbv:mda#postalCode">10003-
1502</attribute>
        <attribute id="urn:epcglobal:cbv:mda#countryCode">US</attribute>
    </VocabularyElement>
</VocabularyElementList>
</Vocabulary>
</VocabularyList>
</EPCISMasterData>
</extension>
</EPCISHeader>
<EPCISBody>
    <EventList>
        <ObjectEvent>
            <eventTime>2014-04-03T10:11:12Z</eventTime>
            <eventTimeZoneOffset>-05:00</eventTimeZoneOffset>
            <epcList/>
            <action>OBSERVE</action>
            <bizStep>urn:epcglobal:cbv:bizstep:void_shipping</bizStep>
            <disposition>urn:epcglobal:cbv:disp:in_progress</disposition>
            <readPoint>
                <id>urn:epc:id:sgln:030000.000000.0</id>
            </readPoint>
            <extension>
                <quantityList>
                    <!-- In this example, the EPCIS quantityElement data structure contains the
lgtin for the lowest saleable unit (LSU) and the quantity value is given in terms of LSUs. For
this example scenario, each ordered case contains 12 LSUs. Hence, the quantity value will be
computed by multiplying the order case quantity with 12 LSUs. -->
                    <quantityElement>
                        <epcClass>urn:epc:class:lgtin:030000.0000001.L5</epcClass>
                        <quantity>24</quantity>
                    </quantityElement>
                </quantityList>
            </extension>
            <sourceList>
                <source
type="urn:epcglobal:cbv:sdt:owning_party">urn:epc:id:sgln:030000.000000.0</source>
            </sourceList>
            <destinationList>
                <destination
type="urn:epcglobal:cbv:sdt:owning_party">urn:epc:id:sgln:0614141.00000.0</destination>
            </destinationList>
        </extension>
    </ObjectEvent>
</EventList>
</EPCISBody>
</epcis:EPCISDocument>

```

## 12.4 Concealed Overage

### 12.4.1 Keep the Extra Item

#### 12.4.1.1 Sample XML: Exchange1 - Seller → Buyer

Reference File: <https://resources.gs1us.org/Portals/0/xml/LotException-ConcealedOverageKeep-SellerExchange1.xml>

```
<?xml version="1.0" encoding="UTF-8"?>
<!-- Lot Exception: Concealed Overage (KeepExtra) - Exchange1: Seller -> Buyer-->
<!-- Buyer orders 1 case of 12 lowest saleable units (LSUs). The seller ships 1 case to the
buyer. Seller's IT system reflects there are 12 LSUs in the case.
In reality, there are 13 LSUs that got shipped in the 1 case -->
<epcis:EPCISDocument xmlns:cbvmda="urn:epcglobal:cbv:mda"
xmlns:sbdh="http://www.unece.org/cefact/namespaces/StandardBusinessDocumentHeader"
xmlns:gslushc="http://epcis.gslus.org/hc/ns" xmlns:epcis="urn:epcglobal:epcis:xsd:1"
schemaVersion="1.2" xsi:schemaLocation="urn:epcglobal:epcis:xsd:1 EPCglobal-epcis-1_2.xsd"
xmlns:xsi="http://www.w3.org/2001/XMLSchema-instance" creationDate="2014-04-01T15:14:27.574-
04:00">
  <EPCISHeader>
    <sbdh:StandardBusinessDocumentHeader>
      <sbdh:HeaderVersion>1.0</sbdh:HeaderVersion>
      <sbdh:Sender>
        <sbdh:Identifier
Authority="SGLN">urn:epc:id:sgln:030000.000000.0</sbdh:Identifier>
        </sbdh:Sender>
        <sbdh:Receiver>
          <sbdh:Identifier
Authority="SGLN">urn:epc:id:sgln:0614141.000000.0</sbdh:Identifier>
          </sbdh:Receiver>
        <sbdh:DocumentIdentification>
          <sbdh:Standard>EPCglobal</sbdh:Standard>
          <sbdh:TypeVersion>1.0</sbdh:TypeVersion>
          <sbdh:InstanceIdentifier>1234567870</sbdh:InstanceIdentifier>
          <sbdh:Type>Events</sbdh:Type>
          <sbdh:CreationDateAndTime>2014-04-01T15:14:27.574-04:00</sbdh:CreationDateAndTime>
        </sbdh:DocumentIdentification>
      </sbdh:StandardBusinessDocumentHeader>
      <extension>
        <EPCISMasterData>
          <VocabularyList>
            <Vocabulary type="urn:epcglobal:epcis:vtype:EPCClass">
              <VocabularyElementList>
                <VocabularyElement id="urn:epc:class:lgtin:030000.0000002.L1">
                  <attribute id="urn:epcglobal:cbv:mda#itemExpirationDate">2017-10-
31</attribute>
                </VocabularyElement>
                <!-- Product Master data attributes for an LSU -->
                <VocabularyElement id="urn:epc:idpat:sgtin:030000.0000002.*">
                  <attribute
id="urn:epcglobal:cbv:mda#additionalTradeItemIdentification">0000000002</attribute>
                  <attribute
id="urn:epcglobal:cbv:mda#additionalTradeItemIdentificationTypeCode">FDA_NDC_11</attribute>
                  <attribute
id="urn:epcglobal:cbv:mda#regulatedProductName">Epcistra</attribute>
                  <attribute
id="urn:epcglobal:cbv:mda#manufacturerOfTradeItemPartyName">GS1 Pharma LLC</attribute>
                  <attribute id="urn:epcglobal:cbv:mda#dosageFormType">PILL</attribute>
                </VocabularyElement>
              </VocabularyElementList>
            </Vocabulary>
          </EPCISMasterData>
        </extension>
      </EPCISHeader>
    </epcis:EPCISDocument>
  </epcis:EPCISDocument>
</epcis:EPCISDocument>
```

```

        <attribute
id="urn:epcglobal:cbv:mda#strengthDescription">100mg</attribute>
        <attribute id="urn:epcglobal:cbv:mda#netContentDescription">480
pills</attribute>
    </VocabularyElement>
</VocabularyElementList>
</Vocabulary>
<Vocabulary type="urn:epcglobal:epcis:vtype:Location">
    <VocabularyElementList>
        <VocabularyElement id="urn:epc:id:sgln:030000.000000.0">
            <attribute id="urn:epcglobal:cbv:mda#name">GS1 Pharma LLC</attribute>
            <attribute id="urn:epcglobal:cbv:mda#streetAddressOne">1295 S George
Ave</attribute>
            <attribute id="urn:epcglobal:cbv:mda#streetAddressTwo">Room
378</attribute>
            <attribute id="urn:epcglobal:cbv:mda#city">Washington</attribute>
            <attribute id="urn:epcglobal:cbv:mda#state">DC</attribute>
            <attribute id="urn:epcglobal:cbv:mda#postalCode">12345-
6789</attribute>
            <attribute id="urn:epcglobal:cbv:mda#countryCode">US</attribute>
        </VocabularyElement>
    <VocabularyElement id="urn:epc:id:sgln:0614141.000000.0">
        <attribute id="urn:epcglobal:cbv:mda#name">GS1 Drug Distro
LLC</attribute>
        <attribute id="urn:epcglobal:cbv:mda#streetAddressOne">230 Park Ave
S</attribute>
        <attribute id="urn:epcglobal:cbv:mda#city">New York</attribute>
        <attribute id="urn:epcglobal:cbv:mda#state">NY</attribute>
        <attribute id="urn:epcglobal:cbv:mda#postalCode">10003-
1502</attribute>
            <attribute id="urn:epcglobal:cbv:mda#countryCode">US</attribute>
        </VocabularyElement>
    </VocabularyElementList>
</Vocabulary>
</VocabularyList>
</EPCISMasterData>
</extension>
<gslushc:dscsaTransactionStatement>
    <gslushc:affirmTransactionStatement>true</gslushc:affirmTransactionStatement>
    <gslushc:legalNotice>Seller has complied with each applicable subsection of FDCA Sec.
581 (27) (A) - (G).</gslushc:legalNotice>
</gslushc:dscsaTransactionStatement>
</EPCISHeader>
<EPCISBody>
    <EventList>
        <!-- Transaction Information (TI) -->
        <ObjectEvent>
            <eventTime>2014-04-01T10:11:12Z</eventTime>
            <eventTimeZoneOffset>-05:00</eventTimeZoneOffset>
            <epcList/>
            <action>OBSERVE</action>
            <bizStep>urn:epcglobal:cbv:bizstep:shipping</bizStep>
            <disposition>urn:epcglobal:cbv:disp:in_transit</disposition>
            <readPoint>
                <id>urn:epc:id:sgln:030000.000000.0</id>
            </readPoint>
            <extension>
                <quantityList>
                    <!-- In this example, the EPCIS quantityElement data structure contains the
lgtin for the lowest saleable unit (LSU) and the quantity value is given in terms of LSUs.

```



For this example scenario, each ordered case contains 12 LSUs. Hence, the quantity value will be computed by multiplying the order case quantity with 12 LSUs. -->

```

    <quantityElement>
      <!-- Seller ships 1 case of 12 LSUs -->
      <epcClass>urn:epc:class:lgtin:030000.0000002.L1</epcClass>
      <quantity>12</quantity>
    </quantityElement>
  </quantityList>
  <sourceList>
    <source
type="urn:epcglobal:cbv:sdt:owning_party">urn:epc:id:sgln:030000.000000.0</source>
    </sourceList>
    <destinationList>
      <destination
type="urn:epcglobal:cbv:sdt:owning_party">urn:epc:id:sgln:0614141.00000.0</destination>
    </destinationList>
  </extension>
</ObjectEvent>
</EventList>
</EPCISBody>
</epcis:EPCISDocument>

```

### 12.4.1.2 Sample XML: Buyer Receives Product (1st Receipt)

Reference File: <https://resources.gs1us.org/Portals/0/xml/LotException-ConcealedOverageKeep-BuyerReceives-1st.xml>

```

<?xml version="1.0" encoding="UTF-8"?>
<!-- Lot Exception: Concealed Overage (KeepExtra) - Buyer Receives Product (First Receipt) -->
<!--Without opening the case, Buyer receives 1 case of 12 lowest saleable units (LSUs). -->
<epcis:EPCISDocument xmlns:cbvmda="urn:epcglobal:cbv:mda"
xmlns:sbdh="http://www.unece.org/cefact/namespaces/StandardBusinessDocumentHeader"
xmlns:gslushc="http://epcis.gs1us.org/hc/ns" xmlns:epcis="urn:epcglobal:epcis:xsd:1"
schemaVersion="1.2" xsi:schemaLocation="urn:epcglobal:epcis:xsd:1 EPCglobal-epcis-1_2.xsd"
xmlns:xsi="http://www.w3.org/2001/XMLSchema-instance" creationDate="2014-04-02T15:14:27.574-
04:00">
  <EPCISHeader>
    <sbdh:StandardBusinessDocumentHeader>
      <sbdh:HeaderVersion>1.0</sbdh:HeaderVersion>
      <sbdh:Sender>
        <sbdh:Identifier
Authority="SGLN">urn:epc:id:sgln:0614141.00000.0</sbdh:Identifier>
      </sbdh:Sender>
      <sbdh:Receiver>
        <sbdh:Identifier
Authority="SGLN">urn:epc:id:sgln:0614141.11111.0</sbdh:Identifier>
      </sbdh:Receiver>
      <sbdh:DocumentIdentification>
        <sbdh:Standard>EPCglobal</sbdh:Standard>
        <sbdh:TypeVersion>1.0</sbdh:TypeVersion>
        <sbdh:InstanceIdentifier>1234567871</sbdh:InstanceIdentifier>
        <sbdh:Type>Events</sbdh:Type>
        <sbdh:CreationDateAndTime>2014-04-02T15:14:27.574-04:00</sbdh:CreationDateAndTime>
      </sbdh:DocumentIdentification>
    </sbdh:StandardBusinessDocumentHeader>
    <extension>
      <EPCISMasterData>
        <VocabularyList>
          <Vocabulary type="urn:epcglobal:epcis:vtype:EPCClass">
            <VocabularyElementList>

```



```

31</attribute>
    <VocabularyElement id="urn:epc:class:lgtin:030000.0000002.L1">
      <attribute id="urn:epcglobal:cbv:mda#itemExpirationDate">2017-10-
    </VocabularyElement>
    <!-- Product Master data attributes for an LSU -->
    <VocabularyElement id="urn:epc:idpat:sgtin:030000.0000002.*">
      <attribute
id="urn:epcglobal:cbv:mda#additionalTradeItemIdentification">0000000002</attribute>
      <attribute
id="urn:epcglobal:cbv:mda#additionalTradeItemIdentificationTypeCode">FDA_NDC_11</attribute>
      <attribute
id="urn:epcglobal:cbv:mda#regulatedProductName">Epcistra</attribute>
      <attribute
id="urn:epcglobal:cbv:mda#manufacturerOfTradeItemPartyName">GS1 Pharma LLC</attribute>
      <attribute id="urn:epcglobal:cbv:mda#dosageFormType">PILL</attribute>
      <attribute
id="urn:epcglobal:cbv:mda#strengthDescription">100mg</attribute>
      <attribute id="urn:epcglobal:cbv:mda#netContentDescription">480
pills</attribute>
    </VocabularyElement>
  </VocabularyElementList>
</Vocabulary>
<Vocabulary type="urn:epcglobal:epcis:vtype:Location">
  <VocabularyElementList>
    <VocabularyElement id="urn:epc:id:sgln:030000.000000.0">
      <attribute id="urn:epcglobal:cbv:mda#name">GS1 Pharma LLC</attribute>
      <attribute id="urn:epcglobal:cbv:mda#streetAddressOne">1295 S George
Ave</attribute>
      <attribute id="urn:epcglobal:cbv:mda#streetAddressTwo">Room
378</attribute>
      <attribute id="urn:epcglobal:cbv:mda#city">Washington</attribute>
      <attribute id="urn:epcglobal:cbv:mda#state">DC</attribute>
      <attribute id="urn:epcglobal:cbv:mda#postalCode">12345-
6789</attribute>
      <attribute id="urn:epcglobal:cbv:mda#countryCode">US</attribute>
    </VocabularyElement>
    <VocabularyElement id="urn:epc:id:sgln:0614141.00000.0">
      <attribute id="urn:epcglobal:cbv:mda#name">GS1 Drug Distro
LLC</attribute>
      <attribute id="urn:epcglobal:cbv:mda#streetAddressOne">230 Park Ave
S</attribute>
      <attribute id="urn:epcglobal:cbv:mda#city">New York</attribute>
      <attribute id="urn:epcglobal:cbv:mda#state">NY</attribute>
      <attribute id="urn:epcglobal:cbv:mda#postalCode">10003-
1502</attribute>
      <attribute id="urn:epcglobal:cbv:mda#countryCode">US</attribute>
    </VocabularyElement>
  </VocabularyElementList>
</Vocabulary>
</VocabularyList>
</EPCISMasterData>
</extension>
</EPCISHeader>
<EPCISBody>
  <EventList>
    <ObjectEvent>
      <eventTime>2014-04-02T10:11:12Z</eventTime>
      <eventTimeZoneOffset>-05:00</eventTimeZoneOffset>
      <epcList/>
      <action>OBSERVE</action>
      <bizStep>urn:epcglobal:cbv:bizstep:receiving</bizStep>

```

```

<disposition>urn:epcglobal:cbv:disp:in_progress</disposition>
<readPoint>
  <id>urn:epc:id:sgln:0614141.00000.0</id>
</readPoint>
<extension>
  <quantityList>
    <!-- In this example, the EPCIS quantityElement data structure contains the
lgtin for the lowest saleable unit (LSU) and the quantity value is given in terms of LSUs. For
this example scenario, each ordered case contains 12 LSUs. Hence, the quantity value will be
computed by multiplying the order case quantity with 12 LSUs. -->
    <quantityElement>
      <!-- Buyer receives 1 case of 12 LSUs into inventory -->
      <epcClass>urn:epc:class:lgtin:030000.0000002.L1</epcClass>
      <quantity>12</quantity>
    </quantityElement>
  </quantityList>
  <sourceList>
    <source
type="urn:epcglobal:cbv:sdt:owning_party">urn:epc:id:sgln:030000.000000.0</source>
  </sourceList>
  <destinationList>
    <destination
type="urn:epcglobal:cbv:sdt:owning_party">urn:epc:id:sgln:0614141.00000.0</destination>
  </destinationList>
</extension>
</ObjectEvent>
</EventList>
</EPCISBody>
</epcis:EPCISDocument>

```

### 12.4.1.3 Sample XML: Exchange2 - Seller → Buyer

Reference File: <https://resources.gs1us.org/Portals/0/xml/LotException-ConcealedOverageKeep-SellerExchange2.xml>

```

<?xml version="1.0" encoding="UTF-8"?>
<!-- Lot Exception Concealed Overage (KeepExtra) - Exchange2: Seller -> Buyer -->
<!-- Upon opening the case, buyer discovers there are 13 LSUs instead of the expected 12 lowest
saleable units (LSUs) inside the case,
After getting notified and investigating the discrepancy, seller resolves issue by
generating Shipping Event for the 1 extra lowest saleable unit (LSU) -->
<epcis:EPCISDocument xmlns:cbvmda="urn:epcglobal:cbv:mda"
xmlns:sbdh="http://www.unece.org/cefact/namespaces/StandardBusinessDocumentHeader"
xmlns:gslushc="http://epcis.gs1us.org/hc/ns" xmlns:epcis="urn:epcglobal:epcis:xsd:1"
schemaVersion="1.2" xsi:schemaLocation="urn:epcglobal:epcis:xsd:1 EPCglobal-epcis-1_2.xsd"
xmlns:xsi="http://www.w3.org/2001/XMLSchema-instance" creationDate="2014-04-03T15:14:27.574-
04:00">
  <EPCISHeader>
    <sbdh:StandardBusinessDocumentHeader>
      <sbdh:HeaderVersion>1.0</sbdh:HeaderVersion>
      <sbdh:Sender>
        <sbdh:Identifier
Authority="SGLN">urn:epc:id:sgln:030000.000000.0</sbdh:Identifier>
      </sbdh:Sender>
      <sbdh:Receiver>
        <sbdh:Identifier
Authority="SGLN">urn:epc:id:sgln:0614141.00000.0</sbdh:Identifier>
      </sbdh:Receiver>
      <sbdh:DocumentIdentification>
        <sbdh:Standard>EPCglobal</sbdh:Standard>

```

```

    <sbdh:TypeVersion>1.0</sbdh:TypeVersion>
    <sbdh:InstanceIdentifier>1234567872</sbdh:InstanceIdentifier>
    <sbdh:Type>Events</sbdh:Type>
    <sbdh:CreationDateAndTime>2014-04-03T15:14:27.574-04:00</sbdh:CreationDateAndTime>
  </sbdh:DocumentIdentification>
</sbdh:StandardBusinessDocumentHeader>
<extension>
  <EPCISMasterData>
    <VocabularyList>
      <Vocabulary type="urn:epcglobal:epcis:vtype:EPCClass">
        <VocabularyElementList>
          <!-- GTIN B -->
          <VocabularyElement id="urn:epc:class:lgtn:030000.0000002.L1">
            <attribute id="urn:epcglobal:cbv:mda#itemExpirationDate">2017-10-
31</attribute>
          </VocabularyElement>
          <!-- including the Product Master data for the GTIN representing the
lowest saleable unit -->
          <VocabularyElement id="urn:epc:idpat:sgtin:030000.0000002.*">
            <attribute
id="urn:epcglobal:cbv:mda#additionalTradeItemIdentification">0000000002</attribute>
            <attribute
id="urn:epcglobal:cbv:mda#additionalTradeItemIdentificationTypeCode">FDA_NDC_11</attribute>
            <attribute
id="urn:epcglobal:cbv:mda#regulatedProductName">Epcistra</attribute>
            <attribute
id="urn:epcglobal:cbv:mda#manufacturerOfTradeItemPartyName">GS1 Pharma LLC</attribute>
            <attribute id="urn:epcglobal:cbv:mda#dosageFormType">PILL</attribute>
            <attribute
id="urn:epcglobal:cbv:mda#strengthDescription">100mg</attribute>
            <attribute id="urn:epcglobal:cbv:mda#netContentDescription">480
pills</attribute>
          </VocabularyElement>
        </VocabularyElementList>
      </Vocabulary>
      <Vocabulary type="urn:epcglobal:epcis:vtype:Location">
        <VocabularyElementList>
          <VocabularyElement id="urn:epc:id:sgln:030000.000000.0">
            <attribute id="urn:epcglobal:cbv:mda#name">GS1 Pharma LLC</attribute>
            <attribute id="urn:epcglobal:cbv:mda#streetAddressOne">1295 S George
Ave</attribute>
            <attribute id="urn:epcglobal:cbv:mda#streetAddressTwo">Room
378</attribute>
            <attribute id="urn:epcglobal:cbv:mda#city">Washington</attribute>
            <attribute id="urn:epcglobal:cbv:mda#state">DC</attribute>
            <attribute id="urn:epcglobal:cbv:mda#postalCode">12345-
6789</attribute>
            <attribute id="urn:epcglobal:cbv:mda#countryCode">US</attribute>
          </VocabularyElement>
          <VocabularyElement id="urn:epc:id:sgln:0614141.00000.0">
            <attribute id="urn:epcglobal:cbv:mda#name">GS1 Drug Distro
LLC</attribute>
            <attribute id="urn:epcglobal:cbv:mda#streetAddressOne">230 Park Ave
S</attribute>
            <attribute id="urn:epcglobal:cbv:mda#city">New York</attribute>
            <attribute id="urn:epcglobal:cbv:mda#state">NY</attribute>
            <attribute id="urn:epcglobal:cbv:mda#postalCode">10003-
1502</attribute>
            <attribute id="urn:epcglobal:cbv:mda#countryCode">US</attribute>
          </VocabularyElement>
        </VocabularyElementList>
      </Vocabulary>
    </VocabularyList>
  </EPCISMasterData>
</extension>

```

```

        </Vocabulary>
      </VocabularyList>
    </EPCISMasterData>
  </extension>
  <gslushc:dcsaTransactionStatement>
    <gslushc:affirmTransactionStatement>true</gslushc:affirmTransactionStatement>
    <gslushc:legalNotice>Seller has complied with each applicable subsection of FDCA Sec.
581 (27) (A) - (G).</gslushc:legalNotice>
  </gslushc:dcsaTransactionStatement>
</EPCISHeader>
<EPCISBody>
  <EventList>
    <!-- Transaction Information (TI) -->
    <ObjectEvent>
      <eventTime>2014-04-01T10:11:12Z</eventTime>
      <eventTimeZoneOffset>-05:00</eventTimeZoneOffset>
      <epcList/>
      <action>OBSERVE</action>
      <bizStep>urn:epcglobal:cbv:bizstep:shipping</bizStep>
      <disposition>urn:epcglobal:cbv:disp:in_transit</disposition>
      <readPoint>
        <id>urn:epc:id:sgln:030000.000000.0</id>
      </readPoint>
      <extension>
        <quantityList>
          <!-- In this example, the EPCIS quantityElement data structure contains the
lgtin for the lowest saleable unit (LSU) and the quantity value is given in terms of LSUs.
-->
          <quantityElement>
            <!-- Seller generates shipping event for 1 LSU to account for the 1 item
overage -->
            <epcClass>urn:epc:class:lgtin:030000.0000002.L1</epcClass>
            <quantity>1</quantity>
          </quantityElement>
        </quantityList>
        <sourceList>
          <source
type="urn:epcglobal:cbv:sdt:owning_party">urn:epc:id:sgln:030000.000000.0</source>
        </sourceList>
        <destinationList>
          <destination
type="urn:epcglobal:cbv:sdt:owning_party">urn:epc:id:sgln:0614141.00000.0</destination>
        </destinationList>
      </extension>
    </ObjectEvent>
  </EventList>
</EPCISBody>
</epcis:EPCISDocument>

```

#### 12.4.1.4 Sample XML: Buyer Receives Product (2nd Receipt)

Reference File: <https://resources.gs1us.org/Portals/0/xml/LotException-ConcealedOverageKeep-BuyerReceives-2nd.xml>

```

<?xml version="1.0" encoding="UTF-8"?>
<?xml version="1.0" encoding="UTF-8"?>
<!-- Lot Exception: Concealed Overage (KeepExtra) - Buyer Receives Product (2nd Receipt) -->
<!--After receiving supporting DSCSA data for the extra lowest saleable unit (LSU), Buyer
receives 1 LSU into inventory -->

```

```

<epcis:EPCISDocument xmlns:cbvmda="urn:epcglobal:cbv:mda"
xmlns:sbdh="http://www.unece.org/cefact/namespaces/StandardBusinessDocumentHeader"
xmlns:gslushc="http://epcis.gslus.org/hc/ns" xmlns:epcis="urn:epcglobal:epcis:xsd:1"
schemaVersion="1.2" xsi:schemaLocation="urn:epcglobal:epcis:xsd:1 EPCglobal-epcis-1_2.xsd"
xmlns:xsi="http://www.w3.org/2001/XMLSchema-instance" creationDate="2014-04-02T15:14:27.574-
04:00">
  <EPCISHeader>
    <sbdh:StandardBusinessDocumentHeader>
      <sbdh:HeaderVersion>1.0</sbdh:HeaderVersion>
      <sbdh:Sender>
        <sbdh:Identifier
Authority="SGLN">urn:epc:id:sgln:0614141.00000.0</sbdh:Identifier>
        </sbdh:Sender>
      <sbdh:Receiver>
        <sbdh:Identifier
Authority="SGLN">urn:epc:id:sgln:0614141.11111.0</sbdh:Identifier>
        </sbdh:Receiver>
      <sbdh:DocumentIdentification>
        <sbdh:Standard>EPCglobal</sbdh:Standard>
        <sbdh:TypeVersion>1.0</sbdh:TypeVersion>
        <sbdh:InstanceIdentifier>1234567873</sbdh:InstanceIdentifier>
        <sbdh:Type>Events</sbdh:Type>
        <sbdh:CreationDateAndTime>2014-04-02T15:14:27.574-04:00</sbdh:CreationDateAndTime>
      </sbdh:DocumentIdentification>
    </sbdh:StandardBusinessDocumentHeader>
    <extension>
      <EPCISMasterData>
        <VocabularyList>
          <Vocabulary type="urn:epcglobal:epcis:vtype:EPCClass">
            <VocabularyElementList>
              <VocabularyElement id="urn:epc:class:lgtin:030000.0000002.L1">
                <attribute id="urn:epcglobal:cbv:mda#itemExpirationDate">2017-10-
31</attribute>
              </VocabularyElement>
              <!-- including the Product Master data for the GTIN representing the
lowest saleable unit -->
              <VocabularyElement id="urn:epc:idpat:sgtin:030000.0000002.*">
                <attribute
id="urn:epcglobal:cbv:mda#additionalTradeItemIdentification">0000000002</attribute>
                <attribute
id="urn:epcglobal:cbv:mda#additionalTradeItemIdentificationTypeCode">FDA_NDC_11</attribute>
                <attribute
id="urn:epcglobal:cbv:mda#regulatedProductName">Epcistra</attribute>
                <attribute
id="urn:epcglobal:cbv:mda#manufacturerOfTradeItemPartyName">GS1 Pharma LLC</attribute>
                <attribute id="urn:epcglobal:cbv:mda#dosageFormType">PILL</attribute>
                <attribute
id="urn:epcglobal:cbv:mda#strengthDescription">100mg</attribute>
                <attribute id="urn:epcglobal:cbv:mda#netContentDescription">480
pills</attribute>
              </VocabularyElement>
            </VocabularyElementList>
          </Vocabulary>
          <Vocabulary type="urn:epcglobal:epcis:vtype:Location">
            <VocabularyElementList>
              <VocabularyElement id="urn:epc:id:sgln:030000.000000.0">
                <attribute id="urn:epcglobal:cbv:mda#name">GS1 Pharma LLC</attribute>
                <attribute id="urn:epcglobal:cbv:mda#streetAddressOne">1295 S George
Ave</attribute>
                <attribute id="urn:epcglobal:cbv:mda#streetAddressTwo">Room
378</attribute>
            </VocabularyElementList>
          </Vocabulary>
        </EPCISMasterData>
      </extension>
    </EPCISHeader>
  </EPCISDocument>

```

```

        <attribute id="urn:epcglobal:cbv:mda#city">Washington</attribute>
        <attribute id="urn:epcglobal:cbv:mda#state">DC</attribute>
        <attribute id="urn:epcglobal:cbv:mda#postalCode">12345-
6789</attribute>
        <attribute id="urn:epcglobal:cbv:mda#countryCode">US</attribute>
    </VocabularyElement>
    <VocabularyElement id="urn:epc:id:sgln:0614141.00000.0">
        <attribute id="urn:epcglobal:cbv:mda#name">GS1 Drug Distro
LLC</attribute>
        <attribute id="urn:epcglobal:cbv:mda#streetAddressOne">230 Park Ave
S</attribute>
        <attribute id="urn:epcglobal:cbv:mda#city">New York</attribute>
        <attribute id="urn:epcglobal:cbv:mda#state">NY</attribute>
        <attribute id="urn:epcglobal:cbv:mda#postalCode">10003-
1502</attribute>
        <attribute id="urn:epcglobal:cbv:mda#countryCode">US</attribute>
    </VocabularyElement>
</VocabularyElementList>
</Vocabulary>
</VocabularyList>
</EPCISMasterData>
</extension>
</EPCISHeader>
<EPCISBody>
    <EventList>
        <ObjectEvent>
            <eventTime>2014-04-02T10:11:12Z</eventTime>
            <eventTimeZoneOffset>-05:00</eventTimeZoneOffset>
            <epcList/>
            <action>OBSERVE</action>
            <bizStep>urn:epcglobal:cbv:bizstep:receiving</bizStep>
            <disposition>urn:epcglobal:cbv:disp:in_progress</disposition>
            <readPoint>
                <id>urn:epc:id:sgln:0614141.00000.0</id>
            </readPoint>
            <extension>
                <quantityList>
                    <!-- In this example, the EPCIS quantityElement data structure contains the
lgtin for the lowest saleable unit (LSU) and the quantity value is given in terms of LSUs.
                    -->
                    <quantityElement>
                        <!-- Buyer receives 1 LSU into inventory -->
                        <epcClass>urn:epc:class:lgtin:030000.0000002.L1</epcClass>
                        <quantity>1</quantity>
                    </quantityElement>
                </quantityList>
            </sourceList>
            <sourceList>
                <source
type="urn:epcglobal:cbv:sdt:owning_party">urn:epc:id:sgln:030000.000000.0</source>
            </sourceList>
            <destinationList>
                <destination
type="urn:epcglobal:cbv:sdt:owning_party">urn:epc:id:sgln:0614141.00000.0</destination>
            </destinationList>
        </extension>
    </ObjectEvent>
</EventList>
</EPCISBody>
</epcis:EPCISDocument>

```

## 12.4.2 Return the Extra Item

- ✓ **Note:** In this scenario, the buyer returns the 1 extra lowest saleable units (LSU) concealed in the case shipment. While the outcome of the concealed overage scenarios varies, the return process variation is not modeled in the sample XML because this guideline focuses on DSCSA related exchanges only.

### 12.4.2.1 Sample XML: Exchange1 - Seller → Buyer

- ✓ **Note:** The message content of *Exchange1 of Seller -> Buyer* in this example is identical to the content of the *Exchange1 of Seller -> Buyer* in the [Concealed Overage \(Keep the Extra Item\)](#) example.

Reference File: <https://resources.gs1us.org/Portals/0/xml/LotException-ConcealedOverageReturn-SellerExchange1.xml>

```
<?xml version="1.0" encoding="UTF-8"?>
<!-- Lot Exception: Concealed Overage (Return) - Exchange1: Seller -> Buyer-->
<!-- Buyer orders 1 case of 12 lowest saleable units (LSUs). The seller ships 1 case to the
buyer. Seller's IT system reflects there are 12 LSUs in the case.
In reality, there are 13 LSUs that got shipped in the 1 case. -->
<!-- Note: This Seller -> Buyer transaction in this example is identical to the Seller ->
Buyer content for Concealed Overage (KeepExtra) - Exchange1 -->
<epcis:EPCISDocument xmlns:cbvmda="urn:epcglobal:cbv:mda"
xmlns:sbdh="http://www.unece.org/cefact/namespaces/StandardBusinessDocumentHeader"
xmlns:gslushc="http://epcis.gs1us.org/hc/ns" xmlns:epcis="urn:epcglobal:epcis:xsd:1"
schemaVersion="1.2" xsi:schemaLocation="urn:epcglobal:epcis:xsd:1 EPCglobal-epcis-1_2.xsd"
xmlns:xsi="http://www.w3.org/2001/XMLSchema-instance" creationDate="2014-04-01T15:14:27.574-
04:00">
  <EPCISHeader>
    <sbdh:StandardBusinessDocumentHeader>
      <sbdh:HeaderVersion>1.0</sbdh:HeaderVersion>
      <sbdh:Sender>
        <sbdh:Identifier
Authority="SGLN">urn:epc:id:sgln:030000.000000.0</sbdh:Identifier>
        </sbdh:Sender>
      <sbdh:Receiver>
        <sbdh:Identifier
Authority="SGLN">urn:epc:id:sgln:0614141.000000.0</sbdh:Identifier>
        </sbdh:Receiver>
      <sbdh:DocumentIdentification>
        <sbdh:Standard>EPCglobal</sbdh:Standard>
        <sbdh:TypeVersion>1.0</sbdh:TypeVersion>
        <sbdh:InstanceIdentifier>1234567870</sbdh:InstanceIdentifier>
        <sbdh:Type>Events</sbdh:Type>
        <sbdh:CreationDateAndTime>2014-04-01T15:14:27.574-04:00</sbdh:CreationDateAndTime>
      </sbdh:DocumentIdentification>
    </sbdh:StandardBusinessDocumentHeader>
    <extension>
      <EPCISMasterData>
        <VocabularyList>
          <Vocabulary type="urn:epcglobal:epcis:vtype:EPCClass">
            <VocabularyElementList>
              <VocabularyElement id="urn:epc:class:lgtn:030000.0000002.L1">
                <attribute id="urn:epcglobal:cbv:mda:itemExpirationDate">2017-10-
31</attribute>
              </VocabularyElement>
            </VocabularyElementList>
          </Vocabulary>
        </VocabularyList>
      </EPCISMasterData>
    </extension>
  </EPCISDocument>
</pre>

```



```

        <!-- Product Master data attributes for an LSU -->
        <VocabularyElement id="urn:epc:idpat:sgtin:030000.0000002.*">
            <attribute
id="urn:epcglobal:cbv:mda#additionalTradeItemIdentification">00000000002</attribute>
            <attribute
id="urn:epcglobal:cbv:mda#additionalTradeItemIdentificationTypeCode">FDA_NDC_11</attribute>
            <attribute
id="urn:epcglobal:cbv:mda#regulatedProductName">Epcistra</attribute>
            <attribute
id="urn:epcglobal:cbv:mda#manufacturerOfTradeItemPartyName">GS1 Pharma LLC</attribute>
            <attribute id="urn:epcglobal:cbv:mda#dosageFormType">PILL</attribute>
            <attribute
id="urn:epcglobal:cbv:mda#strengthDescription">100mg</attribute>
            <attribute id="urn:epcglobal:cbv:mda#netContentDescription">480
pills</attribute>
        </VocabularyElement>
    </VocabularyElementList>
</Vocabulary>
<Vocabulary type="urn:epcglobal:epcis:vtype:Location">
    <VocabularyElementList>
        <VocabularyElement id="urn:epc:id:sgln:030000.000000.0">
            <attribute id="urn:epcglobal:cbv:mda#name">GS1 Pharma LLC</attribute>
            <attribute id="urn:epcglobal:cbv:mda#streetAddressOne">1295 S George
Ave</attribute>
            <attribute id="urn:epcglobal:cbv:mda#streetAddressTwo">Room
378</attribute>
            <attribute id="urn:epcglobal:cbv:mda#city">Washington</attribute>
            <attribute id="urn:epcglobal:cbv:mda#state">DC</attribute>
            <attribute id="urn:epcglobal:cbv:mda#postalCode">12345-
6789</attribute>
            <attribute id="urn:epcglobal:cbv:mda#countryCode">US</attribute>
        </VocabularyElement>
        <VocabularyElement id="urn:epc:id:sgln:0614141.00000.0">
            <attribute id="urn:epcglobal:cbv:mda#name">GS1 Drug Distro
LLC</attribute>
            <attribute id="urn:epcglobal:cbv:mda#streetAddressOne">230 Park Ave
S</attribute>
            <attribute id="urn:epcglobal:cbv:mda#city">New York</attribute>
            <attribute id="urn:epcglobal:cbv:mda#state">NY</attribute>
            <attribute id="urn:epcglobal:cbv:mda#postalCode">10003-
1502</attribute>
            <attribute id="urn:epcglobal:cbv:mda#countryCode">US</attribute>
        </VocabularyElement>
    </VocabularyElementList>
</Vocabulary>
</VocabularyList>
</EPCISMasterData>
</extension>
<gslushc:dscsaTransactionStatement>
    <gslushc:affirmTransactionStatement>true</gslushc:affirmTransactionStatement>
    <gslushc:legalNotice>Seller has complied with each applicable subsection of FDCA Sec.
581 (27) (A) - (G).</gslushc:legalNotice>
</gslushc:dscsaTransactionStatement>
</EPCISHeader>
<EPCISBody>
    <EventList>
        <!-- Transaction Information (TI) -->
        <ObjectEvent>
            <eventTime>2014-04-01T10:11:12Z</eventTime>
            <eventTimeZoneOffset>-05:00</eventTimeZoneOffset>
            <epcList/>

```



```

<action>OBSERVE</action>
<bizStep>urn:epcglobal:cbv:bizstep:shipping</bizStep>
<disposition>urn:epcglobal:cbv:disp:in_transit</disposition>
<readPoint>
  <id>urn:epc:id:sgln:030000.000000.0</id>
</readPoint>
<extension>
  <quantityList>
    <!-- In this example, the EPCIS quantityElement data structure contains the
lgtin for the lowest saleable unit (LSU) and the quantity value is given in terms of LSUs. For
this example scenario, each ordered case contains 12 LSUs. Hence, the quantity value will be
computed by multiplying the order case quantity with 12 LSUs. -->
    <quantityElement>
      <!-- Seller ships 1 case of 12 LSUs -->
      <epcClass>urn:epc:class:lgtin:030000.0000002.L1</epcClass>
      <quantity>12</quantity>
    </quantityElement>
  </quantityList>
  <sourceList>
    <source
type="urn:epcglobal:cbv:sdt:owning_party">urn:epc:id:sgln:030000.000000.0</source>
  </sourceList>
  <destinationList>
    <destination
type="urn:epcglobal:cbv:sdt:owning_party">urn:epc:id:sgln:0614141.00000.0</destination>
  </destinationList>
</extension>
</ObjectEvent>
</EventList>
</EPCISBody>
</epcis:EPCISDocument>

```

### 12.4.2.2 Sample XML: Buyer Receives Product



**Note:** The message content of *Buyer Receives Product* in this example is identical to the content of the *Buyer Receives Product* in the [Concealed Overage \(Keep the Extra Item\)](#) example.

Reference File: <https://resources.gs1us.org/Portals/0/xml/LotException-ConcealedOverageReturn-BuyerReceives.xml>

```

<?xml version="1.0" encoding="UTF-8"?>
<!-- Lot Exception: Concealed Overage (Return) - Buyer Receives Product -->
<!--Without opening the case, Buyer receives 1 case of 12 lowest saleable units (LSUs). -->
<!-- Note: This Receiving transaction in this example is identical to the content for
Concealed Overage (KeepExtra): Buyer Receives Product (First Receipt) -->
<epcis:EPCISDocument xmlns:cbvmda="urn:epcglobal:cbv:mda"
xmlns:sbdh="http://www.unece.org/cefact/namespaces/StandardBusinessDocumentHeader"
xmlns:gslushc="http://epcis.gslus.org/hc/ns" xmlns:epcis="urn:epcglobal:epcis:xsd:1"
schemaVersion="1.2" xsi:schemaLocation="urn:epcglobal:epcis:xsd:1 EPCglobal-epcis-1_2.xsd"
xmlns:xsi="http://www.w3.org/2001/XMLSchema-instance" creationDate="2014-04-02T15:14:27.574-
04:00">
  <EPCISHeader>
    <sbdh:StandardBusinessDocumentHeader>
      <sbdh:HeaderVersion>1.0</sbdh:HeaderVersion>
      <sbdh:Sender>
        <sbdh:Identifier
Authority="SGLN">urn:epc:id:sgln:0614141.00000.0</sbdh:Identifier>

```

```

</sbdh:Sender>
<sbdh:Receiver>
  <sbdh:Identifier
Authority="SGLN">urn:epc:id:sgln:0614141.11111.0</sbdh:Identifier>
</sbdh:Receiver>
<sbdh:DocumentIdentification>
  <sbdh:Standard>EPCglobal</sbdh:Standard>
  <sbdh:TypeVersion>1.0</sbdh:TypeVersion>
  <sbdh:InstanceIdentifier>1234567871</sbdh:InstanceIdentifier>
  <sbdh:Type>Events</sbdh:Type>
  <sbdh:CreationDateAndTime>2014-04-02T15:14:27.574-04:00</sbdh:CreationDateAndTime>
</sbdh:DocumentIdentification>
</sbdh:StandardBusinessDocumentHeader>
<extension>
  <EPCISMasterData>
    <VocabularyList>
      <Vocabulary type="urn:epcglobal:epcis:vtype:EPCClass">
        <VocabularyElementList>
          <VocabularyElement id="urn:epc:class:lgtn:030000.0000002.L1">
            <attribute id="urn:epcglobal:cbv:mda#itemExpirationDate">2017-10-
31</attribute>
          </VocabularyElement>
          <!-- Product Master data attributes for an LSU -->
          <VocabularyElement id="urn:epc:idpat:sgtin:030000.0000002.*">
            <attribute
id="urn:epcglobal:cbv:mda#additionalTradeItemIdentification">0000000002</attribute>
            <attribute
id="urn:epcglobal:cbv:mda#additionalTradeItemIdentificationTypeCode">FDA_NDC_11</attribute>
            <attribute
id="urn:epcglobal:cbv:mda#regulatedProductName">Epcistra</attribute>
            <attribute
id="urn:epcglobal:cbv:mda#manufacturerOfTradeItemPartyName">GS1 Pharma LLC</attribute>
            <attribute id="urn:epcglobal:cbv:mda#dosageFormType">PILL</attribute>
            <attribute
id="urn:epcglobal:cbv:mda#strengthDescription">100mg</attribute>
            <attribute id="urn:epcglobal:cbv:mda#netContentDescription">480
pills</attribute>
          </VocabularyElement>
        </VocabularyElementList>
      </Vocabulary>
      <Vocabulary type="urn:epcglobal:epcis:vtype:Location">
        <VocabularyElementList>
          <VocabularyElement id="urn:epc:id:sgln:030000.000000.0">
            <attribute id="urn:epcglobal:cbv:mda#name">GS1 Pharma LLC</attribute>
            <attribute id="urn:epcglobal:cbv:mda#streetAddressOne">1295 S George
Ave</attribute>
            <attribute id="urn:epcglobal:cbv:mda#streetAddressTwo">Room
378</attribute>
            <attribute id="urn:epcglobal:cbv:mda#city">Washington</attribute>
            <attribute id="urn:epcglobal:cbv:mda#state">DC</attribute>
            <attribute id="urn:epcglobal:cbv:mda#postalCode">12345-
6789</attribute>
            <attribute id="urn:epcglobal:cbv:mda#countryCode">US</attribute>
          </VocabularyElement>
        </VocabularyElementList>
      <VocabularyElement id="urn:epc:id:sgln:0614141.00000.0">
        <attribute id="urn:epcglobal:cbv:mda#name">GS1 Drug Distro
LLC</attribute>
        <attribute id="urn:epcglobal:cbv:mda#streetAddressOne">230 Park Ave
S</attribute>
        <attribute id="urn:epcglobal:cbv:mda#city">New York</attribute>
        <attribute id="urn:epcglobal:cbv:mda#state">NY</attribute>

```

```

        <attribute id="urn:epcglobal:cbv:mda#postalCode">10003-
1502</attribute>
        <attribute id="urn:epcglobal:cbv:mda#countryCode">US</attribute>
    </VocabularyElement>
</VocabularyElementList>
</Vocabulary>
</VocabularyList>
</EPCISMasterData>
</extension>
</EPCISHeader>
<EPCISBody>
    <EventList>
        <ObjectEvent>
            <eventTime>2014-04-02T10:11:12Z</eventTime>
            <eventTimeZoneOffset>-05:00</eventTimeZoneOffset>
            <epcList/>
            <action>OBSERVE</action>
            <bizStep>urn:epcglobal:cbv:bizstep:receiving</bizStep>
            <disposition>urn:epcglobal:cbv:disp:in_progress</disposition>
            <readPoint>
                <id>urn:epc:id:sgln:0614141.00000.0</id>
            </readPoint>
            <extension>
                <quantityList>
                    <!-- In this example, the EPCIS quantityElement data structure contains the
lgtin for the lowest saleable unit (LSU) and the quantity value is given in terms of LSUs. For
this example scenario, each ordered case contains 12 LSUs. Hence, the quantity value will be
computed by multiplying the order case quantity with 12 LSUs. -->
                    <quantityElement>
                        <!-- Buyer receives 1 case of 12 LSUs into inventory -->
                        <epcClass>urn:epc:class:lgtin:030000.0000002.L1</epcClass>
                        <quantity>12</quantity>
                    </quantityElement>
                </quantityList>
                <sourceList>
                    <source
type="urn:epcglobal:cbv:sdt:owning_party">urn:epc:id:sgln:030000.000000.0</source>
                </sourceList>
                <destinationList>
                    <destination
type="urn:epcglobal:cbv:sdt:owning_party">urn:epc:id:sgln:0614141.00000.0</destination>
                </destinationList>
            </extension>
        </ObjectEvent>
    </EventList>
</EPCISBody>
</epcis:EPCISDocument>

```

## 12.5 Concealed Shortage

### 12.5.1 Have Current Order Fulfilled

#### 12.5.1.1 Sample XML: Exchange1 - Seller → Buyer

Reference File: <https://resources.gs1us.org/Portals/0/xml/LotException-ConcealedShortageFulfill-SellerExchange1.xml>

```
<?xml version="1.0" encoding="UTF-8"?>
<!-- Lot Exception: Concealed Shortage (Fulfill) - Exchange1: Seller -> Buyer-->
<!-- Buyer orders 1 case of 12 lowest saleable units (LSUs). The seller ships 1 case to the
buyer. Seller's IT system reflects there are 12 LSUs in the case.
In reality, there are 11 LSUs that got shipped in the 1 case. -->
<epcis:EPCISDocument xmlns:cbvmda="urn:epcglobal:cbv:mda"
xmlns:sbdh="http://www.unece.org/cefact/namespaces/StandardBusinessDocumentHeader"
xmlns:gslushc="http://epcis.gslus.org/hc/ns" xmlns:epcis="urn:epcglobal:epcis:xsd:1"
schemaVersion="1.2" xsi:schemaLocation="urn:epcglobal:epcis:xsd:1 EPCglobal-epcis-1_2.xsd"
xmlns:xsi="http://www.w3.org/2001/XMLSchema-instance" creationDate="2014-04-01T15:14:27.574-
04:00">
  <EPCISHeader>
    <sbdh:StandardBusinessDocumentHeader>
      <sbdh:HeaderVersion>1.0</sbdh:HeaderVersion>
      <sbdh:Sender>
        <sbdh:Identifier
Authority="SGLN">urn:epc:id:sgln:030000.000000.0</sbdh:Identifier>
        </sbdh:Sender>
        <sbdh:Receiver>
          <sbdh:Identifier
Authority="SGLN">urn:epc:id:sgln:0614141.000000.0</sbdh:Identifier>
          </sbdh:Receiver>
        <sbdh:DocumentIdentification>
          <sbdh:Standard>EPCglobal</sbdh:Standard>
          <sbdh:TypeVersion>1.0</sbdh:TypeVersion>
          <sbdh:InstanceIdentifier>1234567874</sbdh:InstanceIdentifier>
          <sbdh:Type>Events</sbdh:Type>
          <sbdh:CreationDateAndTime>2014-04-01T15:14:27.574-04:00</sbdh:CreationDateAndTime>
        </sbdh:DocumentIdentification>
      </sbdh:StandardBusinessDocumentHeader>
      <extension>
        <EPCISMasterData>
          <VocabularyList>
            <Vocabulary type="urn:epcglobal:epcis:vtype:EPCClass">
              <VocabularyElementList>
                <VocabularyElement id="urn:epc:class:lgtin:030000.0000002.L1">
                  <attribute id="urn:epcglobal:cbv:mda#itemExpirationDate">2017-10-
31</attribute>
                </VocabularyElement>
                <!-- Product Master data attributes for a lowest saleable unit (LSU) -->
                <VocabularyElement id="urn:epc:idpat:sgtin:030000.0000002.*">
                  <attribute
id="urn:epcglobal:cbv:mda#additionalTradeItemIdentification">0000000002</attribute>
                  <attribute
id="urn:epcglobal:cbv:mda#additionalTradeItemIdentificationTypeCode">FDA_NDC_11</attribute>
                  <attribute
id="urn:epcglobal:cbv:mda#regulatedProductName">Epcistra</attribute>
                  <attribute
id="urn:epcglobal:cbv:mda#manufacturerOfTradeItemPartyName">GS1 Pharma LLC</attribute>
                  <attribute id="urn:epcglobal:cbv:mda#dosageFormType">PILL</attribute>
                </VocabularyElement>
              </VocabularyElementList>
            </Vocabulary>
          </VocabularyList>
        </EPCISMasterData>
      </extension>
    </EPCISHeader>
  </EPCISDocument>

```

```

        <attribute
id="urn:epcglobal:cbv:mda#strengthDescription">100mg</attribute>
        <attribute id="urn:epcglobal:cbv:mda#netContentDescription">480
pills</attribute>
    </VocabularyElement>
</VocabularyElementList>
</Vocabulary>
<Vocabulary type="urn:epcglobal:epcis:vtype:Location">
    <VocabularyElementList>
        <VocabularyElement id="urn:epc:id:sgln:030000.000000.0">
            <attribute id="urn:epcglobal:cbv:mda#name">GS1 Pharma LLC</attribute>
            <attribute id="urn:epcglobal:cbv:mda#streetAddressOne">1295 S George
Ave</attribute>
            <attribute id="urn:epcglobal:cbv:mda#streetAddressTwo">Room
378</attribute>
            <attribute id="urn:epcglobal:cbv:mda#city">Washington</attribute>
            <attribute id="urn:epcglobal:cbv:mda#state">DC</attribute>
            <attribute id="urn:epcglobal:cbv:mda#postalCode">12345-
6789</attribute>
            <attribute id="urn:epcglobal:cbv:mda#countryCode">US</attribute>
        </VocabularyElement>
        <VocabularyElement id="urn:epc:id:sgln:0614141.000000.0">
            <attribute id="urn:epcglobal:cbv:mda#name">GS1 Drug Distro
LLC</attribute>
            <attribute id="urn:epcglobal:cbv:mda#streetAddressOne">230 Park Ave
S</attribute>
            <attribute id="urn:epcglobal:cbv:mda#city">New York</attribute>
            <attribute id="urn:epcglobal:cbv:mda#state">NY</attribute>
            <attribute id="urn:epcglobal:cbv:mda#postalCode">10003-
1502</attribute>
            <attribute id="urn:epcglobal:cbv:mda#countryCode">US</attribute>
        </VocabularyElement>
    </VocabularyElementList>
</Vocabulary>
</VocabularyList>
</EPCISMasterData>
</extension>
<gslushc:dscsaTransactionStatement>
    <gslushc:affirmTransactionStatement>true</gslushc:affirmTransactionStatement>
    <gslushc:legalNotice>Seller has complied with each applicable subsection of FDCA Sec.
581 (27) (A) - (G).</gslushc:legalNotice>
</gslushc:dscsaTransactionStatement>
</EPCISHeader>
<EPCISBody>
    <EventList>
        <!-- Transaction Information (TI) -->
        <ObjectEvent>
            <eventTime>2014-04-01T10:11:12Z</eventTime>
            <eventTimeZoneOffset>-05:00</eventTimeZoneOffset>
            <epcList/>
            <action>OBSERVE</action>
            <bizStep>urn:epcglobal:cbv:bizstep:shipping</bizStep>
            <disposition>urn:epcglobal:cbv:disp:in_transit</disposition>
            <readPoint>
                <id>urn:epc:id:sgln:030000.000000.0</id>
            </readPoint>
            <extension>
                <quantityList>
                    <!-- In this example, the EPCIS quantityElement data structure contains the
lgtin for the lowest saleable unit (LSU) and the quantity value is given in terms of LSUs. For

```

this example scenario, each ordered case contains 12 LSUs. Hence, the quantity value will be computed by multiplying the order case quantity with 12 LSUs. -->

```

    <quantityElement>
      <!-- Seller ships 1 case of 12 LSUs -->
      <epcClass>urn:epc:class:lgtin:030000.0000002.L1</epcClass>
      <quantity>12</quantity>
    </quantityElement>
  </quantityList>
  <sourceList>
    <source
type="urn:epcglobal:cbv:sdt:owning_party">urn:epc:id:sgln:030000.000000.0</source>
    </sourceList>
  <destinationList>
    <destination
type="urn:epcglobal:cbv:sdt:owning_party">urn:epc:id:sgln:0614141.00000.0</destination>
    </destinationList>
  </extension>
</ObjectEvent>
</EventList>
</EPCISBody>
</epcis:EPCISDocument>

```

### 12.5.1.2 Sample XML: Buyer Receives Product (1st Receipt)

Reference File: <https://resources.gs1us.org/Portals/0/xml/LotException-ConcealedShortageFulfill-BuyerReceives-1st.xml>

```

<?xml version="1.0" encoding="UTF-8"?>
<!-- Lot Exception: Concealed Shortage (Fulfill) - Buyer Receives Product (First Receipt) -->
<!-- After opening the case, buyer discovers 1 missing LSU and receives the 11 lowest saleable
units (LSUs) found in the case. -->
<epcis:EPCISDocument xmlns:cbvmda="urn:epcglobal:cbv:mda"
xmlns:sbdh="http://www.unece.org/cefact/namespaces/StandardBusinessDocumentHeader"
xmlns:gslushc="http://epcis.gs1us.org/hc/ns" xmlns:epcis="urn:epcglobal:epcis:xsd:1"
schemaVersion="1.2" xsi:schemaLocation="urn:epcglobal:epcis:xsd:1 EPCglobal-epcis-1_2.xsd"
xmlns:xsi="http://www.w3.org/2001/XMLSchema-instance" creationDate="2014-04-02T15:14:27.574-
04:00">
  <EPCISHeader>
    <sbdh:StandardBusinessDocumentHeader>
      <sbdh:HeaderVersion>1.0</sbdh:HeaderVersion>
      <sbdh:Sender>
        <sbdh:Identifier
Authority="SGLN">urn:epc:id:sgln:0614141.00000.0</sbdh:Identifier>
      </sbdh:Sender>
      <sbdh:Receiver>
        <sbdh:Identifier
Authority="SGLN">urn:epc:id:sgln:0614141.11111.0</sbdh:Identifier>
      </sbdh:Receiver>
      <sbdh:DocumentIdentification>
        <sbdh:Standard>EPCglobal</sbdh:Standard>
        <sbdh:TypeVersion>1.0</sbdh:TypeVersion>
        <sbdh:InstanceIdentifier>1234567875</sbdh:InstanceIdentifier>
        <sbdh:Type>Events</sbdh:Type>
        <sbdh:CreationDateAndTime>2014-04-02T15:14:27.574-04:00</sbdh:CreationDateAndTime>
      </sbdh:DocumentIdentification>
    </sbdh:StandardBusinessDocumentHeader>
  <extension>
    <EPCISMasterData>
      <VocabularyList>
        <Vocabulary type="urn:epcglobal:epcis:vtype:EPCClass">

```

```

    <VocabularyElementList>
      <VocabularyElement id="urn:epc:class:lgtin:030000.0000002.L1">
        <attribute id="urn:epcglobal:cbv:mda#itemExpirationDate">2017-10-
31</attribute>
        </VocabularyElement>
        <!-- Product Master data attributes for a lowest saleable unit (LSU) -->
        <VocabularyElement id="urn:epc:idpat:sgtin:030000.0000002.*">
          <attribute
id="urn:epcglobal:cbv:mda#additionalTradeItemIdentification">00000000002</attribute>
          <attribute
id="urn:epcglobal:cbv:mda#additionalTradeItemIdentificationTypeCode">FDA_NDC_11</attribute>
          <attribute
id="urn:epcglobal:cbv:mda#regulatedProductName">Epcistra</attribute>
          <attribute
id="urn:epcglobal:cbv:mda#manufacturerOfTradeItemPartyName">GS1 Pharma LLC</attribute>
          <attribute id="urn:epcglobal:cbv:mda#dosageFormType">PILL</attribute>
          <attribute
id="urn:epcglobal:cbv:mda#strengthDescription">100mg</attribute>
          <attribute id="urn:epcglobal:cbv:mda#netContentDescription">480
pills</attribute>
        </VocabularyElement>
      </VocabularyElementList>
    </Vocabulary>
    <Vocabulary type="urn:epcglobal:epcis:vtype:Location">
      <VocabularyElementList>
        <VocabularyElement id="urn:epc:id:sgln:030000.000000.0">
          <attribute id="urn:epcglobal:cbv:mda#name">GS1 Pharma LLC</attribute>
          <attribute id="urn:epcglobal:cbv:mda#streetAddressOne">1295 S George
Ave</attribute>
          <attribute id="urn:epcglobal:cbv:mda#streetAddressTwo">Room
378</attribute>
          <attribute id="urn:epcglobal:cbv:mda#city">Washington</attribute>
          <attribute id="urn:epcglobal:cbv:mda#state">DC</attribute>
          <attribute id="urn:epcglobal:cbv:mda#postalCode">12345-
6789</attribute>
          <attribute id="urn:epcglobal:cbv:mda#countryCode">US</attribute>
        </VocabularyElement>
        <VocabularyElement id="urn:epc:id:sgln:0614141.00000.0">
          <attribute id="urn:epcglobal:cbv:mda#name">GS1 Drug Distro
LLC</attribute>
          <attribute id="urn:epcglobal:cbv:mda#streetAddressOne">230 Park Ave
S</attribute>
          <attribute id="urn:epcglobal:cbv:mda#city">New York</attribute>
          <attribute id="urn:epcglobal:cbv:mda#state">NY</attribute>
          <attribute id="urn:epcglobal:cbv:mda#postalCode">10003-
1502</attribute>
          <attribute id="urn:epcglobal:cbv:mda#countryCode">US</attribute>
        </VocabularyElement>
      </VocabularyElementList>
    </Vocabulary>
  </VocabularyList>
</EPCISMasterData>
</extension>
</EPCISHeader>
<EPCISBody>
  <EventList>
    <ObjectEvent>
      <eventTime>2014-04-02T10:11:12Z</eventTime>
      <eventTimeZoneOffset>-05:00</eventTimeZoneOffset>
      <epcList/>
      <action>OBSERVE</action>

```



```

<bizStep>urn:epcglobal:cbv:bizstep:receiving</bizStep>
<disposition>urn:epcglobal:cbv:disp:in_progress</disposition>
<readPoint>
  <id>urn:epc:id:sgln:0614141.00000.0</id>
</readPoint>
<extension>
  <quantityList>
    <!-- In this example, the EPCIS quantityElement data structure contains the
lgtin for the lowest saleable unit (LSU) and the quantity value is given in terms of LSUs. -->
    <quantityElement>
      <!-- Buyer receives 11 LSUs into inventory -->
      <epcClass>urn:epc:class:lgtin:030000.0000002.L1</epcClass>
      <quantity>11</quantity>
    </quantityElement>
  </quantityList>
  <sourceList>
    <source
type="urn:epcglobal:cbv:sdt:owning_party">urn:epc:id:sgln:030000.000000.0</source>
  </sourceList>
  <destinationList>
    <destination
type="urn:epcglobal:cbv:sdt:owning_party">urn:epc:id:sgln:0614141.00000.0</destination>
  </destinationList>
</extension>
</ObjectEvent>
</EventList>
</EPCISBody>
</epcis:EPCISDocument>

```

### 12.5.1.3 Sample XML: Seller Corrects Shipment Data

Reference File: <https://resources.gs1us.org/Portals/0/xml/LotException-ConcealedShortageFulfill-SellerCorrectsShipmentData.xml>

```

<?xml version="1.0" encoding="UTF-8"?>
<!-- Lot Exception: Concealed Shortage (Fulfill) - Seller corrects shipment data -->
<!-- After getting notified that only 11 lowest saleable units (LSUs) were found in the case,
seller investigates the discrepancy and resolves issue by generating voidShipping Event for the
1 missing LSU -->
<epcis:EPCISDocument xmlns:cbvmda="urn:epcglobal:cbv:mda"
xmlns:sbdh="http://www.unece.org/cefact/namespaces/StandardBusinessDocumentHeader"
xmlns:gslushc="http://epcis.gslus.org/hc/ns" xmlns:epcis="urn:epcglobal:epcis:xsd:1"
schemaVersion="1.2" xsi:schemaLocation="urn:epcglobal:epcis:xsd:1 EPCglobal-epcis-1_2.xsd"
xmlns:xsi="http://www.w3.org/2001/XMLSchema-instance" creationDate="2014-04-03T15:14:27.574-
04:00">
  <EPCISHeader>
    <sbdh:StandardBusinessDocumentHeader>
      <sbdh:HeaderVersion>1.0</sbdh:HeaderVersion>
      <sbdh:Sender>
        <sbdh:Identifier
Authority="SGLN">urn:epc:id:sgln:030000.000000.0</sbdh:Identifier>
      </sbdh:Sender>
      <sbdh:Receiver>
        <sbdh:Identifier
Authority="SGLN">urn:epc:id:sgln:030000.000001.0</sbdh:Identifier>
      </sbdh:Receiver>
      <sbdh:DocumentIdentification>
        <sbdh:Standard>EPCglobal</sbdh:Standard>
        <sbdh:TypeVersion>1.0</sbdh:TypeVersion>
        <sbdh:InstanceIdentifier>1234567876</sbdh:InstanceIdentifier>

```



```

        <sbdh:Type>Events</sbdh:Type>
        <sbdh:CreationDateAndTime>2014-04-03T15:14:27.574-04:00</sbdh:CreationDateAndTime>
    </sbdh:DocumentIdentification>
</sbdh:StandardBusinessDocumentHeader>
<extension>
    <EPCISMasterData>
        <VocabularyList>
            <Vocabulary type="urn:epcglobal:epcis:vtype:EPCClass">
                <VocabularyElementList>
                    <VocabularyElement id="urn:epc:class:lgtin:030000.0000002.L1">
                        <attribute id="urn:epcglobal:cbv:mda#itemExpirationDate">2017-10-
31</attribute>
                    </VocabularyElement>
                    <!-- Product Master data attributes for a lowest saleable unit (LSU) -->
                    <VocabularyElement id="urn:epc:idpat:sgtin:030000.0000002.*">
                        <attribute
id="urn:epcglobal:cbv:mda#additionalTradeItemIdentification">0000000002</attribute>
                        <attribute
id="urn:epcglobal:cbv:mda#additionalTradeItemIdentificationTypeCode">FDA_NDC_11</attribute>
                        <attribute
id="urn:epcglobal:cbv:mda#regulatedProductName">Epcistra</attribute>
                        <attribute
id="urn:epcglobal:cbv:mda#manufacturerOfTradeItemPartyName">GS1 Pharma LLC</attribute>
                        <attribute id="urn:epcglobal:cbv:mda#dosageFormType">PILL</attribute>
                        <attribute
id="urn:epcglobal:cbv:mda#strengthDescription">100mg</attribute>
                        <attribute id="urn:epcglobal:cbv:mda#netContentDescription">40
pills</attribute>
                    </VocabularyElement>
                </VocabularyElementList>
            </Vocabulary>
            <Vocabulary type="urn:epcglobal:epcis:vtype:Location">
                <VocabularyElementList>
                    <VocabularyElement id="urn:epc:id:sgln:030000.000000.0">
                        <attribute id="urn:epcglobal:cbv:mda#name">GS1 Pharma LLC</attribute>
                        <attribute id="urn:epcglobal:cbv:mda#streetAddressOne">1295 S George
Ave</attribute>
                        <attribute id="urn:epcglobal:cbv:mda#streetAddressTwo">Room
378</attribute>
                        <attribute id="urn:epcglobal:cbv:mda#city">Washington</attribute>
                        <attribute id="urn:epcglobal:cbv:mda#state">DC</attribute>
                        <attribute id="urn:epcglobal:cbv:mda#postalCode">12345-
6789</attribute>
                        <attribute id="urn:epcglobal:cbv:mda#countryCode">US</attribute>
                    </VocabularyElement>
                    <VocabularyElement id="urn:epc:id:sgln:0614141.00000.0">
                        <attribute id="urn:epcglobal:cbv:mda#name">GS1 Drug Distro
LLC</attribute>
                        <attribute id="urn:epcglobal:cbv:mda#streetAddressOne">230 Park Ave
S</attribute>
                        <attribute id="urn:epcglobal:cbv:mda#city">New York</attribute>
                        <attribute id="urn:epcglobal:cbv:mda#state">NY</attribute>
                        <attribute id="urn:epcglobal:cbv:mda#postalCode">10003-
1502</attribute>
                        <attribute id="urn:epcglobal:cbv:mda#countryCode">US</attribute>
                    </VocabularyElement>
                </VocabularyElementList>
            </Vocabulary>
        </VocabularyList>
    </EPCISMasterData>

```

```

    </extension>
  </EPCISHeader>
  <EPCISBody>
    <EventList>
      <ObjectEvent>
        <eventTime>2014-04-03T10:11:12Z</eventTime>
        <eventTimeZoneOffset>-05:00</eventTimeZoneOffset>
        <epcList/>
        <action>OBSERVE</action>
        <bizStep>urn:epcglobal:cbv:bizstep:void_shipping</bizStep>
        <disposition>urn:epcglobal:cbv:disp:in_progress</disposition>
        <readPoint>
          <id>urn:epc:id:sgln:030000.000000.0</id>
        </readPoint>
        <extension>
          <quantityList>
            <!-- In this example, the EPCIS quantityElement data structure contains the
lgtin for the lowest saleable unit (LSU) and the quantity value is given in terms of LSUs. -->
            <quantityElement>
              <!-- Voiding the shipment of 1 LSU that was not included in the shipment
-->
              <epcClass>urn:epc:class:lgtin:030000.0000002.L1</epcClass>
              <quantity>1</quantity>
            </quantityElement>
          </quantityList>
          <sourceList>
            <source
type="urn:epcglobal:cbv:sdt:owning_party">urn:epc:id:sgln:030000.000000.0</source>
          </sourceList>
          <destinationList>
            <destination
type="urn:epcglobal:cbv:sdt:owning_party">urn:epc:id:sgln:0614141.00000.0</destination>
          </destinationList>
        </extension>
      </ObjectEvent>
    </EventList>
  </EPCISBody>
</epcis:EPCISDocument>

```

#### 12.5.1.4 Sample XML: Exchange2 - Seller → Buyer

Reference File: <https://resources.gs1us.org/Portals/0/xml/LotException-ConcealedShortageFulfill-SellerExchange2.xml>

```

<?xml version="1.0" encoding="UTF-8"?>
<!-- Lot Exception Concealed Shortage (Fulfill) - Exchange2: Seller -> Buyer -->
<!-- Since the buyer wants the seller to fulfill the order of 12 lowest saleable units (LSUs)
in a case, the seller physically ships 1 LSU to fulfill order and generates Shipping event for
1 LSU -->
<epcis:EPCISDocument xmlns:cbvmda="urn:epcglobal:cbv:mda"
xmlns:sbdh="http://www.unece.org/cefact/namespaces/StandardBusinessDocumentHeader"
xmlns:gslushc="http://epcis.gs1us.org/hc/ns" xmlns:epcis="urn:epcglobal:epcis:xsd:1"
schemaVersion="1.2" xsi:schemaLocation="urn:epcglobal:epcis:xsd:1 EPCglobal-epcis-1_2.xsd"
xmlns:xsi="http://www.w3.org/2001/XMLSchema-instance" creationDate="2014-04-04T15:14:27.574-
04:00">
  <EPCISHeader>
    <sbdh:StandardBusinessDocumentHeader>
      <sbdh:HeaderVersion>1.0</sbdh:HeaderVersion>
      <sbdh:Sender>

```

```

        <sbdh:Identifier
Authority="SGLN">urn:epc:id:sgln:030000.000000.0</sbdh:Identifier>
        </sbdh:Sender>
        <sbdh:Receiver
        <sbdh:Identifier
Authority="SGLN">urn:epc:id:sgln:0614141.000000.0</sbdh:Identifier>
        </sbdh:Receiver>
        <sbdh:DocumentIdentification>
        <sbdh:Standard>EPCglobal</sbdh:Standard>
        <sbdh:TypeVersion>1.0</sbdh:TypeVersion>
        <sbdh:InstanceIdentifier>1234567877</sbdh:InstanceIdentifier>
        <sbdh:Type>Events</sbdh:Type>
        <sbdh:CreationDateAndTime>2014-04-04T15:14:27.574-04:00</sbdh:CreationDateAndTime>
        </sbdh:DocumentIdentification>
    </sbdh:StandardBusinessDocumentHeader>
    <extension>
        <EPCISMasterData>
            <VocabularyList>
                <Vocabulary type="urn:epcglobal:epcis:vtype:EPCClass">
                    <!-- GTIN B -->
                    <VocabularyElementList>
                        <VocabularyElement id="urn:epc:class:lgtn:030000.0000002.L4">
                            <attribute id="urn:epcglobal:cbv:mda#itemExpirationDate">2017-10-
31</attribute>
                            </VocabularyElement>
                            <!-- Product Master data attributes for a lowest saleable unit (LSU) --
>
                            <VocabularyElement id="urn:epc:idpat:sgtin:030000.0000002.*">
                                <attribute
id="urn:epcglobal:cbv:mda#additionalTradeItemIdentification">0000000002</attribute>
                                <attribute
id="urn:epcglobal:cbv:mda#additionalTradeItemIdentificationTypeCode">FDA_NDC_11</attribute>
                                <attribute
id="urn:epcglobal:cbv:mda#regulatedProductName">Epcistra</attribute>
                                <attribute
id="urn:epcglobal:cbv:mda#manufacturerOfTradeItemPartyName">GS1 Pharma LLC</attribute>
                                <attribute id="urn:epcglobal:cbv:mda#dosageFormType">PILL</attribute>
                                <attribute
id="urn:epcglobal:cbv:mda#strengthDescription">100mg</attribute>
                                <attribute id="urn:epcglobal:cbv:mda#netContentDescription">40
pills</attribute>
                                </VocabularyElement>
                            </VocabularyElementList>
                        </Vocabulary>
                        <Vocabulary type="urn:epcglobal:epcis:vtype:Location">
                            <VocabularyElementList>
                                <VocabularyElement id="urn:epc:id:sgln:030000.000000.0">
                                    <attribute id="urn:epcglobal:cbv:mda#name">GS1 Pharma LLC</attribute>
                                    <attribute id="urn:epcglobal:cbv:mda#streetAddressOne">1295 S George
Ave</attribute>
                                    <attribute id="urn:epcglobal:cbv:mda#streetAddressTwo">Room
378</attribute>
                                    <attribute id="urn:epcglobal:cbv:mda#city">Washington</attribute>
                                    <attribute id="urn:epcglobal:cbv:mda#state">DC</attribute>
                                    <attribute id="urn:epcglobal:cbv:mda#postalCode">12345-
6789</attribute>
                                    <attribute id="urn:epcglobal:cbv:mda#countryCode">US</attribute>
                                </VocabularyElement>
                                <VocabularyElement id="urn:epc:id:sgln:0614141.000000.0">
                                    <attribute id="urn:epcglobal:cbv:mda#name">GS1 Drug Distro
LLC</attribute>

```

```

        <attribute id="urn:epcglobal:cbv:mda#streetAddressOne">230 Park Ave
S</attribute>
        <attribute id="urn:epcglobal:cbv:mda#city">New York</attribute>
        <attribute id="urn:epcglobal:cbv:mda#state">NY</attribute>
        <attribute id="urn:epcglobal:cbv:mda#postalCode">10003-
1502</attribute>
        <attribute id="urn:epcglobal:cbv:mda#countryCode">US</attribute>
        </VocabularyElement>
    </VocabularyElementList>
</Vocabulary>
</VocabularyList>
</EPCISMasterData>
</extension>
<gslushc:dscsaTransactionStatement>
    <gslushc:affirmTransactionStatement>true</gslushc:affirmTransactionStatement>
    <gslushc:legalNotice>Seller has complied with each applicable subsection of FDCA Sec.
581 (27) (A)–(G).</gslushc:legalNotice>
</gslushc:dscsaTransactionStatement>
</EPCISHeader>
<EPCISBody>
    <EventList>
        <!-- Transaction Information (TI) -->
        <ObjectEvent>
            <eventTime>2014-04-04T10:11:12Z</eventTime>
            <eventTimeZoneOffset>-05:00</eventTimeZoneOffset>
            <epcList/>
            <action>OBSERVE</action>
            <bizStep>urn:epcglobal:cbv:bizstep:shipping</bizStep>
            <disposition>urn:epcglobal:cbv:disp:in_transit</disposition>
            <readPoint>
                <id>urn:epc:id:sgln:030000.000000.0</id>
            </readPoint>
            <extension>
                <quantityList>
                    <!-- In this example, the EPCIS quantityElement data structure contains the
lgtin for the lowest saleable unit (LSU) and the quantity value is given in terms of LSUs. -->
                    <quantityElement>
                        <!-- Seller generates shipping event for 1 lowest saleable unit to
account for the 1 item shortage -->
                        <epcClass>urn:epc:class:lgtin:030000.0000002.L4</epcClass>
                        <quantity>1</quantity>
                    </quantityElement>
                </quantityList>
            </extension>
            <sourceList>
                <source
type="urn:epcglobal:cbv:sdt:owning_party">urn:epc:id:sgln:030000.000000.0</source>
            </sourceList>
            <destinationList>
                <destination
type="urn:epcglobal:cbv:sdt:owning_party">urn:epc:id:sgln:0614141.00000.0</destination>
            </destinationList>
        </ObjectEvent>
    </EventList>
</EPCISBody>
</epcis:EPCISDocument>

```

### 12.5.1.5 Sample XML: Buyer Receives Product (2nd Receipt)

Reference File: <https://resources.gs1us.org/Portals/0/xml/LotException-ConcealedShortageFulfill-BuyerReceives-2nd.xml>

```
<?xml version="1.0" encoding="UTF-8"?>
<!-- Lot Exception: Concealed Shortage (Fulfill)- Buyer Receives Product (2nd Receipt) -->
<!--Buyer receives 1 lowest saleable unit (LSU) of into inventory -->
<epcis:EPCISDocument xmlns:cbvmda="urn:epcglobal:cbv:mda"
xmlns:sbdh="http://www.unece.org/cefact/namespaces/StandardBusinessDocumentHeader"
xmlns:gs1ushc="http://epcis.gs1us.org/hc/ns" xmlns:epcis="urn:epcglobal:epcis:xsd:1"
schemaVersion="1.2" xsi:schemaLocation="urn:epcglobal:epcis:xsd:1 EPCglobal-epcis-1_2.xsd"
xmlns:xsi="http://www.w3.org/2001/XMLSchema-instance" creationDate="2014-04-05T15:14:27.574-
04:00">
  <EPCISHeader>
    <sbdh:StandardBusinessDocumentHeader>
      <sbdh:HeaderVersion>1.0</sbdh:HeaderVersion>
      <sbdh:Sender>
        <sbdh:Identifier
Authority="SGLN">urn:epc:id:sgln:0614141.00000.0</sbdh:Identifier>
        </sbdh:Sender>
        <sbdh:Receiver>
          <sbdh:Identifier
Authority="SGLN">urn:epc:id:sgln:0614141.11111.0</sbdh:Identifier>
          </sbdh:Receiver>
        <sbdh:DocumentIdentification>
          <sbdh:Standard>EPCglobal</sbdh:Standard>
          <sbdh:TypeVersion>1.0</sbdh:TypeVersion>
          <sbdh:InstanceIdentifier>1234567878</sbdh:InstanceIdentifier>
          <sbdh:Type>Events</sbdh:Type>
          <sbdh:CreationDateAndTime>2014-04-05T15:14:27.574-04:00</sbdh:CreationDateAndTime>
        </sbdh:DocumentIdentification>
      </sbdh:StandardBusinessDocumentHeader>
      <extension>
        <EPCISMasterData>
          <VocabularyList>
            <Vocabulary type="urn:epcglobal:epcis:vtype:EPCClass">
              <VocabularyElementList>
                <VocabularyElement id="urn:epc:class:lgtn:030000.0000002.L4">
                  <attribute id="urn:epcglobal:cbv:mda#itemExpirationDate">2017-10-
31</attribute>
                </VocabularyElement>
                <!-- Product Master data attributes for a lowest saleable unit (LSU) -->
                <VocabularyElement id="urn:epc:idpat:sgtin:030000.0000002.*">
                  <attribute
id="urn:epcglobal:cbv:mda#additionalTradeItemIdentification">0000000002</attribute>
                  <attribute
id="urn:epcglobal:cbv:mda#additionalTradeItemIdentificationTypeCode">FDA_NDC_11</attribute>
                  <attribute
id="urn:epcglobal:cbv:mda#regulatedProductName">Epcistra</attribute>
                  <attribute
id="urn:epcglobal:cbv:mda#manufacturerOfTradeItemPartyName">GS1 Pharma LLC</attribute>
                  <attribute id="urn:epcglobal:cbv:mda#dosageFormType">PILL</attribute>
                  <attribute
id="urn:epcglobal:cbv:mda#strengthDescription">100mg</attribute>
                  <attribute id="urn:epcglobal:cbv:mda#netContentDescription">40
pills</attribute>
                </VocabularyElement>
              </VocabularyElementList>
            </Vocabulary>
          </EPCISMasterData>
        </extension>
      </EPCISHeader>
    </sbdh:StandardBusinessDocumentHeader>
  </EPCISDocument>

```

```

    <Vocabulary type="urn:epcglobal:epcis:vtype:Location">
      <VocabularyElementList>
        <VocabularyElement id="urn:epc:id:sgln:030000.000000.0">
          <attribute id="urn:epcglobal:cbv:mda#name">GS1 Pharma LLC</attribute>
          <attribute id="urn:epcglobal:cbv:mda#streetAddressOne">1295 S George
Ave</attribute>
          <attribute id="urn:epcglobal:cbv:mda#streetAddressTwo">Room
378</attribute>
          <attribute id="urn:epcglobal:cbv:mda#city">Washington</attribute>
          <attribute id="urn:epcglobal:cbv:mda#state">DC</attribute>
          <attribute id="urn:epcglobal:cbv:mda#postalCode">12345-
6789</attribute>
          <attribute id="urn:epcglobal:cbv:mda#countryCode">US</attribute>
        </VocabularyElement>
        <VocabularyElement id="urn:epc:id:sgln:0614141.00000.0">
          <attribute id="urn:epcglobal:cbv:mda#name">GS1 Drug Distro
LLC</attribute>
          <attribute id="urn:epcglobal:cbv:mda#streetAddressOne">230 Park Ave
S</attribute>
          <attribute id="urn:epcglobal:cbv:mda#city">New York</attribute>
          <attribute id="urn:epcglobal:cbv:mda#state">NY</attribute>
          <attribute id="urn:epcglobal:cbv:mda#postalCode">10003-
1502</attribute>
          <attribute id="urn:epcglobal:cbv:mda#countryCode">US</attribute>
        </VocabularyElement>
      </VocabularyElementList>
    </Vocabulary>
  </VocabularyList>
</EPCISMasterData>
</extension>
</EPCISHeader>
<EPCISBody>
  <EventList>
    <ObjectEvent>
      <eventTime>2014-04-05T10:11:12Z</eventTime>
      <eventTimeZoneOffset>-05:00</eventTimeZoneOffset>
      <epcList/>
      <action>OBSERVE</action>
      <bizStep>urn:epcglobal:cbv:bizstep:receiving</bizStep>
      <disposition>urn:epcglobal:cbv:disp:in_progress</disposition>
      <readPoint>
        <id>urn:epc:id:sgln:0614141.00000.0</id>
      </readPoint>
      <extension>
        <quantityList>
          <!-- In this example, the EPCIS quantityElement data structure contains the
lgtin for the lowest saleable unit (LSU) and the quantity value is given in terms of LSUs. -->
          <quantityElement>
            <!-- Buyer receives 1 lowest saleable unit into inventory -->
            <epcClass>urn:epc:class:lgtin:030000.0000002.L4</epcClass>
            <quantity>1</quantity>
          </quantityElement>
        </quantityList>
        <sourceList>
          <source
type="urn:epcglobal:cbv:sdt:owning_party">urn:epc:id:sgln:030000.000000.0</source>
        </sourceList>
        <destinationList>
          <destination
type="urn:epcglobal:cbv:sdt:owning_party">urn:epc:id:sgln:0614141.00000.0</destination>
        </destinationList>
      </extension>
    </ObjectEvent>
  </EventList>
</EPCISBody>
</EPCIS>

```

```

        </extension>
      </ObjectEvent>
    </EventList>
  </EPCISBody>
</epcis:EPCISDocument>

```

## 12.5.2 Accept Items Physically Received – Cancel Missing Item

### 12.5.2.1 Sample XML: Exchange1 - Seller → Buyer



**Note:** The message content of *Exchange1 of Seller -> Buyer* example is identical to the content of the *Exchange1 of Seller -> Buyer* in the [Concealed Shortage \(Have Current Order Fulfilled\)](#) example.

Reference File: <https://resources.gs1us.org/Portals/0/xml/LotException-ConcealedShortageCancel-SellerExchange1.xml>

```

<?xml version="1.0" encoding="UTF-8"?>
<!-- Lot Exception: Concealed Shortage (Cancel) - Exchange1: Seller -> Buyer-->
<!-- Buyer orders 1 case of 12 lowest saleable units (LSUs). The seller ships 1 case to the
buyer. Seller's IT system reflects there are 12 LSUs in the case.
In reality, there are 11 LSUs that got shipped in the 1 case. -->
<!-- Note: This Seller -> Buyer transaction in this example is identical to the Seller ->
Buyer content for Concealed Shortage (Fulfill) - Exchange1 -->
<epcis:EPCISDocument xmlns:cbvmda="urn:epcglobal:cbv:mda"
xmlns:sbdh="http://www.unece.org/cefact/namespaces/StandardBusinessDocumentHeader"
xmlns:gslushc="http://epcis.gslus.org/hc/ns" xmlns:epcis="urn:epcglobal:epcis:xsd:1"
schemaVersion="1.2" xsi:schemaLocation="urn:epcglobal:epcis:xsd:1 EPCglobal-epcis-1_2.xsd"
xmlns:xsi="http://www.w3.org/2001/XMLSchema-instance" creationDate="2014-04-01T15:14:27.574-
04:00">
  <EPCISHeader>
    <sbdh:StandardBusinessDocumentHeader>
      <sbdh:HeaderVersion>1.0</sbdh:HeaderVersion>
      <sbdh:Sender>
        <sbdh:Identifier
Authority="SGLN">urn:epc:id:sgln:030000.000000.0</sbdh:Identifier>
      </sbdh:Sender>
      <sbdh:Receiver>
        <sbdh:Identifier
Authority="SGLN">urn:epc:id:sgln:0614141.00000.0</sbdh:Identifier>
      </sbdh:Receiver>
      <sbdh:DocumentIdentification>
        <sbdh:Standard>EPCglobal</sbdh:Standard>
        <sbdh:TypeVersion>1.0</sbdh:TypeVersion>
        <sbdh:InstanceIdentifier>1234567874</sbdh:InstanceIdentifier>
        <sbdh:Type>Events</sbdh:Type>
        <sbdh:CreationDateAndTime>2014-04-01T15:14:27.574-04:00</sbdh:CreationDateAndTime>
      </sbdh:DocumentIdentification>
    </sbdh:StandardBusinessDocumentHeader>
    <extension>
      <EPCISMasterData>
        <VocabularyList>
          <Vocabulary type="urn:epcglobal:epcis:vtype:EPCClass">
            <VocabularyElementList>
              <VocabularyElement id="urn:epc:class:lgtn:030000.0000002.L1">
                <attribute id="urn:epcglobal:cbv:mda:itemExpirationDate">2017-10-
31</attribute>
              </VocabularyElement>

```



```

        <!-- Product Master data attributes for a LSU -->
        <VocabularyElement id="urn:epc:idpat:sgtin:030000.0000002.*">
            <attribute
id="urn:epcglobal:cbv:mda#additionalTradeItemIdentification">00000000002</attribute>
            <attribute
id="urn:epcglobal:cbv:mda#additionalTradeItemIdentificationTypeCode">FDA_NDC_11</attribute>
            <attribute
id="urn:epcglobal:cbv:mda#regulatedProductName">Epcistra</attribute>
            <attribute
id="urn:epcglobal:cbv:mda#manufacturerOfTradeItemPartyName">GS1 Pharma LLC</attribute>
            <attribute id="urn:epcglobal:cbv:mda#dosageFormType">PILL</attribute>
            <attribute
id="urn:epcglobal:cbv:mda#strengthDescription">100mg</attribute>
            <attribute id="urn:epcglobal:cbv:mda#netContentDescription">480
pills</attribute>
        </VocabularyElement>
    </VocabularyElementList>
</Vocabulary>
<Vocabulary type="urn:epcglobal:epcis:vtype:Location">
    <VocabularyElementList>
        <VocabularyElement id="urn:epc:id:sgln:030000.000000.0">
            <attribute id="urn:epcglobal:cbv:mda#name">GS1 Pharma LLC</attribute>
            <attribute id="urn:epcglobal:cbv:mda#streetAddressOne">1295 S George
Ave</attribute>
            <attribute id="urn:epcglobal:cbv:mda#streetAddressTwo">Room
378</attribute>
            <attribute id="urn:epcglobal:cbv:mda#city">Washington</attribute>
            <attribute id="urn:epcglobal:cbv:mda#state">DC</attribute>
            <attribute id="urn:epcglobal:cbv:mda#postalCode">12345-
6789</attribute>
            <attribute id="urn:epcglobal:cbv:mda#countryCode">US</attribute>
        </VocabularyElement>
        <VocabularyElement id="urn:epc:id:sgln:0614141.00000.0">
            <attribute id="urn:epcglobal:cbv:mda#name">GS1 Drug Distro
LLC</attribute>
            <attribute id="urn:epcglobal:cbv:mda#streetAddressOne">230 Park Ave
S</attribute>
            <attribute id="urn:epcglobal:cbv:mda#city">New York</attribute>
            <attribute id="urn:epcglobal:cbv:mda#state">NY</attribute>
            <attribute id="urn:epcglobal:cbv:mda#postalCode">10003-
1502</attribute>
            <attribute id="urn:epcglobal:cbv:mda#countryCode">US</attribute>
        </VocabularyElement>
    </VocabularyElementList>
</Vocabulary>
</VocabularyList>
</EPCISMasterData>
</extension>
<gslushc:dscsaTransactionStatement>
    <gslushc:affirmTransactionStatement>true</gslushc:affirmTransactionStatement>
    <gslushc:legalNotice>Seller has complied with each applicable subsection of FDCA Sec.
581 (27) (A) - (G).</gslushc:legalNotice>
</gslushc:dscsaTransactionStatement>
</EPCISHeader>
<EPCISBody>
    <EventList>
        <!-- Transaction Information (TI) -->
        <ObjectEvent>
            <eventTime>2014-04-01T10:11:12Z</eventTime>
            <eventTimeZoneOffset>-05:00</eventTimeZoneOffset>
            <epcList/>

```



```

<action>OBSERVE</action>
<bizStep>urn:epcglobal:cbv:bizstep:shipping</bizStep>
<disposition>urn:epcglobal:cbv:disp:in_transit</disposition>
<readPoint>
  <id>urn:epc:id:sgln:030000.000000.0</id>
</readPoint>
<extension>
  <quantityList>
    <!-- In this example, the EPCIS quantityElement data structure contains the
lgtin for the lowest saleable unit (LSU) and the quantity value is given in terms of LSUs. For
this example scenario, each ordered case contains 12 LSUs. Hence, the quantity value will be
computed by multiplying the order case quantity with 12 LSUs. -->
    <quantityElement>
      <!-- Seller ships 1 case of 12 LSUs -->
      <epcClass>urn:epc:class:lgtin:030000.0000002.L1</epcClass>
      <quantity>12</quantity>
    </quantityElement>
  </quantityList>
  <sourceList>
    <source
type="urn:epcglobal:cbv:sdt:owning_party">urn:epc:id:sgln:030000.000000.0</source>
  </sourceList>
  <destinationList>
    <destination
type="urn:epcglobal:cbv:sdt:owning_party">urn:epc:id:sgln:0614141.00000.0</destination>
  </destinationList>
</extension>
</ObjectEvent>
</EventList>
</EPCISBody>
</epcis:EPCISDocument>

```

### 12.5.2.2 Sample XML: Buyer Receives Product (1st Receipt)



**Note:** The message content of *Buyer Receives Product (1<sup>st</sup> Receipt)* in this example is identical to the content of the *Buyer Receives Product (1<sup>st</sup> Receipt)* in the [Concealed Shortage \(Have Current Order Fulfilled\)](#) example.

Reference File: <https://resources.gs1us.org/Portals/0/xml/LotException-ConcealedShortageCancel-BuyerReceives-1st.xml>

```

<?xml version="1.0" encoding="UTF-8"?>
<!-- Lot Exception: Concealed Shortage (Cancel) - Buyer Receives Product (First Receipt) -->
<!-- After opening the case, buyer discovers 1 missing LSU and receives the 11 lowest saleable
units (LSUs) found in the case. -->
<!-- Note: This Receiving transaction in this example is identical to the content for
Concealed Shortage (Fulfill): Buyer Receives Product (First Receipt) -->
<epcis:EPCISDocument xmlns:cbvmda="urn:epcglobal:cbv:mda"
xmlns:sbdh="http://www.unece.org/cefact/namespaces/StandardBusinessDocumentHeader"
xmlns:gslushc="http://epcis.gs1us.org/hc/ns" xmlns:epcis="urn:epcglobal:epcis:xsd:1"
schemaVersion="1.2" xsi:schemaLocation="urn:epcglobal:epcis:xsd:1 EPCglobal-epcis-1_2.xsd"
xmlns:xsi="http://www.w3.org/2001/XMLSchema-instance" creationDate="2014-04-02T15:14:27.574-
04:00">
  <EPCISHeader>
    <sbdh:StandardBusinessDocumentHeader>
      <sbdh:HeaderVersion>1.0</sbdh:HeaderVersion>
      <sbdh:Sender>

```

```

        <sbdh:Identifier
Authority="SGLN">urn:epc:id:sgln:0614141.00000.0</sbdh:Identifier>
    </sbdh:Sender>
    <sbdh:Receiver>
    <sbdh:Identifier
Authority="SGLN">urn:epc:id:sgln:0614141.11111.0</sbdh:Identifier>
    </sbdh:Receiver>
    <sbdh:DocumentIdentification>
    <sbdh:Standard>EPCglobal</sbdh:Standard>
    <sbdh:TypeVersion>1.0</sbdh:TypeVersion>
    <sbdh:InstanceIdentifier>1234567875</sbdh:InstanceIdentifier>
    <sbdh:Type>Events</sbdh:Type>
    <sbdh:CreationDateAndTime>2014-04-02T15:14:27.574-04:00</sbdh:CreationDateAndTime>
    </sbdh:DocumentIdentification>
</sbdh:StandardBusinessDocumentHeader>
<extension>
    <EPCISMasterData>
    <VocabularyList>
    <Vocabulary type="urn:epcglobal:epcis:vtype:EPCClass">
    <VocabularyElementList>
    <VocabularyElement id="urn:epc:class:lgtin:030000.0000002.L1">
    <attribute id="urn:epcglobal:cbv:mda#itemExpirationDate">2017-10-
31</attribute>
    </VocabularyElement>
    <!-- Product Master data attributes for a lowest saleable unit (LSU) -->
    <VocabularyElement id="urn:epc:idpat:sgtin:030000.0000002.*">
    <attribute
id="urn:epcglobal:cbv:mda#additionalTradeItemIdentification">00000000002</attribute>
    <attribute
id="urn:epcglobal:cbv:mda#additionalTradeItemIdentificationTypeCode">FDA_NDC_11</attribute>
    <attribute
id="urn:epcglobal:cbv:mda#regulatedProductName">Epcistra</attribute>
    <attribute
id="urn:epcglobal:cbv:mda#manufacturerOfTradeItemPartyName">GS1 Pharma LLC</attribute>
    <attribute id="urn:epcglobal:cbv:mda#dosageFormType">PILL</attribute>
    <attribute
id="urn:epcglobal:cbv:mda#strengthDescription">100mg</attribute>
    <attribute id="urn:epcglobal:cbv:mda#netContentDescription">480
pills</attribute>
    </VocabularyElement>
    </VocabularyElementList>
    </Vocabulary>
    <Vocabulary type="urn:epcglobal:epcis:vtype:Location">
    <VocabularyElementList>
    <VocabularyElement id="urn:epc:id:sgln:030000.000000.0">
    <attribute id="urn:epcglobal:cbv:mda#name">GS1 Pharma LLC</attribute>
    <attribute id="urn:epcglobal:cbv:mda#streetAddressOne">1295 S George
Ave</attribute>
    <attribute id="urn:epcglobal:cbv:mda#streetAddressTwo">Room
378</attribute>
    <attribute id="urn:epcglobal:cbv:mda#city">Washington</attribute>
    <attribute id="urn:epcglobal:cbv:mda#state">DC</attribute>
    <attribute id="urn:epcglobal:cbv:mda#postalCode">12345-
6789</attribute>
    <attribute id="urn:epcglobal:cbv:mda#countryCode">US</attribute>
    </VocabularyElement>
    <VocabularyElement id="urn:epc:id:sgln:0614141.00000.0">
    <attribute id="urn:epcglobal:cbv:mda#name">GS1 Drug Distro
LLC</attribute>
    <attribute id="urn:epcglobal:cbv:mda#streetAddressOne">230 Park Ave
S</attribute>

```

```

    <attribute id="urn:epcglobal:cbv:mda#city">New York</attribute>
    <attribute id="urn:epcglobal:cbv:mda#state">NY</attribute>
    <attribute id="urn:epcglobal:cbv:mda#postalCode">10003-
1502</attribute>
        <attribute id="urn:epcglobal:cbv:mda#countryCode">US</attribute>
    </VocabularyElement>
  </VocabularyElementList>
</Vocabulary>
</VocabularyList>
</EPCISMasterData>
</extension>
</EPCISHeader>
<EPCISBody>
  <EventList>
    <ObjectEvent>
      <eventTime>2014-04-02T10:11:12Z</eventTime>
      <eventTimeZoneOffset>-05:00</eventTimeZoneOffset>
      <epcList/>
      <action>OBSERVE</action>
      <bizStep>urn:epcglobal:cbv:bizstep:receiving</bizStep>
      <disposition>urn:epcglobal:cbv:disp:in_progress</disposition>
      <readPoint>
        <id>urn:epc:id:sgln:0614141.00000.0</id>
      </readPoint>
      <extension>
        <quantityList>
          <!-- In this example, the EPCIS quantityElement data structure contains the
lgtin for the lowest saleable unit (LSU) and the quantity value is given in terms of LSUs. -->
          <quantityElement>
            <!-- Buyer receives 11 LSUs into inventory -->
            <epcClass>urn:epc:class:lgtin:030000.0000002.L1</epcClass>
            <quantity>11</quantity>
          </quantityElement>
        </quantityList>
        <sourceList>
          <source
type="urn:epcglobal:cbv:sdt:owning_party">urn:epc:id:sgln:030000.000000.0</source>
        </sourceList>
        <destinationList>
          <destination
type="urn:epcglobal:cbv:sdt:owning_party">urn:epc:id:sgln:0614141.00000.0</destination>
        </destinationList>
      </extension>
    </ObjectEvent>
  </EventList>
</EPCISBody>
</epcis:EPCISDocument>

```

### 12.5.2.3 Sample XML: Seller Corrects Shipment Data

 **Note:** The message content of *Seller Corrects Shipment Data* in this example is identical to the content of the *Seller Corrects Shipment Data* in the [Concealed Shortage \(Have Current Order Fulfilled\)](#) example.

Reference File: <https://resources.gs1us.org/Portals/0/xml/LotException-ConcealedShortageCancel-SellerCorrectsShipmentData.xml>

```
<?xml version="1.0" encoding="UTF-8"?>
<!-- Lot Exception: Concealed Shortage (Cancel) - Seller corrects shipment data -->
<!-- After getting notified that only 11 lowest saleable units (LSUs) were found in the case,
seller investigates the discrepancy and resolves issue by generating voidShipping Event for the
1 missing LSU -->
<!-- Note: The voidShipping and shipping event corrective transactions in this example are
identical to the content for Concealed Shortage (Fulfill): Seller corrects shipment data -->
<epcis:EPCISDocument xmlns:cbvmda="urn:epcglobal:cbv:mda"
xmlns:sbdh="http://www.unece.org/cefact/namespaces/StandardBusinessDocumentHeader"
xmlns:gslushc="http://epcis.gs1us.org/hc/ns" xmlns:epcis="urn:epcglobal:epcis:xsd:1"
schemaVersion="1.2" xsi:schemaLocation="urn:epcglobal:epcis:xsd:1 EPCglobal-epcis-1_2.xsd"
xmlns:xsi="http://www.w3.org/2001/XMLSchema-instance" creationDate="2014-04-03T15:14:27.574-
04:00">
  <EPCISHeader>
    <sbdh:StandardBusinessDocumentHeader>
      <sbdh:HeaderVersion>1.0</sbdh:HeaderVersion>
      <sbdh:Sender>
        <sbdh:Identifier
Authority="SGLN">urn:epc:id:sgln:030000.000000.0</sbdh:Identifier>
        </sbdh:Sender>
      <sbdh:Receiver>
        <sbdh:Identifier
Authority="SGLN">urn:epc:id:sgln:030000.000001.0</sbdh:Identifier>
        </sbdh:Receiver>
      <sbdh:DocumentIdentification>
        <sbdh:Standard>EPCglobal</sbdh:Standard>
        <sbdh:TypeVersion>1.0</sbdh:TypeVersion>
        <sbdh:InstanceIdentifier>1234567876</sbdh:InstanceIdentifier>
        <sbdh:Type>Events</sbdh:Type>
        <sbdh:CreationDateAndTime>2014-04-03T15:14:27.574-04:00</sbdh:CreationDateAndTime>
      </sbdh:DocumentIdentification>
    </sbdh:StandardBusinessDocumentHeader>
    <extension>
      <EPCISMasterData>
        <VocabularyList>
          <Vocabulary type="urn:epcglobal:epcis:vtype:EPCClass">
            <VocabularyElementList>
              <VocabularyElement id="urn:epc:class:lgtin:030000.0000002.L1">
                <attribute id="urn:epcglobal:cbv:mda#itemExpirationDate">2017-10-
31</attribute>
              </VocabularyElement>
              <!-- Product Master data attributes for a lowest saleable unit (LSU) -->
              <VocabularyElement id="urn:epc:idpat:sgtin:030000.0000002.*">
                <attribute
id="urn:epcglobal:cbv:mda#additionalTradeItemIdentification">0000000002</attribute>
                <attribute
id="urn:epcglobal:cbv:mda#additionalTradeItemIdentificationTypeCode">FDA_NDC_11</attribute>
                <attribute
id="urn:epcglobal:cbv:mda#regulatedProductName">Epcistra</attribute>
            </VocabularyElementList>
          </Vocabulary>
        </VocabularyList>
      </EPCISMasterData>
    </extension>
  </epcis:EPCISDocument>

```

```

        <attribute
id="urn:epcglobal:cbv:mda#manufacturerOfTradeItemPartyName">GS1 Pharma LLC</attribute>
        <attribute id="urn:epcglobal:cbv:mda#dosageFormType">PILL</attribute>
        <attribute
id="urn:epcglobal:cbv:mda#strengthDescription">100mg</attribute>
        <attribute id="urn:epcglobal:cbv:mda#netContentDescription">40
pills</attribute>
    </VocabularyElement>
</VocabularyElementList>
</Vocabulary>
<Vocabulary type="urn:epcglobal:epcis:vtype:Location">
    <VocabularyElementList>
        <VocabularyElement id="urn:epc:id:sgln:030000.000000.0">
            <attribute id="urn:epcglobal:cbv:mda#name">GS1 Pharma LLC</attribute>
            <attribute id="urn:epcglobal:cbv:mda#streetAddressOne">1295 S George
Ave</attribute>
            <attribute id="urn:epcglobal:cbv:mda#streetAddressTwo">Room
378</attribute>
            <attribute id="urn:epcglobal:cbv:mda#city">Washington</attribute>
            <attribute id="urn:epcglobal:cbv:mda#state">DC</attribute>
            <attribute id="urn:epcglobal:cbv:mda#postalCode">12345-
6789</attribute>
            <attribute id="urn:epcglobal:cbv:mda#countryCode">US</attribute>
        </VocabularyElement>
        <VocabularyElement id="urn:epc:id:sgln:0614141.00000.0">
            <attribute id="urn:epcglobal:cbv:mda#name">GS1 Drug Distro
LLC</attribute>
            <attribute id="urn:epcglobal:cbv:mda#streetAddressOne">230 Park Ave
S</attribute>
            <attribute id="urn:epcglobal:cbv:mda#city">New York</attribute>
            <attribute id="urn:epcglobal:cbv:mda#state">NY</attribute>
            <attribute id="urn:epcglobal:cbv:mda#postalCode">10003-
1502</attribute>
            <attribute id="urn:epcglobal:cbv:mda#countryCode">US</attribute>
        </VocabularyElement>
    </VocabularyElementList>
</Vocabulary>
</VocabularyList>
</EPCISMasterData>
</extension>
</EPCISHeader>
<EPCISBody>
    <EventList>
        <ObjectEvent>
            <eventTime>2014-04-03T10:11:12Z</eventTime>
            <eventTimeZoneOffset>-05:00</eventTimeZoneOffset>
            <epcList/>
            <action>OBSERVE</action>
            <bizStep>urn:epcglobal:cbv:bizstep:void_shipping</bizStep>
            <disposition>urn:epcglobal:cbv:disp:in_progress</disposition>
            <readPoint>
                <id>urn:epc:id:sgln:030000.000000.0</id>
            </readPoint>
            <extension>
                <quantityList>
                    <!-- In this example, the EPCIS quantityElement data structure contains the
lgtin for the lowest saleable unit (LSU) and the quantity value is given in terms of LSUs. -->
                    <quantityElement>
                        <!-- Voiding the shipment of 1 LSU that was not included in the shipment
-->
                    <epcClass>urn:epc:class:lgtin:030000.0000002.L1</epcClass>

```

```
        <quantity>1</quantity>
      </quantityElement>
    </quantityList>
    <sourceList>
      <source
type="urn:epcglobal:cbv:sdt:owning_party">urn:epc:id:sgln:030000.000000.0</source>
      </sourceList>
    <destinationList>
      <destination
type="urn:epcglobal:cbv:sdt:owning_party">urn:epc:id:sgln:0614141.00000.0</destination>
      </destinationList>
    </extension>
  </ObjectEvent>
</EventList>
</EPCISBody>
</epcis:EPCISDocument>
```

## 12.6 Incorrect Buyer (Sold-to)

### 12.6.1 Sample XML: Exchange1 - Seller → Buyer

Reference File: <https://resources.gs1us.org/Portals/0/xml/LotException-IncorrectBuyerSoldTo-SellerExchange1.xml>

```
<?xml version="1.0" encoding="UTF-8"?>
<!-- Lot Exception: INCORRECT BUYER (SOLD-TO) - Exchange1: Seller -> Buyer-->
<!-- Seller ships correct shipment to the correct Buyer location/entity; however, the Buyer
information in the EPCIS event is incorrect. -->
<epcis:EPCISDocument xmlns:cbvmda="urn:epcglobal:cbv:mda"
xmlns:sbdh="http://www.unece.org/cefact/namespaces/StandardBusinessDocumentHeader"
xmlns:gslushc="http://epcis.gs1us.org/hc/ns" xmlns:epcis="urn:epcglobal:epcis:xsd:1"
schemaVersion="1.2" xsi:schemaLocation="urn:epcglobal:epcis:xsd:1 EPCglobal-epcis-1_2.xsd"
xmlns:xsi="http://www.w3.org/2001/XMLSchema-instance" creationDate="2014-04-01T15:14:27.574-
04:00">
  <EPCISHeader>
    <sbdh:StandardBusinessDocumentHeader>
      <sbdh:HeaderVersion>1.0</sbdh:HeaderVersion>
      <sbdh:Sender>
        <sbdh:Identifier
Authority="SGLN">urn:epc:id:sgln:030000.000000.0</sbdh:Identifier>
        </sbdh:Sender>
      <sbdh:Receiver>
        <sbdh:Identifier
Authority="SGLN">urn:epc:id:sgln:0614141.00000.0</sbdh:Identifier>
        </sbdh:Receiver>
      <sbdh:DocumentIdentification>
        <sbdh:Standard>EPCglobal</sbdh:Standard>
        <sbdh:TypeVersion>1.0</sbdh:TypeVersion>
        <sbdh:InstanceIdentifier>1234567860</sbdh:InstanceIdentifier>
        <sbdh:Type>Events</sbdh:Type>
        <sbdh:CreationDateAndTime>2014-04-01T15:14:27.574-04:00</sbdh:CreationDateAndTime>
      </sbdh:DocumentIdentification>
    </sbdh:StandardBusinessDocumentHeader>
    <extension>
      <EPCISMasterData>
        <VocabularyList>
          <Vocabulary type="urn:epcglobal:epcis:vtype:EPCClass">
            <VocabularyElementList>
              <VocabularyElement id="urn:epc:class:lgtn:030000.0000001.L1">
                <attribute id="urn:epcglobal:cbv:mda#itemExpirationDate">2017-10-
31</attribute>
              </VocabularyElement>
              <VocabularyElement id="urn:epc:idpat:sgtin:030000.0000001.*">
                <attribute
id="urn:epcglobal:cbv:mda#additionalTradeItemIdentification">0000000001</attribute>
                <attribute
id="urn:epcglobal:cbv:mda#additionalTradeItemIdentificationTypeCode">FDA_NDC_11</attribute>
                <attribute
id="urn:epcglobal:cbv:mda#regulatedProductName">Epcistra</attribute>
                <attribute
id="urn:epcglobal:cbv:mda#manufacturerOfTradeItemPartyName">GS1 Pharma LLC</attribute>
                <attribute id="urn:epcglobal:cbv:mda#dosageFormType">PILL</attribute>
                <attribute
id="urn:epcglobal:cbv:mda#strengthDescription">100mg</attribute>
                <attribute id="urn:epcglobal:cbv:mda#netContentDescription">500
pills</attribute>
              </VocabularyElement>
            </VocabularyElementList>
          </Vocabulary>
        </VocabularyList>
      </EPCISMasterData>
    </extension>
  </EPCISHeader>
</epcis:EPCISDocument>
```

```

        </VocabularyElementList>
    </Vocabulary>
    <Vocabulary type="urn:epcglobal:epcis:vtype:Location">
        <VocabularyElementList>
            <VocabularyElement id="urn:epc:id:sgln:030000.000000.0">
                <attribute id="urn:epcglobal:cbv:mda#name">GS1 Pharma LLC</attribute>
                <attribute id="urn:epcglobal:cbv:mda#streetAddressOne">1295 S George
Ave</attribute>
                <attribute id="urn:epcglobal:cbv:mda#streetAddressTwo">Room
378</attribute>
                <attribute id="urn:epcglobal:cbv:mda#city">Washington</attribute>
                <attribute id="urn:epcglobal:cbv:mda#state">DC</attribute>
                <attribute id="urn:epcglobal:cbv:mda#postalCode">12345-
6789</attribute>
                <attribute id="urn:epcglobal:cbv:mda#countryCode">US</attribute>
            </VocabularyElement>
            <!-- Buyer B -->
            <VocabularyElement id="urn:epc:id:sgln:0614141.000000.0">
                <attribute id="urn:epcglobal:cbv:mda#name">GS1 Drug Distro
LLC</attribute>
                <attribute id="urn:epcglobal:cbv:mda#streetAddressOne">230 Park Ave
S</attribute>
                <attribute id="urn:epcglobal:cbv:mda#city">New York</attribute>
                <attribute id="urn:epcglobal:cbv:mda#state">NY</attribute>
                <attribute id="urn:epcglobal:cbv:mda#postalCode">10003-
1502</attribute>
                <attribute id="urn:epcglobal:cbv:mda#countryCode">US</attribute>
            </VocabularyElement>
        </VocabularyElementList>
    </Vocabulary>
</VocabularyList>
</EPCISMasterData>
</extension>
<gslushc:dscsaTransactionStatement>
    <gslushc:affirmTransactionStatement>true</gslushc:affirmTransactionStatement>
    <gslushc:legalNotice>Seller has complied with each applicable subsection of FDCA Sec.
581 (27) (A) - (G).</gslushc:legalNotice>
</gslushc:dscsaTransactionStatement>
</EPCISHeader>
<EPCISBody>
    <EventList>
        <!-- Transaction Information (TI) -->
        <ObjectEvent>
            <eventTime>2014-04-01T10:11:12Z</eventTime>
            <eventTimeZoneOffset>-05:00</eventTimeZoneOffset>
            <epcList/>
            <action>OBSERVE</action>
            <bizStep>urn:epcglobal:cbv:bizstep:shipping</bizStep>
            <disposition>urn:epcglobal:cbv:disp:in_transit</disposition>
            <readPoint>
                <id>urn:epc:id:sgln:030000.000000.0</id>
            </readPoint>
            <extension>
                <quantityList>
                    <!-- In this example, the EPCIS quantityElement data structure contains the
lgtin for the lowest saleable unit (LSU) and the quantity value is given in terms of LSUs. For
this example scenario, each ordered case contains 12 LSUs. Hence, the quantity value will be
computed by multiplying the order case quantity with 12 LSUs. -->
                    <quantityElement>
                        <epcClass>urn:epc:class:lgtin:030000.0000001.L1</epcClass>
                        <quantity>120</quantity>
                    </quantityElement>
                </quantityList>
            </extension>
        </ObjectEvent>
    </EventList>
</EPCISBody>
</EPCISMessage>
</EPCISEnvelope>

```



```

        </quantityElement>
    </quantityList>
    <sourceList>
        <source
type="urn:epcglobal:cbv:sdt:owning_party">urn:epc:id:sgln:030000.000000.0</source>
        </sourceList>
    <destinationList>
        <!-- Incorrect Sold-To information -->
        <destination
type="urn:epcglobal:cbv:sdt:owning_party">urn:epc:id:sgln:0614141.00000.0</destination>
        </destinationList>
    </extension>
</ObjectEvent>
</EventList>
</EPCISBody>
</epcis:EPCISDocument>

```

## 12.6.2 Sample XML: Seller Corrects Shipment Data

Reference File: <https://resources.gs1us.org/Portals/0/xml/LotException-IncorrectBuyerSoldTo-SellerCorrectsShipmentData.xml>

```

<?xml version="1.0" encoding="UTF-8"?>
<!-- Lot Exception: INCORRECT BUYER (SOLD-TO) - Seller corrects shipment data -->
<!-- Seller investigates discrepancy and resolves issue by generating voidShipping event for
the previously generated shipping event with the incorrect Sold-To information -->
<epcis:EPCISDocument xmlns:cbvmda="urn:epcglobal:cbv:mda"
xmlns:sbdh="http://www.unece.org/cefact/namespaces/StandardBusinessDocumentHeader"
xmlns:gslushc="http://epcis.gs1us.org/hc/ns" xmlns:epcis="urn:epcglobal:epcis:xsd:1"
schemaVersion="1.2" xsi:schemaLocation="urn:epcglobal:epcis:xsd:1 EPCglobal-epcis-1_2.xsd"
xmlns:xsi="http://www.w3.org/2001/XMLSchema-instance" creationDate="2014-04-03T15:14:27.574-
04:00">
    <EPCISHeader>
        <sbdh:StandardBusinessDocumentHeader>
            <sbdh:HeaderVersion>1.0</sbdh:HeaderVersion>
            <sbdh:Sender>
                <sbdh:Identifier
Authority="SGLN">urn:epc:id:sgln:030000.000000.0</sbdh:Identifier>
            </sbdh:Sender>
            <sbdh:Receiver>
                <sbdh:Identifier
Authority="SGLN">urn:epc:id:sgln:030000.000001.0</sbdh:Identifier>
            </sbdh:Receiver>
            <sbdh:DocumentIdentification>
                <sbdh:Standard>EPCglobal</sbdh:Standard>
                <sbdh:TypeVersion>1.0</sbdh:TypeVersion>
                <sbdh:InstanceIdentifier>1234567861</sbdh:InstanceIdentifier>
                <sbdh:Type>Events</sbdh:Type>
                <sbdh:CreationDateAndTime>2014-04-03T15:14:27.574-04:00</sbdh:CreationDateAndTime>
            </sbdh:DocumentIdentification>
        </sbdh:StandardBusinessDocumentHeader>
        <extension>
            <EPCISMasterData>
                <VocabularyList>
                    <Vocabulary type="urn:epcglobal:epcis:vtype:EPCClass">
                        <VocabularyElementList>
                            <VocabularyElement id="urn:epc:class:lgtn:030000.0000001.L1">
                                <attribute id="urn:epcglobal:cbv:mda:itemExpirationDate">2017-10-
31</attribute>
                            </VocabularyElement>

```

```

        <VocabularyElement id="urn:epc:idpat:sgtin:030000.0000001.*">
            <attribute
id="urn:epcglobal:cbv:mda#additionalTradeItemIdentification">0000000001</attribute>
            <attribute
id="urn:epcglobal:cbv:mda#additionalTradeItemIdentificationTypeCode">FDA_NDC_11</attribute>
            <attribute
id="urn:epcglobal:cbv:mda#regulatedProductName">Epcistra</attribute>
            <attribute
id="urn:epcglobal:cbv:mda#manufacturerOfTradeItemPartyName">GS1 Pharma LLC</attribute>
            <attribute id="urn:epcglobal:cbv:mda#dosageFormType">PILL</attribute>
            <attribute
id="urn:epcglobal:cbv:mda#strengthDescription">100mg</attribute>
            <attribute id="urn:epcglobal:cbv:mda#netContentDescription">500
pills</attribute>
        </VocabularyElement>
    </VocabularyElementList>
</Vocabulary>
<Vocabulary type="urn:epcglobal:epcis:vtype:Location">
    <VocabularyElementList>
        <VocabularyElement id="urn:epc:id:sgln:030000.000000.0">
            <attribute id="urn:epcglobal:cbv:mda#name">GS1 Pharma LLC</attribute>
            <attribute id="urn:epcglobal:cbv:mda#streetAddressOne">1295 S George
Ave</attribute>
            <attribute id="urn:epcglobal:cbv:mda#streetAddressTwo">Room
378</attribute>
            <attribute id="urn:epcglobal:cbv:mda#city">Washington</attribute>
            <attribute id="urn:epcglobal:cbv:mda#state">DC</attribute>
            <attribute id="urn:epcglobal:cbv:mda#postalCode">12345-
6789</attribute>
            <attribute id="urn:epcglobal:cbv:mda#countryCode">US</attribute>
        </VocabularyElement>
        <!-- Buyer B -->
        <VocabularyElement id="urn:epc:id:sgln:0614141.00000.0">
            <attribute id="urn:epcglobal:cbv:mda#name">GS1 Drug Distro
LLC</attribute>
            <attribute id="urn:epcglobal:cbv:mda#streetAddressOne">230 Park Ave
S</attribute>
            <attribute id="urn:epcglobal:cbv:mda#city">New York</attribute>
            <attribute id="urn:epcglobal:cbv:mda#state">NY</attribute>
            <attribute id="urn:epcglobal:cbv:mda#postalCode">10003-
1502</attribute>
            <attribute id="urn:epcglobal:cbv:mda#countryCode">US</attribute>
        </VocabularyElement>
    </VocabularyElementList>
</Vocabulary>
</VocabularyList>
</EPCISMasterData>
</extension>
</EPCISHeader>
<EPCISBody>
    <EventList>
        <ObjectEvent>
            <eventTime>2014-04-03T10:11:12Z</eventTime>
            <eventTimeZoneOffset>-05:00</eventTimeZoneOffset>
            <epcList/>
            <action>OBSERVE</action>
            <bizStep>urn:epcglobal:cbv:bizstep:void_shipping</bizStep>
            <disposition>urn:epcglobal:cbv:disp:in_progress</disposition>
            <readPoint>
                <id>urn:epc:id:sgln:030000.000000.0</id>
            </readPoint>
        </ObjectEvent>
    </EventList>
</EPCISBody>
</EPCIS>

```

```

    <extension>
      <quantityList>
        <!-- In this example, the EPCIS quantityElement data structure contains the
lgtin for the lowest saleable unit (LSU) and the quantity value is given in terms of LSUs. For
this example scenario, each ordered case contains 12 LSUs. Hence, the quantity value will be
computed by multiplying the order case quantity with 12 LSUs. -->
        <quantityElement>
          <epcClass>urn:epc:class:lgtin:030000.0000001.L1</epcClass>
          <quantity>120</quantity>
        </quantityElement>
      </quantityList>
      <sourceList>
        <source
type="urn:epcglobal:cbv:sdt:owning_party">urn:epc:id:sgln:030000.000000.0</source>
      </sourceList>
      <destinationList>
        <!-- Incorrect Sold-To information -->
        <destination
type="urn:epcglobal:cbv:sdt:owning_party">urn:epc:id:sgln:0614141.00000.0</destination>
      </destinationList>
    </extension>
  </ObjectEvent>
</EventList>
</EPCISBody>
</epcis:EPCISDocument>

```

### 12.6.3 Sample XML: Exchange2 - Seller → Buyer

Reference File: <https://resources.gs1us.org/Portals/0/xml/LotException-IncorrectBuyerSoldTo-SellerExchange2.xml>

```

<?xml version="1.0" encoding="UTF-8"?>
<!-- Lot Exception: INCORRECT BUYER (SOLD-TO) - Exchange2: Seller -> Buyer-->
<!-- Seller generates shipping event with correct Sold-To information. -->
<epcis:EPCISDocument xmlns:cbvmda="urn:epcglobal:cbv:mda"
xmlns:sbdh="http://www.unece.org/cefact/namespaces/StandardBusinessDocumentHeader"
xmlns:gslushc="http://epcis.gs1us.org/hc/ns" xmlns:epcis="urn:epcglobal:epcis:xsd:1"
schemaVersion="1.2" xsi:schemaLocation="urn:epcglobal:epcis:xsd:1 EPCglobal-epcis-1_2.xsd"
xmlns:xsi="http://www.w3.org/2001/XMLSchema-instance" creationDate="2014-04-04T15:14:27.574-
04:00">
  <EPCISHeader>
    <sbdh:StandardBusinessDocumentHeader>
      <sbdh:HeaderVersion>1.0</sbdh:HeaderVersion>
      <sbdh:Sender>
        <sbdh:Identifier
Authority="SGLN">urn:epc:id:sgln:030000.000000.0</sbdh:Identifier>
      </sbdh:Sender>
      <sbdh:Receiver>
        <sbdh:Identifier
Authority="SGLN">urn:epc:id:sgln:0714141.00000.0</sbdh:Identifier>
      </sbdh:Receiver>
      <sbdh:DocumentIdentification>
        <sbdh:Standard>EPCglobal</sbdh:Standard>
        <sbdh:TypeVersion>1.0</sbdh:TypeVersion>
        <sbdh:InstanceIdentifier>1234567862</sbdh:InstanceIdentifier>
        <sbdh:Type>Events</sbdh:Type>
        <sbdh:CreationDateAndTime>2014-04-04T15:14:27.574-04:00</sbdh:CreationDateAndTime>
      </sbdh:DocumentIdentification>
    </sbdh:StandardBusinessDocumentHeader>
  </extension>

```

```

<EPCISMasterData>
  <VocabularyList>
    <Vocabulary type="urn:epcglobal:epcis:vtype:EPCClass">
      <VocabularyElementList>
        <VocabularyElement id="urn:epc:class:lgtn:030000.0000001.L1">
          <attribute id="urn:epcglobal:cbv:mda#itemExpirationDate">2017-10-
31</attribute>
          </VocabularyElement>
        <VocabularyElement id="urn:epc:idpat:sgtin:030000.0000001.*">
          <attribute
id="urn:epcglobal:cbv:mda#additionalTradeItemIdentification">00000000001</attribute>
          <attribute
id="urn:epcglobal:cbv:mda#additionalTradeItemIdentificationTypeCode">FDA_NDC_11</attribute>
          <attribute
id="urn:epcglobal:cbv:mda#regulatedProductName">Epcistra</attribute>
          <attribute
id="urn:epcglobal:cbv:mda#manufacturerOfTradeItemPartyName">GS1 Pharma LLC</attribute>
          <attribute id="urn:epcglobal:cbv:mda#dosageFormType">PILL</attribute>
          <attribute
id="urn:epcglobal:cbv:mda#strengthDescription">100mg</attribute>
          <attribute id="urn:epcglobal:cbv:mda#netContentDescription">500
pills</attribute>
          </VocabularyElement>
        </VocabularyElementList>
      </Vocabulary>
    <Vocabulary type="urn:epcglobal:epcis:vtype:Location">
      <VocabularyElementList>
        <VocabularyElement id="urn:epc:id:sgln:030000.000000.0">
          <attribute id="urn:epcglobal:cbv:mda#name">GS1 Pharma LLC</attribute>
          <attribute id="urn:epcglobal:cbv:mda#streetAddressOne">1295 S George
Ave</attribute>
          <attribute id="urn:epcglobal:cbv:mda#streetAddressTwo">Room
378</attribute>
          <attribute id="urn:epcglobal:cbv:mda#city">Washington</attribute>
          <attribute id="urn:epcglobal:cbv:mda#state">DC</attribute>
          <attribute id="urn:epcglobal:cbv:mda#postalCode">12345-
6789</attribute>
          <attribute id="urn:epcglobal:cbv:mda#countryCode">US</attribute>
        </VocabularyElement>
        <!-- Buyer A -->
        <VocabularyElement id="urn:epc:id:sgln:0714141.00000.0">
          <attribute id="urn:epcglobal:cbv:mda#name">GS1 Wholesaler
LLC</attribute>
          <attribute id="urn:epcglobal:cbv:mda#streetAddressOne">246 Broadway
Ave</attribute>
          <attribute id="urn:epcglobal:cbv:mda#city">New York</attribute>
          <attribute id="urn:epcglobal:cbv:mda#state">NY</attribute>
          <attribute id="urn:epcglobal:cbv:mda#postalCode">10003-
1502</attribute>
          <attribute id="urn:epcglobal:cbv:mda#countryCode">US</attribute>
        </VocabularyElement>
      </VocabularyElementList>
    </Vocabulary>
  </VocabularyList>
</EPCISMasterData>
</extension>
<gslushc:dscsaTransactionStatement>
  <gslushc:affirmTransactionStatement>true</gslushc:affirmTransactionStatement>
  <gslushc:legalNotice>Seller has complied with each applicable subsection of FDCA Sec.
581 (27) (A) - (G).</gslushc:legalNotice>
</gslushc:dscsaTransactionStatement>

```

```

</EPCISHeader>
<EPCISBody>
  <EventList>
    <!-- Transaction Information (TI) -->
    <ObjectEvent>
      <eventTime>2014-04-01T10:11:12Z</eventTime>
      <eventTimeZoneOffset>-05:00</eventTimeZoneOffset>
      <epcList/>
      <action>OBSERVE</action>
      <bizStep>urn:epcglobal:cbv:bizstep:shipping</bizStep>
      <disposition>urn:epcglobal:cbv:disp:in_transit</disposition>
      <readPoint>
        <id>urn:epc:id:sgln:030000.000000.0</id>
      </readPoint>
      <extension>
        <quantityList>
          <!-- In this example, the EPCIS quantityElement data structure contains the
lgtin for the lowest saleable unit (LSU) and the quantity value is given in terms of LSUs. For
this example scenario, each ordered case contains 12 LSUs. Hence, the quantity value will be
computed by multiplying the order case quantity with 12 LSUs. -->
          <quantityElement>
            <epcClass>urn:epc:class:lgtin:030000.0000001.L1</epcClass>
            <quantity>120</quantity>
          </quantityElement>
        </quantityList>
        <sourceList>
          <source
type="urn:epcglobal:cbv:sdt:owning_party">urn:epc:id:sgln:030000.000000.0</source>
        </sourceList>
        <destinationList>
          <!-- Correct Sold-To information -->
          <destination
type="urn:epcglobal:cbv:sdt:owning_party">urn:epc:id:sgln:0714141.00000.0</destination>
        </destinationList>
      </extension>
    </ObjectEvent>
  </EventList>
</EPCISBody>
</epcis:EPCISDocument>

```

## 12.6.4 Sample XML: Buyer Receives Product

Reference File: <https://resources.gs1us.org/Portals/0/xml/LotException-IncorrectBuyerSoldTo-BuyerReceives.xml>

```

<?xml version="1.0" encoding="UTF-8"?>
<!-- Lot Exception: INCORRECT BUYER (SOLD-TO) - Buyer Receives Product -->
<!-- Buyer A receives 10 cases with supporting DSCSA data -->
<epcis:EPCISDocument xmlns:cbvmda="urn:epcglobal:cbv:mda"
xmlns:sbdh="http://www.unece.org/cefact/namespaces/StandardBusinessDocumentHeader"
xmlns:gslushc="http://epcis.gs1us.org/hc/ns" xmlns:epcis="urn:epcglobal:epcis:xsd:1"
schemaVersion="1.2" xsi:schemaLocation="urn:epcglobal:epcis:xsd:1 EPCglobal-epcis-1_2.xsd"
xmlns:xsi="http://www.w3.org/2001/XMLSchema-instance" creationDate="2014-04-05T15:14:27.574-
04:00">
  <EPCISHeader>
    <sbdh:StandardBusinessDocumentHeader>
      <sbdh:HeaderVersion>1.0</sbdh:HeaderVersion>
      <sbdh:Sender>
        <sbdh:Identifier
Authority="SGLN">urn:epc:id:sgln:0714141.00000.0</sbdh:Identifier>

```

```

</sbdh:Sender>
<sbdh:Receiver>
  <sbdh:Identifier
Authority="SGLN">urn:epc:id:sgln:0714141.11111.0</sbdh:Identifier>
</sbdh:Receiver>
<sbdh:DocumentIdentification>
  <sbdh:Standard>EPCglobal</sbdh:Standard>
  <sbdh:TypeVersion>1.0</sbdh:TypeVersion>
  <sbdh:InstanceIdentifier>1234567863</sbdh:InstanceIdentifier>
  <sbdh:Type>Events</sbdh:Type>
  <sbdh:CreationDateAndTime>2014-04-05T15:14:27.574-04:00</sbdh:CreationDateAndTime>
</sbdh:DocumentIdentification>
</sbdh:StandardBusinessDocumentHeader>
<extension>
  <EPCISMasterData>
    <VocabularyList>
      <Vocabulary type="urn:epcglobal:epcis:vtype:EPCClass">
        <VocabularyElementList>
          <VocabularyElement id="urn:epc:class:lgtn:030000.0000001.L1">
            <attribute id="urn:epcglobal:cbv:mda#itemExpirationDate">2017-10-
31</attribute>
          </VocabularyElement>
          <VocabularyElement id="urn:epc:idpat:sgtin:030000.0000001.*">
            <attribute
id="urn:epcglobal:cbv:mda#additionalTradeItemIdentification">0000000001</attribute>
            <attribute
id="urn:epcglobal:cbv:mda#additionalTradeItemIdentificationTypeCode">FDA_NDC_11</attribute>
            <attribute
id="urn:epcglobal:cbv:mda#regulatedProductName">Epcistra</attribute>
            <attribute
id="urn:epcglobal:cbv:mda#manufacturerOfTradeItemPartyName">GS1 Pharma LLC</attribute>
            <attribute id="urn:epcglobal:cbv:mda#dosageFormType">PILL</attribute>
            <attribute
id="urn:epcglobal:cbv:mda#strengthDescription">100mg</attribute>
            <attribute id="urn:epcglobal:cbv:mda#netContentDescription">500
pills</attribute>
          </VocabularyElement>
        </VocabularyElementList>
      </Vocabulary>
      <Vocabulary type="urn:epcglobal:epcis:vtype:Location">
        <VocabularyElementList>
          <VocabularyElement id="urn:epc:id:sgln:030000.000000.0">
            <attribute id="urn:epcglobal:cbv:mda#name">GS1 Pharma LLC</attribute>
            <attribute id="urn:epcglobal:cbv:mda#streetAddressOne">1295 S George
Ave</attribute>
            <attribute id="urn:epcglobal:cbv:mda#streetAddressTwo">Room
378</attribute>
            <attribute id="urn:epcglobal:cbv:mda#city">Washington</attribute>
            <attribute id="urn:epcglobal:cbv:mda#state">DC</attribute>
            <attribute id="urn:epcglobal:cbv:mda#postalCode">12345-
6789</attribute>
            <attribute id="urn:epcglobal:cbv:mda#countryCode">US</attribute>
          </VocabularyElement>
          <!-- Buyer A -->
          <VocabularyElement id="urn:epc:id:sgln:0714141.00000.0">
            <attribute id="urn:epcglobal:cbv:mda#name">GS1 Wholesaler
LLC</attribute>
            <attribute id="urn:epcglobal:cbv:mda#streetAddressOne">246 Broadway
Ave</attribute>
            <attribute id="urn:epcglobal:cbv:mda#city">New York</attribute>
            <attribute id="urn:epcglobal:cbv:mda#state">NY</attribute>

```

```

1502</attribute>
    <attribute id="urn:epcglobal:cbv:mda#postalCode">10003-
    <attribute id="urn:epcglobal:cbv:mda#countryCode">US</attribute>
  </VocabularyElement>
</VocabularyElementList>
</Vocabulary>
</VocabularyList>
</EPCISMasterData>
</extension>
</EPCISHeader>
<EPCISBody>
  <EventList>
    <ObjectEvent>
      <eventTime>2014-04-05T10:11:12Z</eventTime>
      <eventTimeZoneOffset>-05:00</eventTimeZoneOffset>
      <epcList/>
      <action>OBSERVE</action>
      <bizStep>urn:epcglobal:cbv:bizstep:receiving</bizStep>
      <disposition>urn:epcglobal:cbv:disp:in_progress</disposition>
      <readPoint>
        <id>urn:epc:id:sgln:0714141.00000.0</id>
      </readPoint>
      <extension>
        <quantityList>
          <!-- In this example, the EPCIS quantityElement data structure contains the
lgtin for the lowest saleable unit (LSU) and the quantity value is given in terms of LSUs. For
this example scenario, each ordered case contains 12 LSUs. Hence, the quantity value will be
computed by multiplying the order case quantity with 12 LSUs. -->
          <quantityElement>
            <epcClass>urn:epc:class:lgtin:030000.0000001.L1</epcClass>
            <quantity>120</quantity>
          </quantityElement>
        </quantityList>
        <sourceList>
          <source
type="urn:epcglobal:cbv:sdt:owning_party">urn:epc:id:sgln:030000.000000.0</source>
        </sourceList>
        <destinationList>
          <destination
type="urn:epcglobal:cbv:sdt:owning_party">urn:epc:id:sgln:0714141.00000.0</destination>
        </destinationList>
      </extension>
    </ObjectEvent>
  </EventList>
</EPCISBody>
</epcis:EPCISDocument>

```



## 12.7 Incorrect Product Data

### 12.7.1 Sample XML: Exchange1 - Seller → Buyer

Reference File: <https://resources.gs1us.org/Portals/0/xml/LotException-IncorrectProduct-SellerExchange1.xml>

```
<?xml version="1.0" encoding="UTF-8"?>
<!-- Lot Exception: INCORRECT PRODUCT DATA - Exchange1: Seller -> Buyer-->
<!-- Seller physically ships correct product to the Buyer but the incorrect product information
is recorded in the EPCIS Shipping event. -->
<epcis:EPCISDocument xmlns:cbvmda="urn:epcglobal:cbv:mda"
xmlns:sbdh="http://www.unece.org/cefact/namespace/StandardBusinessDocumentHeader"
xmlns:gslushc="http://epcis.gs1us.org/hc/ns" xmlns:epcis="urn:epcglobal:epcis:xsd:1"
schemaVersion="1.2" xsi:schemaLocation="urn:epcglobal:epcis:xsd:1 EPCglobal-epcis-1_2.xsd"
xmlns:xsi="http://www.w3.org/2001/XMLSchema-instance" creationDate="2014-04-01T15:14:27.574-
04:00">
  <EPCISHeader>
    <sbdh:StandardBusinessDocumentHeader>
      <sbdh:HeaderVersion>1.0</sbdh:HeaderVersion>
      <sbdh:Sender>
        <sbdh:Identifier
Authority="SGLN">urn:epc:id:sgln:030000.000000.0</sbdh:Identifier>
        </sbdh:Sender>
      <sbdh:Receiver>
        <sbdh:Identifier
Authority="SGLN">urn:epc:id:sgln:0614141.00000.0</sbdh:Identifier>
        </sbdh:Receiver>
      <sbdh:DocumentIdentification>
        <sbdh:Standard>EPCglobal</sbdh:Standard>
        <sbdh:TypeVersion>1.0</sbdh:TypeVersion>
        <sbdh:InstanceIdentifier>1234567864</sbdh:InstanceIdentifier>
        <sbdh:Type>Events</sbdh:Type>
        <sbdh:CreationDateAndTime>2014-04-01T15:14:27.574-04:00</sbdh:CreationDateAndTime>
      </sbdh:DocumentIdentification>
    </sbdh:StandardBusinessDocumentHeader>
    <extension>
      <EPCISMasterData>
        <VocabularyList>
          <Vocabulary type="urn:epcglobal:epcis:vtype:EPCClass">
            <VocabularyElementList>
              <!-- Product B -->
              <VocabularyElement id="urn:epc:class:lgtin:030000.0000001.L1">
                <attribute id="urn:epcglobal:cbv:mda#itemExpirationDate">2017-10-
31</attribute>
              </VocabularyElement>
              <!-- Product B -->
              <VocabularyElement id="urn:epc:idpat:sgtin:030000.0000001.*">
                <attribute
id="urn:epcglobal:cbv:mda#additionalTradeItemIdentification">00000000001</attribute>
                <attribute
id="urn:epcglobal:cbv:mda#additionalTradeItemIdentificationTypeCode">FDA_NDC_11</attribute>
                <attribute
id="urn:epcglobal:cbv:mda#regulatedProductName">Epcistra</attribute>
                <attribute
id="urn:epcglobal:cbv:mda#manufacturerOfTradeItemPartyName">GS1 Pharma LLC</attribute>
                <attribute id="urn:epcglobal:cbv:mda#dosageFormType">PILL</attribute>
                <attribute
id="urn:epcglobal:cbv:mda#strengthDescription">100mg</attribute>
              </VocabularyElement>
            </VocabularyElementList>
          </Vocabulary>
        </VocabularyList>
      </EPCISMasterData>
    </extension>
  </EPCISHeader>
</EPCISDocument>
```



```

                    <attribute id="urn:epcglobal:cbv:mda#netContentDescription">500
pills</attribute>
                </VocabularyElement>
            </VocabularyElementList>
        </Vocabulary>
        <Vocabulary type="urn:epcglobal:epcis:vtype:Location">
            <VocabularyElementList>
                <VocabularyElement id="urn:epc:id:sgln:030000.000000.0">
                    <attribute id="urn:epcglobal:cbv:mda#name">GS1 Pharma LLC</attribute>
                    <attribute id="urn:epcglobal:cbv:mda#streetAddressOne">1295 S George
Ave</attribute>
                    <attribute id="urn:epcglobal:cbv:mda#streetAddressTwo">Room
378</attribute>
                    <attribute id="urn:epcglobal:cbv:mda#city">Washington</attribute>
                    <attribute id="urn:epcglobal:cbv:mda#state">DC</attribute>
                    <attribute id="urn:epcglobal:cbv:mda#postalCode">12345-
6789</attribute>
                    <attribute id="urn:epcglobal:cbv:mda#countryCode">US</attribute>
                </VocabularyElement>
            <VocabularyElement id="urn:epc:id:sgln:0614141.00000.0">
                <attribute id="urn:epcglobal:cbv:mda#name">GS1 Drug Distro
LLC</attribute>
                <attribute id="urn:epcglobal:cbv:mda#streetAddressOne">230 Park Ave
S</attribute>
                <attribute id="urn:epcglobal:cbv:mda#city">New York</attribute>
                <attribute id="urn:epcglobal:cbv:mda#state">NY</attribute>
                <attribute id="urn:epcglobal:cbv:mda#postalCode">10003-
1502</attribute>
                <attribute id="urn:epcglobal:cbv:mda#countryCode">US</attribute>
            </VocabularyElement>
        </VocabularyElementList>
    </Vocabulary>
</VocabularyList>
</EPCISMasterData>
</extension>
<gslushc:dscsaTransactionStatement>
    <gslushc:affirmTransactionStatement>true</gslushc:affirmTransactionStatement>
    <gslushc:legalNotice>Seller has complied with each applicable subsection of FDCA Sec.
581 (27) (A) - (G).</gslushc:legalNotice>
</gslushc:dscsaTransactionStatement>
</EPCISHeader>
<EPCISBody>
    <EventList>
        <!-- Transaction Information (TI) -->
        <ObjectEvent>
            <eventTime>2014-04-01T10:11:12Z</eventTime>
            <eventTimeZoneOffset>-05:00</eventTimeZoneOffset>
            <epcList/>
            <action>OBSERVE</action>
            <bizStep>urn:epcglobal:cbv:bizstep:shipping</bizStep>
            <disposition>urn:epcglobal:cbv:disp:in_transit</disposition>
            <readPoint>
                <id>urn:epc:id:sgln:030000.000000.0</id>
            </readPoint>
            <extension>
                <quantityList>
                    <!-- In this example, the EPCIS quantityElement data structure contains the
lgtin for the lowest saleable unit (LSU) and the quantity value is given in terms of LSUs. For
this example scenario, each ordered case contains 12 LSUs. Hence, the quantity value will be
computed by multiplying the order case quantity with 12 LSUs. -->
                    <quantityElement>

```

```

        <!-- Incorrect Product -->
        <epcClass>urn:epc:class:lgtin:030000.0000001.L1</epcClass>
        <quantity>120</quantity>
      </quantityElement>
    </quantityList>
    <sourceList>
      <source
type="urn:epcglobal:cbv:sdt:owning_party">urn:epc:id:sgln:030000.000000.0</source>
    </sourceList>
    <destinationList>
      <destination
type="urn:epcglobal:cbv:sdt:owning_party">urn:epc:id:sgln:0614141.00000.0</destination>
    </destinationList>
  </extension>
</ObjectEvent>
</EventList>
</EPCISBody>
</epcis:EPCISDocument>

```

## 12.7.2 Sample XML: Seller Corrects Shipment Data

Reference File: <https://resources.gs1us.org/Portals/0/xml/LotException-IncorrectProduct-SellerCorrectsShipmentData.xml>

```

<?xml version="1.0" encoding="UTF-8"?>
<!-- Lot Exception: INCORRECT PRODUCT DATA - Seller corrects shipment data -->
<!-- Seller investigates discrepancy and resolves issue by generating voidShipping event for
the previously generated shipping event with the incorrect Product information -->
<epcis:EPCISDocument xmlns:cbvmda="urn:epcglobal:cbv:mda"
xmlns:sbdh="http://www.unece.org/cefact/namespaces/StandardBusinessDocumentHeader"
xmlns:gslushc="http://epcis.gs1us.org/hc/ns" xmlns:epcis="urn:epcglobal:epcis:xsd:1"
schemaVersion="1.2" xsi:schemaLocation="urn:epcglobal:epcis:xsd:1 EPCglobal-epcis-1_2.xsd"
xmlns:xsi="http://www.w3.org/2001/XMLSchema-instance" creationDate="2014-04-03T15:14:27.574-
04:00">
  <EPCISHeader>
    <sbdh:StandardBusinessDocumentHeader>
      <sbdh:HeaderVersion>1.0</sbdh:HeaderVersion>
      <sbdh:Sender>
        <sbdh:Identifier
Authority="SGLN">urn:epc:id:sgln:030000.000000.0</sbdh:Identifier>
      </sbdh:Sender>
      <sbdh:Receiver>
        <sbdh:Identifier
Authority="SGLN">urn:epc:id:sgln:030000.000001.0</sbdh:Identifier>
      </sbdh:Receiver>
      <sbdh:DocumentIdentification>
        <sbdh:Standard>EPCglobal</sbdh:Standard>
        <sbdh:TypeVersion>1.0</sbdh:TypeVersion>
        <sbdh:InstanceIdentifier>1234567865</sbdh:InstanceIdentifier>
        <sbdh:Type>Events</sbdh:Type>
        <sbdh:CreationDateAndTime>2014-04-03T15:14:27.574-04:00</sbdh:CreationDateAndTime>
      </sbdh:DocumentIdentification>
    </sbdh:StandardBusinessDocumentHeader>
    <extension>
      <EPCISMasterData>
        <VocabularyList>
          <Vocabulary type="urn:epcglobal:epcis:vtype:EPCClass">
            <VocabularyElementList>
              <VocabularyElement id="urn:epc:class:lgtin:030000.0000001.L1">

```

```

        <attribute id="urn:epcglobal:cbv:mda#itemExpirationDate">2017-10-
31</attribute>
        </VocabularyElement>
        <VocabularyElement id="urn:epc:idpat:sgtin:030000.0000001.*">
        <attribute
id="urn:epcglobal:cbv:mda#additionalTradeItemIdentification">00000000001</attribute>
        <attribute
id="urn:epcglobal:cbv:mda#additionalTradeItemIdentificationTypeCode">FDA_NDC_11</attribute>
        <attribute
id="urn:epcglobal:cbv:mda#regulatedProductName">Epcistra</attribute>
        <attribute
id="urn:epcglobal:cbv:mda#manufacturerOfTradeItemPartyName">GS1 Pharma LLC</attribute>
        <attribute id="urn:epcglobal:cbv:mda#dosageFormType">PILL</attribute>
        <attribute
id="urn:epcglobal:cbv:mda#strengthDescription">100mg</attribute>
        <attribute id="urn:epcglobal:cbv:mda#netContentDescription">500
pills</attribute>
        </VocabularyElement>
        </VocabularyElementList>
    </Vocabulary>
    <Vocabulary type="urn:epcglobal:epcis:vtype:Location">
        <VocabularyElementList>
            <VocabularyElement id="urn:epc:id:sgln:030000.000000.0">
                <attribute id="urn:epcglobal:cbv:mda#name">GS1 Pharma LLC</attribute>
                <attribute id="urn:epcglobal:cbv:mda#streetAddressOne">1295 S George
Ave</attribute>
                <attribute id="urn:epcglobal:cbv:mda#streetAddressTwo">Room
378</attribute>
                <attribute id="urn:epcglobal:cbv:mda#city">Washington</attribute>
                <attribute id="urn:epcglobal:cbv:mda#state">DC</attribute>
                <attribute id="urn:epcglobal:cbv:mda#postalCode">12345-
6789</attribute>
                <attribute id="urn:epcglobal:cbv:mda#countryCode">US</attribute>
            </VocabularyElement>
            <!-- Buyer B -->
            <VocabularyElement id="urn:epc:id:sgln:0614141.00000.0">
                <attribute id="urn:epcglobal:cbv:mda#name">GS1 Drug Distro
LLC</attribute>
                <attribute id="urn:epcglobal:cbv:mda#streetAddressOne">230 Park Ave
S</attribute>
                <attribute id="urn:epcglobal:cbv:mda#city">New York</attribute>
                <attribute id="urn:epcglobal:cbv:mda#state">NY</attribute>
                <attribute id="urn:epcglobal:cbv:mda#postalCode">10003-
1502</attribute>
                <attribute id="urn:epcglobal:cbv:mda#countryCode">US</attribute>
            </VocabularyElement>
        </VocabularyElementList>
    </Vocabulary>
</VocabularyList>
</EPCISMasterData>
</extension>
</EPCISHeader>
<EPCISBody>
    <EventList>
        <ObjectEvent>
            <eventTime>2014-04-03T10:11:12Z</eventTime>
            <eventTimeZoneOffset>-05:00</eventTimeZoneOffset>
            <epcList/>
            <action>OBSERVE</action>
            <bizStep>urn:epcglobal:cbv:bizstep:void_shipping</bizStep>
            <disposition>urn:epcglobal:cbv:disp:in_progress</disposition>
        </ObjectEvent>
    </EventList>
</EPCISBody>
</EPCISHeader>
</EPCISMasterData>
</extension>
</EPCISHeader>
</EPCISBody>
</EventList>
</ObjectEvent>
<eventTime>2014-04-03T10:11:12Z</eventTime>
<eventTimeZoneOffset>-05:00</eventTimeZoneOffset>
<epcList/>
<action>OBSERVE</action>
<bizStep>urn:epcglobal:cbv:bizstep:void_shipping</bizStep>
<disposition>urn:epcglobal:cbv:disp:in_progress</disposition>

```

```

<readPoint>
  <id>urn:epc:id:sgln:030000.000000.0</id>
</readPoint>
<extension>
  <quantityList>
    <!-- In this example, the EPCIS quantityElement data structure contains the
lgtin for the lowest saleable unit (LSU) and the quantity value is given in terms of LSUs. For
this example scenario, each ordered case contains 12 LSUs. Hence, the quantity value will be
computed by multiplying the order case quantity with 12 LSUs. -->
    <quantityElement>
      <!-- Incorrect Product information -->
      <epcClass>urn:epc:class:lgtin:030000.0000001.L1</epcClass>
      <quantity>120</quantity>
    </quantityElement>
  </quantityList>
  <sourceList>
    <source
type="urn:epcglobal:cbv:sdt:owning_party">urn:epc:id:sgln:030000.000000.0</source>
    </sourceList>
  <destinationList>
    <destination
type="urn:epcglobal:cbv:sdt:owning_party">urn:epc:id:sgln:0614141.00000.0</destination>
    </destinationList>
  </extension>
</ObjectEvent>
</EventList>
</EPCISBody>
</epcis:EPCISDocument>

```

### 12.7.3 Sample XML: Exchange2 - Seller → Buyer

Reference File: <https://resources.gs1us.org/Portals/0/xml/LotException-IncorrectProduct-SellerExchange2.xml>

```

<?xml version="1.0" encoding="UTF-8"?>
<!-- Lot Exception: INCORRECT PRODUCT DATA - Exchange2: Seller -> Buyer-->
<!-- Seller generates shipping event with correct Product information. -->
<epcis:EPCISDocument xmlns:cbvmda="urn:epcglobal:cbv:mda"
xmlns:sbdh="http://www.unece.org/cefact/namespaces/StandardBusinessDocumentHeader"
xmlns:gslushc="http://epcis.gs1us.org/hc/ns" xmlns:epcis="urn:epcglobal:epcis:xsd:1"
schemaVersion="1.2" xsi:schemaLocation="urn:epcglobal:epcis:xsd:1 EPCglobal-epcis-1_2.xsd"
xmlns:xsi="http://www.w3.org/2001/XMLSchema-instance" creationDate="2014-04-04T15:14:27.574-
04:00">
  <EPCISHeader>
    <sbdh:StandardBusinessDocumentHeader>
      <sbdh:HeaderVersion>1.0</sbdh:HeaderVersion>
      <sbdh:Sender>
        <sbdh:Identifier
Authority="SGLN">urn:epc:id:sgln:030000.000000.0</sbdh:Identifier>
      </sbdh:Sender>
      <sbdh:Receiver>
        <sbdh:Identifier
Authority="SGLN">urn:epc:id:sgln:0614141.00000.0</sbdh:Identifier>
      </sbdh:Receiver>
      <sbdh:DocumentIdentification>
        <sbdh:Standard>EPCglobal</sbdh:Standard>
        <sbdh:TypeVersion>1.0</sbdh:TypeVersion>
        <sbdh:InstanceIdentifier>1234567866</sbdh:InstanceIdentifier>
        <sbdh:Type>Events</sbdh:Type>
        <sbdh:CreationDateAndTime>2014-04-04T15:14:27.574-04:00</sbdh:CreationDateAndTime>
      </sbdh:DocumentIdentification>
    </sbdh:StandardBusinessDocumentHeader>
  </EPCISHeader>
</epcis:EPCISDocument>

```

```

</sbdh:DocumentIdentification>
</sbdh:StandardBusinessDocumentHeader>
<extension>
  <EPCISMasterData>
    <VocabularyList>
      <Vocabulary type="urn:epcglobal:epcis:vtype:EPCClass">
        <VocabularyElementList>
          <!-- Product A -->
          <VocabularyElement id="urn:epc:class:lgtn:030000.0000032.L8">
            <attribute id="urn:epcglobal:cbv:mda#itemExpirationDate">2017-10-
31</attribute>

            </VocabularyElement>
          <!-- Product A -->
          <VocabularyElement id="urn:epc:idpat:sgtin:030000.0000032.*">
            <attribute
id="urn:epcglobal:cbv:mda#additionalTradeItemIdentification">00000000032</attribute>
            <attribute
id="urn:epcglobal:cbv:mda#additionalTradeItemIdentificationTypeCode">FDA_NDC_11</attribute>
            <attribute
id="urn:epcglobal:cbv:mda#regulatedProductName">Epcistra</attribute>
            <attribute
id="urn:epcglobal:cbv:mda#manufacturerOfTradeItemPartyName">GS1 Pharma LLC</attribute>
            <attribute id="urn:epcglobal:cbv:mda#dosageFormType">PILL</attribute>
            <attribute
id="urn:epcglobal:cbv:mda#strengthDescription">200mg</attribute>
            <attribute id="urn:epcglobal:cbv:mda#netContentDescription">300
pills</attribute>

          </VocabularyElement>
        </VocabularyElementList>
      </Vocabulary>
      <Vocabulary type="urn:epcglobal:epcis:vtype:Location">
        <VocabularyElementList>
          <VocabularyElement id="urn:epc:id:sgln:030000.000000.0">
            <attribute id="urn:epcglobal:cbv:mda#name">GS1 Pharma LLC</attribute>
            <attribute id="urn:epcglobal:cbv:mda#streetAddressOne">1295 S George
Ave</attribute>
            <attribute id="urn:epcglobal:cbv:mda#streetAddressTwo">Room
378</attribute>

            <attribute id="urn:epcglobal:cbv:mda#city">Washington</attribute>
            <attribute id="urn:epcglobal:cbv:mda#state">DC</attribute>
            <attribute id="urn:epcglobal:cbv:mda#postalCode">12345-
6789</attribute>

            <attribute id="urn:epcglobal:cbv:mda#countryCode">US</attribute>
          </VocabularyElement>
          <VocabularyElement id="urn:epc:id:sgln:0614141.00000.0">
            <attribute id="urn:epcglobal:cbv:mda#name">GS1 Drug Distro
LLC</attribute>
            <attribute id="urn:epcglobal:cbv:mda#streetAddressOne">230 Park Ave
S</attribute>

            <attribute id="urn:epcglobal:cbv:mda#city">New York</attribute>
            <attribute id="urn:epcglobal:cbv:mda#state">NY</attribute>
            <attribute id="urn:epcglobal:cbv:mda#postalCode">10003-
1502</attribute>

            <attribute id="urn:epcglobal:cbv:mda#countryCode">US</attribute>
          </VocabularyElement>
        </VocabularyElementList>
      </Vocabulary>
    </VocabularyList>
  </EPCISMasterData>
</extension>
<gslushc:dscsaTransactionStatement>

```

```

    <gslushc:affirmTransactionStatement>true</gslushc:affirmTransactionStatement>
    <gslushc:legalNotice>Seller has complied with each applicable subsection of FDCA Sec.
581 (27) (A) - (G).</gslushc:legalNotice>
  </gslushc:dscsaTransactionStatement>
</EPCISHeader>
<EPCISBody>
  <EventList>
    <!-- Transaction Information (TI) -->
    <ObjectEvent>
      <eventTime>2014-04-01T10:11:12Z</eventTime>
      <eventTimeZoneOffset>-05:00</eventTimeZoneOffset>
      <epcList/>
      <action>OBSERVE</action>
      <bizStep>urn:epcglobal:cbv:bizstep:shipping</bizStep>
      <disposition>urn:epcglobal:cbv:disp:in_transit</disposition>
      <readPoint>
        <id>urn:epc:id:sgln:030000.000000.0</id>
      </readPoint>
      <extension>
        <quantityList>
          <!-- In this example, the EPCIS quantityElement data structure contains the
lgtin for the lowest saleable unit (LSU) and the quantity value is given in terms of LSUs. For
this example scenario, each ordered case contains 12 LSUs. Hence, the quantity value will be
computed by multiplying the order case quantity with 12 LSUs. -->
          <quantityElement>
            <!-- Correct Product Information -->
            <epcClass>urn:epc:class:lgtin:030000.0000032.L8</epcClass>
            <quantity>120</quantity>
          </quantityElement>
        </quantityList>
        <sourceList>
          <source
type="urn:epcglobal:cbv:sdt:owning_party">urn:epc:id:sgln:030000.000000.0</source>
        </sourceList>
        <destinationList>
          <destination
type="urn:epcglobal:cbv:sdt:owning_party">urn:epc:id:sgln:0614141.00000.0</destination>
        </destinationList>
      </extension>
    </ObjectEvent>
  </EventList>
</EPCISBody>
</epcis:EPCISDocument>

```

## 12.7.4 Sample XML: Buyer Receives Product

Reference File: <https://resources.gs1us.org/Portals/0/xml/LotException-IncorrectProduct-BuyerReceives.xml>

```

<?xml version="1.0" encoding="UTF-8"?>
<!-- Lot Exception: INCORRECT PRODUCT DATA - Buyer Receives Product-->
<!--Buyer receives 10 cases with supporting DSCSA data -->
<epcis:EPCISDocument xmlns:cbvmda="urn:epcglobal:cbv:mda"
xmlns:sbdh="http://www.unece.org/cefact/namespaces/StandardBusinessDocumentHeader"
xmlns:gslushc="http://epcis.gs1us.org/hc/ns" xmlns:epcis="urn:epcglobal:epcis:xsd:1"
schemaVersion="1.2" xsi:schemaLocation="urn:epcglobal:epcis:xsd:1 EPCglobal-epcis-1_2.xsd"
xmlns:xsi="http://www.w3.org/2001/XMLSchema-instance" creationDate="2014-04-05T15:14:27.574-
04:00">
  <EPCISHeader>
    <sbdh:StandardBusinessDocumentHeader>

```

```

    <sbdh:HeaderVersion>1.0</sbdh:HeaderVersion>
    <sbdh:Sender>
      <sbdh:Identifier
Authority="SGLN">urn:epc:id:sgln:0614141.00000.0</sbdh:Identifier>
    </sbdh:Sender>
    <sbdh:Receiver>
      <sbdh:Identifier
Authority="SGLN">urn:epc:id:sgln:0614141.11111.0</sbdh:Identifier>
    </sbdh:Receiver>
    <sbdh:DocumentIdentification>
      <sbdh:Standard>EPCglobal</sbdh:Standard>
      <sbdh:TypeVersion>1.0</sbdh:TypeVersion>
      <sbdh:InstanceIdentifier>1234567867</sbdh:InstanceIdentifier>
      <sbdh:Type>Events</sbdh:Type>
      <sbdh:CreationDateAndTime>2014-04-05T15:14:27.574-04:00</sbdh:CreationDateAndTime>
    </sbdh:DocumentIdentification>
  </sbdh:StandardBusinessDocumentHeader>
  <extension>
    <EPCISMasterData>
      <VocabularyList>
        <Vocabulary type="urn:epcglobal:epcis:vtype:EPCClass">
          <VocabularyElementList>
            <!-- Product A -->
            <VocabularyElement id="urn:epc:class:lgtin:030000.0000032.L8">
              <attribute id="urn:epcglobal:cbv:mda#itemExpirationDate">2017-10-
31</attribute>
            </VocabularyElement>
            <!-- Product A -->
            <VocabularyElement id="urn:epc:idpat:sgtin:030000.0000032.*">
              <attribute
id="urn:epcglobal:cbv:mda#additionalTradeItemIdentification">00000000032</attribute>
              <attribute
id="urn:epcglobal:cbv:mda#additionalTradeItemIdentificationTypeCode">FDA_NDC_11</attribute>
              <attribute
id="urn:epcglobal:cbv:mda#regulatedProductName">Epcistra</attribute>
              <attribute
id="urn:epcglobal:cbv:mda#manufacturerOfTradeItemPartyName">GS1 Pharma LLC</attribute>
              <attribute id="urn:epcglobal:cbv:mda#dosageFormType">PILL</attribute>
              <attribute
id="urn:epcglobal:cbv:mda#strengthDescription">200mg</attribute>
              <attribute id="urn:epcglobal:cbv:mda#netContentDescription">300
pills</attribute>
            </VocabularyElement>
          </VocabularyElementList>
        </Vocabulary>
        <Vocabulary type="urn:epcglobal:epcis:vtype:Location">
          <VocabularyElementList>
            <VocabularyElement id="urn:epc:id:sgln:030000.000000.0">
              <attribute id="urn:epcglobal:cbv:mda#name">GS1 Pharma LLC</attribute>
              <attribute id="urn:epcglobal:cbv:mda#streetAddressOne">1295 S George
Ave</attribute>
              <attribute id="urn:epcglobal:cbv:mda#streetAddressTwo">Room
378</attribute>
              <attribute id="urn:epcglobal:cbv:mda#city">Washington</attribute>
              <attribute id="urn:epcglobal:cbv:mda#state">DC</attribute>
              <attribute id="urn:epcglobal:cbv:mda#postalCode">12345-
6789</attribute>
              <attribute id="urn:epcglobal:cbv:mda#countryCode">US</attribute>
            </VocabularyElement>
          </VocabularyElementList>
        </Vocabulary>
      </VocabularyList>
    </EPCISMasterData>
  </extension>

```



```

        <attribute id="urn:epcglobal:cbv:mda#name">GS1 Drug Distro
LLC</attribute>
        <attribute id="urn:epcglobal:cbv:mda#streetAddressOne">230 Park Ave
S</attribute>
        <attribute id="urn:epcglobal:cbv:mda#city">New York</attribute>
        <attribute id="urn:epcglobal:cbv:mda#state">NY</attribute>
        <attribute id="urn:epcglobal:cbv:mda#postalCode">10003-
1502</attribute>
        <attribute id="urn:epcglobal:cbv:mda#countryCode">US</attribute>
    </VocabularyElement>
</VocabularyElementList>
</Vocabulary>
</VocabularyList>
</EPCISMasterData>
</extension>
</EPCISHeader>
<EPCISBody>
    <EventList>
        <ObjectEvent>
            <eventTime>2014-04-05T10:11:12Z</eventTime>
            <eventTimeZoneOffset>-05:00</eventTimeZoneOffset>
            <epcList/>
            <action>OBSERVE</action>
            <bizStep>urn:epcglobal:cbv:bizstep:receiving</bizStep>
            <disposition>urn:epcglobal:cbv:disp:in_progress</disposition>
            <readPoint>
                <id>urn:epc:id:sgln:0614141.00000.0</id>
            </readPoint>
            <extension>
                <quantityList>
                    <!-- In this example, the EPCIS quantityElement data structure contains the
lgtin for the lowest saleable unit (LSU) and the quantity value is given in terms of LSUs. For
this example scenario,each ordered case contains 12 LSUs. Hence, the quantity value will be
computed by multiplying the order case quantity with 12 LSUs. -->
                    <quantityElement>
                        <!-- Correct Product Information -->
                        <epcClass>urn:epc:class:lgtin:030000.0000032.L8</epcClass>
                        <quantity>120</quantity>
                    </quantityElement>
                </quantityList>
                <sourceList>
                    <source
type="urn:epcglobal:cbv:sdt:owning_party">urn:epc:id:sgln:030000.000000.0</source>
                </sourceList>
                <destinationList>
                    <destination
type="urn:epcglobal:cbv:sdt:owning_party">urn:epc:id:sgln:0614141.00000.0</destination>
                </destinationList>
            </extension>
        </ObjectEvent>
    </EventList>
</EPCISBody>
</epcis:EPCISDocument>

```



## 12.8 EPCIS Data Not Received By Buyer

### 12.8.1 Sample XML: Exchange1 - Seller → Buyer

Reference File: <https://resources.gs1us.org/Portals/0/xml/LotException-EPCISDataNotReceivedByBuyer-SellerExchange1.xml>

```
<?xml version="1.0" encoding="UTF-8"?>
<!-- Lot Exception: EPCIS DATA NOT RECEIVED BY BUYER - Exchange1: Seller -> Buyer-->
<!-- Seller ships correct shipment to the Buyer; however, the EPCIS XML for the DSCSA data does not arrive.
      Seller issues a new shipping event with original shipping dates -->
<epcis:EPCISDocument xmlns:cbvmda="urn:epcglobal:cbv:mda"
xmlns:sbdh="http://www.unece.org/cefact/namespaces/StandardBusinessDocumentHeader"
xmlns:gslushc="http://epcis.gs1us.org/hc/ns" xmlns:epcis="urn:epcglobal:epcis:xsd:1"
schemaVersion="1.2" xsi:schemaLocation="urn:epcglobal:epcis:xsd:1 EPCglobal-epcis-1_2.xsd"
xmlns:xsi="http://www.w3.org/2001/XMLSchema-instance" creationDate="2014-04-01T15:14:27.574-04:00">
  <EPCISHeader>
    <sbdh:StandardBusinessDocumentHeader>
      <sbdh:HeaderVersion>1.0</sbdh:HeaderVersion>
      <sbdh:Sender>
        <sbdh:Identifier
Authority="SGLN">urn:epc:id:sgln:030000.000000.0</sbdh:Identifier>
        </sbdh:Sender>
        <sbdh:Receiver>
          <sbdh:Identifier
Authority="SGLN">urn:epc:id:sgln:0614141.000000.0</sbdh:Identifier>
        </sbdh:Receiver>
        <sbdh:DocumentIdentification>
          <sbdh:Standard>EPCglobal</sbdh:Standard>
          <sbdh:TypeVersion>1.0</sbdh:TypeVersion>
          <sbdh:InstanceIdentifier>1234567868</sbdh:InstanceIdentifier>
          <sbdh:Type>Events</sbdh:Type>
          <sbdh:CreationDateAndTime>2014-04-01T15:14:27.574-04:00</sbdh:CreationDateAndTime>
        </sbdh:DocumentIdentification>
      </sbdh:StandardBusinessDocumentHeader>
      <extension>
        <EPCISMasterData>
          <VocabularyList>
            <Vocabulary type="urn:epcglobal:epcis:vtype:EPCClass">
              <VocabularyElementList>
                <VocabularyElement id="urn:epc:class:lgtin:030000.0000001.L1">
                  <attribute id="urn:epcglobal:cbv:mda#itemExpirationDate">2017-10-31</attribute>
                </VocabularyElement>
                <VocabularyElement id="urn:epc:idpat:sgtin:030000.0000001.*">
                  <attribute
id="urn:epcglobal:cbv:mda#additionalTradeItemIdentification">0000000001</attribute>
                  <attribute
id="urn:epcglobal:cbv:mda#additionalTradeItemIdentificationTypeCode">FDA_NDC_11</attribute>
                  <attribute
id="urn:epcglobal:cbv:mda#regulatedProductName">Epcistra</attribute>
                  <attribute
id="urn:epcglobal:cbv:mda#manufacturerOfTradeItemPartyName">GS1 Pharma LLC</attribute>
                  <attribute id="urn:epcglobal:cbv:mda#dosageFormType">PILL</attribute>
                  <attribute
id="urn:epcglobal:cbv:mda#strengthDescription">100mg</attribute>
                  <attribute id="urn:epcglobal:cbv:mda#netContentDescription">500 pills</attribute>
                </VocabularyElement>
              </VocabularyElementList>
            </Vocabulary>
          </EPCISMasterData>
        </extension>
      </EPCISHeader>
    </sbdh:StandardBusinessDocumentHeader>
  </epcis:EPCISDocument>
```

```

        </VocabularyElement>
      </VocabularyElementList>
    </Vocabulary>
    <Vocabulary type="urn:epcglobal:epcis:vtype:Location">
      <VocabularyElementList>
        <VocabularyElement id="urn:epc:id:sgln:030000.000000.0">
          <attribute id="urn:epcglobal:cbv:mda#name">GS1 Pharma LLC</attribute>
          <attribute id="urn:epcglobal:cbv:mda#streetAddressOne">1295 S George
Ave</attribute>
          <attribute id="urn:epcglobal:cbv:mda#streetAddressTwo">Room
378</attribute>
          <attribute id="urn:epcglobal:cbv:mda#city">Washington</attribute>
          <attribute id="urn:epcglobal:cbv:mda#state">DC</attribute>
          <attribute id="urn:epcglobal:cbv:mda#postalCode">12345-
6789</attribute>
          <attribute id="urn:epcglobal:cbv:mda#countryCode">US</attribute>
        </VocabularyElement>
        <VocabularyElement id="urn:epc:id:sgln:0614141.00000.0">
          <attribute id="urn:epcglobal:cbv:mda#name">GS1 Drug Distro
LLC</attribute>
          <attribute id="urn:epcglobal:cbv:mda#streetAddressOne">230 Park Ave
S</attribute>
          <attribute id="urn:epcglobal:cbv:mda#city">New York</attribute>
          <attribute id="urn:epcglobal:cbv:mda#state">NY</attribute>
          <attribute id="urn:epcglobal:cbv:mda#postalCode">10003-
1502</attribute>
          <attribute id="urn:epcglobal:cbv:mda#countryCode">US</attribute>
        </VocabularyElement>
      </VocabularyElementList>
    </Vocabulary>
  </VocabularyList>
</EPCISMasterData>
</extension>
<gslushc:dscsaTransactionStatement>
  <gslushc:affirmTransactionStatement>true</gslushc:affirmTransactionStatement>
  <gslushc:legalNotice>Seller has complied with each applicable subsection of FDCA Sec.
581 (27) (A) - (G).</gslushc:legalNotice>
</gslushc:dscsaTransactionStatement>
</EPCISHeader>
<EPCISBody>
  <EventList>
    <!-- Transaction Information (TI) -->
    <ObjectEvent>
      <eventTime>2014-04-01T10:11:12Z</eventTime>
      <eventTimeZoneOffset>-05:00</eventTimeZoneOffset>
      <epcList/>
      <action>OBSERVE</action>
      <bizStep>urn:epcglobal:cbv:bizstep:shipping</bizStep>
      <disposition>urn:epcglobal:cbv:disp:in_transit</disposition>
      <readPoint>
        <id>urn:epc:id:sgln:030000.000000.0</id>
      </readPoint>
      <extension>
        <quantityList>
          <!-- In this example, the EPCIS quantityElement data structure contains the
lgtin for the lowest saleable unit (LSU) and the quantity value is given in terms of LSUs. For
this example scenario, each ordered case contains 12 LSUs. Hence, the quantity value will be
computed by multiplying the order case quantity with 12 LSUs. -->
          <quantityElement>
            <epcClass>urn:epc:class:lgtin:030000.0000001.L1</epcClass>
            <quantity>120</quantity>
          </quantityElement>
        </quantityList>
      </extension>
    </ObjectEvent>
  </EventList>
</EPCISBody>
</EPCISMessage>

```

```

        </quantityElement>
    </quantityList>
    <sourceList>
        <source
type="urn:epcglobal:cbv:sdt:owning_party">urn:epc:id:sgln:030000.000000.0</source>
        </sourceList>
    <destinationList>
        <destination
type="urn:epcglobal:cbv:sdt:owning_party">urn:epc:id:sgln:0614141.00000.0</destination>
        </destinationList>
    </extension>
</ObjectEvent>
</EventList>
</EPCISBody>
</epcis:EPCISDocument>

```

## 12.8.2 Sample XML: Buyer Receives Product

Reference File: <https://resources.gs1us.org/Portals/0/xml/LotException-EPCISDataNotReceivedByBuyer-BuyerReceives.xml>

```

<?xml version="1.0" encoding="UTF-8"?>
<!-- Lot Exception: EPCIS DATA NOT RECEIVED BY BUYER - Buyer Receives Product -->
<!-- Buyer receives 10 cases with supporting DSCSA data -->
<epcis:EPCISDocument xmlns:cbvmda="urn:epcglobal:cbv:mda"
xmlns:sbdh="http://www.unece.org/cefact/namespaces/StandardBusinessDocumentHeader"
xmlns:gslushc="http://epcis.gs1us.org/hc/ns" xmlns:epcis="urn:epcglobal:epcis:xsd:1"
schemaVersion="1.2" xsi:schemaLocation="urn:epcglobal:epcis:xsd:1 EPCglobal-epcis-1_2.xsd"
xmlns:xsi="http://www.w3.org/2001/XMLSchema-instance" creationDate="2014-04-02T15:14:27.574-
04:00">
    <EPCISHeader>
        <sbdh:StandardBusinessDocumentHeader>
            <sbdh:HeaderVersion>1.0</sbdh:HeaderVersion>
            <sbdh:Sender>
                <sbdh:Identifier
Authority="SGLN">urn:epc:id:sgln:0614141.00000.0</sbdh:Identifier>
            </sbdh:Sender>
            <sbdh:Receiver>
                <sbdh:Identifier
Authority="SGLN">urn:epc:id:sgln:0614141.11111.0</sbdh:Identifier>
            </sbdh:Receiver>
            <sbdh:DocumentIdentification>
                <sbdh:Standard>EPCglobal</sbdh:Standard>
                <sbdh:TypeVersion>1.0</sbdh:TypeVersion>
                <sbdh:InstanceIdentifier>1234567869</sbdh:InstanceIdentifier>
                <sbdh:Type>Events</sbdh:Type>
                <sbdh:CreationDateAndTime>2014-04-02T15:14:27.574-04:00</sbdh:CreationDateAndTime>
            </sbdh:DocumentIdentification>
        </sbdh:StandardBusinessDocumentHeader>
        <extension>
            <EPCISMasterData>
                <VocabularyList>
                    <Vocabulary type="urn:epcglobal:epcis:vtype:EPCClass">
                        <VocabularyElementList>
                            <VocabularyElement id="urn:epc:class:lgtn:030000.0000001.L1">
                                <attribute id="urn:epcglobal:cbv:mda:itemExpirationDate">2017-10-
31</attribute>
                            </VocabularyElement>
                            <VocabularyElement id="urn:epc:idpat:sgtin:030000.0000001.*">

```

```

        <attribute
id="urn:epcglobal:cbv:mda#additionalTradeItemIdentification">0000000001</attribute>
        <attribute
id="urn:epcglobal:cbv:mda#additionalTradeItemIdentificationTypeCode">FDA_NDC_11</attribute>
        <attribute
id="urn:epcglobal:cbv:mda#regulatedProductName">Epcistra</attribute>
        <attribute
id="urn:epcglobal:cbv:mda#manufacturerOfTradeItemPartyName">GS1 Pharma LLC</attribute>
        <attribute id="urn:epcglobal:cbv:mda#dosageFormType">PILL</attribute>
        <attribute
id="urn:epcglobal:cbv:mda#strengthDescription">100mg</attribute>
        <attribute id="urn:epcglobal:cbv:mda#netContentDescription">500
pills</attribute>
    </VocabularyElement>
</VocabularyElementList>
</Vocabulary>
<Vocabulary type="urn:epcglobal:epcis:vtype:Location">
    <VocabularyElementList>
        <VocabularyElement id="urn:epc:id:sgln:030000.000000.0">
            <attribute id="urn:epcglobal:cbv:mda#name">GS1 Pharma LLC</attribute>
            <attribute id="urn:epcglobal:cbv:mda#streetAddressOne">1295 S George
Ave</attribute>
            <attribute id="urn:epcglobal:cbv:mda#streetAddressTwo">Room
378</attribute>
            <attribute id="urn:epcglobal:cbv:mda#city">Washington</attribute>
            <attribute id="urn:epcglobal:cbv:mda#state">DC</attribute>
            <attribute id="urn:epcglobal:cbv:mda#postalCode">12345-
6789</attribute>
            <attribute id="urn:epcglobal:cbv:mda#countryCode">US</attribute>
        </VocabularyElement>
        <VocabularyElement id="urn:epc:id:sgln:0614141.00000.0">
            <attribute id="urn:epcglobal:cbv:mda#name">GS1 Drug Distro
LLC</attribute>
            <attribute id="urn:epcglobal:cbv:mda#streetAddressOne">230 Park Ave
S</attribute>
            <attribute id="urn:epcglobal:cbv:mda#city">New York</attribute>
            <attribute id="urn:epcglobal:cbv:mda#state">NY</attribute>
            <attribute id="urn:epcglobal:cbv:mda#postalCode">10003-
1502</attribute>
            <attribute id="urn:epcglobal:cbv:mda#countryCode">US</attribute>
        </VocabularyElement>
    </VocabularyElementList>
</Vocabulary>
</VocabularyList>
</EPCISMasterData>
</extension>
</EPCISHeader>
<EPCISBody>
    <EventList>
        <ObjectEvent>
            <eventTime>2014-04-02T10:11:12Z</eventTime>
            <eventTimeZoneOffset>-05:00</eventTimeZoneOffset>
            <epcList/>
            <action>OBSERVE</action>
            <bizStep>urn:epcglobal:cbv:bizstep:receiving</bizStep>
            <disposition>urn:epcglobal:cbv:disp:in_progress</disposition>
            <readPoint>
                <id>urn:epc:id:sgln:0614141.00000.0</id>
            </readPoint>
            <extension>
                <quantityList>

```

<!-- In this example, the EPCIS quantityElement data structure contains the lgtin for the lowest saleable unit (LSU) and the quantity value is given in terms of LSUs. For this example scenario, each ordered case contains 12 LSUs. Hence, the quantity value will be computed by multiplying the order case quantity with 12 LSUs. -->

```
<quantityElement>
  <epcClass>urn:epc:class:lgtin:030000.0000001.L1</epcClass>
  <quantity>120</quantity>
</quantityElement>
</quantityList>
<sourceList>
  <source
type="urn:epcglobal:cbv:sdt:owning_party">urn:epc:id:sgln:030000.000000.0</source>
  </sourceList>
  <destinationList>
    <destination
type="urn:epcglobal:cbv:sdt:owning_party">urn:epc:id:sgln:0614141.00000.0</destination>
  </destinationList>
</extension>
</ObjectEvent>
</EventList>
</EPCISBody>
</epcis:EPCISDocument>
```

## 12.9 Damage Shipment

### 12.9.1 Damaged Product is Returned to Seller

#### 12.9.1.1 Sample XML: Exchange1 - Seller → Buyer

Reference File: <https://resources.gs1us.org/Portals/0/xml/LotException-DamagedShipmentReturn-SellerExchange1.xml>

```
<?xml version="1.0" encoding="UTF-8"?>
<!-- Lot Exception: DAMAGE SHIPMENT (DAMAGED PRODUCT IS RETURNED TO SELLER) - Exchange1: Seller
-> Buyer-->
<!--Seller ships correct 10 cases with correct DSCSA transmission to the Buyer; however 1 case
arrives damaged. -->
<epcis:EPCISDocument xmlns:cbvmda="urn:epcglobal:cbv:mda"
xmlns:sbdh="http://www.unece.org/cefact/namespaces/StandardBusinessDocumentHeader"
xmlns:gslushc="http://epcis.gslus.org/hc/ns" xmlns:epcis="urn:epcglobal:epcis:xsd:1"
schemaVersion="1.2" xsi:schemaLocation="urn:epcglobal:epcis:xsd:1 EPCglobal-epcis-1_2.xsd"
xmlns:xsi="http://www.w3.org/2001/XMLSchema-instance" creationDate="2014-04-01T15:14:27.574-
04:00">
  <EPCISHeader>
    <sbdh:StandardBusinessDocumentHeader>
      <sbdh:HeaderVersion>1.0</sbdh:HeaderVersion>
      <sbdh:Sender>
        <sbdh:Identifier
Authority="SGLN">urn:epc:id:sgln:030000.000000.0</sbdh:Identifier>
        </sbdh:Sender>
        <sbdh:Receiver>
          <sbdh:Identifier
Authority="SGLN">urn:epc:id:sgln:0614141.00000.0</sbdh:Identifier>
          </sbdh:Receiver>
          <sbdh:DocumentIdentification>
            <sbdh:Standard>EPCglobal</sbdh:Standard>
            <sbdh:TypeVersion>1.0</sbdh:TypeVersion>
            <sbdh:InstanceIdentifier>1234567850</sbdh:InstanceIdentifier>
            <sbdh:Type>Events</sbdh:Type>
            <sbdh:CreationDateAndTime>2014-04-01T15:14:27.574-04:00</sbdh:CreationDateAndTime>
          </sbdh:DocumentIdentification>
        </sbdh:StandardBusinessDocumentHeader>
        <extension>
          <EPCISMasterData>
            <VocabularyList>
              <Vocabulary type="urn:epcglobal:epcis:vtype:EPCClass">
                <VocabularyElementList>
                  <VocabularyElement id="urn:epc:class:lgtin:030000.0000001.L1">
                    <attribute id="urn:epcglobal:cbv:mda#itemExpirationDate">2017-10-
31</attribute>
                  </VocabularyElement>
                  <VocabularyElement id="urn:epc:idpat:sgtin:030000.0000001.*">
                    <attribute
id="urn:epcglobal:cbv:mda#additionalTradeItemIdentification">00000000001</attribute>
                    <attribute
id="urn:epcglobal:cbv:mda#additionalTradeItemIdentificationTypeCode">FDA_NDC_11</attribute>
                    <attribute
id="urn:epcglobal:cbv:mda#regulatedProductName">Epcistra</attribute>
                    <attribute
id="urn:epcglobal:cbv:mda#manufacturerOfTradeItemPartyName">GS1 Pharma LLC</attribute>
                    <attribute id="urn:epcglobal:cbv:mda#dosageFormType">PILL</attribute>
                  </VocabularyElementList>
                </Vocabulary>
              </VocabularyList>
            </EPCISMasterData>
          </extension>
        </EPCISDocument>
      </epcis:EPCISDocument>
    </epcis:EPCISDocument>
  </epcis:EPCISDocument>
</epcis:EPCISDocument>
```

```

        <attribute
id="urn:epcglobal:cbv:mda#strengthDescription">100mg</attribute>
        <attribute id="urn:epcglobal:cbv:mda#netContentDescription">500
pills</attribute>
    </VocabularyElement>
</VocabularyElementList>
</Vocabulary>
<Vocabulary type="urn:epcglobal:epcis:vtype:Location">
    <VocabularyElementList>
        <VocabularyElement id="urn:epc:id:sgln:030000.000000.0">
            <attribute id="urn:epcglobal:cbv:mda#name">GS1 Pharma LLC</attribute>
            <attribute id="urn:epcglobal:cbv:mda#streetAddressOne">1295 S George
Ave</attribute>
            <attribute id="urn:epcglobal:cbv:mda#streetAddressTwo">Room
378</attribute>
            <attribute id="urn:epcglobal:cbv:mda#city">Washington</attribute>
            <attribute id="urn:epcglobal:cbv:mda#state">DC</attribute>
            <attribute id="urn:epcglobal:cbv:mda#postalCode">12345-
6789</attribute>
            <attribute id="urn:epcglobal:cbv:mda#countryCode">US</attribute>
        </VocabularyElement>
    <VocabularyElement id="urn:epc:id:sgln:0614141.000000.0">
        <attribute id="urn:epcglobal:cbv:mda#name">GS1 Drug Distro
LLC</attribute>
        <attribute id="urn:epcglobal:cbv:mda#streetAddressOne">230 Park Ave
S</attribute>
        <attribute id="urn:epcglobal:cbv:mda#city">New York</attribute>
        <attribute id="urn:epcglobal:cbv:mda#state">NY</attribute>
        <attribute id="urn:epcglobal:cbv:mda#postalCode">10003-
1502</attribute>
            <attribute id="urn:epcglobal:cbv:mda#countryCode">US</attribute>
        </VocabularyElement>
    </VocabularyElementList>
</Vocabulary>
</VocabularyList>
</EPCISMasterData>
</extension>
<gslushc:dscsaTransactionStatement>
    <gslushc:affirmTransactionStatement>true</gslushc:affirmTransactionStatement>
    <gslushc:legalNotice>Seller has complied with each applicable subsection of FDCA Sec.
581 (27) (A) - (G).</gslushc:legalNotice>
</gslushc:dscsaTransactionStatement>
</EPCISHeader>
<EPCISBody>
    <EventList>
        <!-- Transaction Information (TI) -->
        <ObjectEvent>
            <eventTime>2014-04-01T10:11:12Z</eventTime>
            <eventTimeZoneOffset>-05:00</eventTimeZoneOffset>
            <epcList/>
            <action>OBSERVE</action>
            <bizStep>urn:epcglobal:cbv:bizstep:shipping</bizStep>
            <disposition>urn:epcglobal:cbv:disp:in_transit</disposition>
            <readPoint>
                <id>urn:epc:id:sgln:030000.000000.0</id>
            </readPoint>
            <extension>
                <quantityList>
                    <!-- In this example, the EPCIS quantityElement data structure contains the
lgtin for the lowest saleable unit (LSU) and the quantity value is given in terms of LSUs. For

```

this example scenario, each ordered case contains 12 LSUs. Hence, the quantity value will be computed by multiplying the order case quantity with 12 LSUs. -->

```

    <quantityElement>
      <epcClass>urn:epc:class:lgtin:030000.0000001.L1</epcClass>
      <quantity>120</quantity>
    </quantityElement>
  </quantityList>
  <sourceList>
    <source
type="urn:epcglobal:cbv:sdt:owning_party">urn:epc:id:sgln:030000.000000.0</source>
  </sourceList>
  <destinationList>
    <destination
type="urn:epcglobal:cbv:sdt:owning_party">urn:epc:id:sgln:0614141.00000.0</destination>
  </destinationList>
</extension>
</ObjectEvent>
</EventList>
</EPCISBody>
</epcis:EPCISDocument>

```

### 12.9.1.2 Sample XML: Buyer Receives Product

Reference File: <https://resources.gs1us.org/Portals/0/xml/LotException-DamagedShipmentReturn-BuyerReceives.xml>

```

<?xml version="1.0" encoding="UTF-8"?>
<!-- Lot Exception: DAMAGE SHIPMENT (DAMAGED PRODUCT IS RETURNED TO SELLER) - Buyer Receives Product -->
<!-- Buyer receives into inventory 9 cases with supporting DSCSA data. Buyer generates receiving event with status of damaged for the 1 case that arrives damaged. -->
<epcis:EPCISDocument xmlns:cbvmda="urn:epcglobal:cbv:mda"
xmlns:sbdh="http://www.unece.org/cefact/namespaces/StandardBusinessDocumentHeader"
xmlns:gslushc="http://epcis.gs1us.org/hc/ns" xmlns:epcis="urn:epcglobal:epcis:xsd:1"
schemaVersion="1.2" xsi:schemaLocation="urn:epcglobal:epcis:xsd:1 EPCglobal-epcis-1_2.xsd"
xmlns:xsi="http://www.w3.org/2001/XMLSchema-instance" creationDate="2014-04-02T15:14:27.574-04:00">
  <EPCISHeader>
    <sbdh:StandardBusinessDocumentHeader>
      <sbdh:HeaderVersion>1.0</sbdh:HeaderVersion>
      <sbdh:Sender>
        <sbdh:Identifier
Authority="SGLN">urn:epc:id:sgln:0614141.00000.0</sbdh:Identifier>
      </sbdh:Sender>
      <sbdh:Receiver>
        <sbdh:Identifier
Authority="SGLN">urn:epc:id:sgln:0614141.11111.0</sbdh:Identifier>
      </sbdh:Receiver>
      <sbdh:DocumentIdentification>
        <sbdh:Standard>EPCglobal</sbdh:Standard>
        <sbdh:TypeVersion>1.0</sbdh:TypeVersion>
        <sbdh:InstanceIdentifier>1234567851</sbdh:InstanceIdentifier>
        <sbdh:Type>Events</sbdh:Type>
        <sbdh:CreationDateAndTime>2014-04-02T15:14:27.574-04:00</sbdh:CreationDateAndTime>
      </sbdh:DocumentIdentification>
    </sbdh:StandardBusinessDocumentHeader>
    <extension>
      <EPCISMasterData>
        <VocabularyList>
          <Vocabulary type="urn:epcglobal:epcis:vtype:EPCClass">

```



```

    <VocabularyElementList>
      <VocabularyElement id="urn:epc:class:lgtn:030000.0000001.L1">
        <attribute id="urn:epcglobal:cbv:mda#itemExpirationDate">2017-10-
31</attribute>
      </VocabularyElement>
      <VocabularyElement id="urn:epc:idpat:sgtin:030000.0000001.*">
        <attribute
id="urn:epcglobal:cbv:mda#additionalTradeItemIdentification">00000000001</attribute>
        <attribute
id="urn:epcglobal:cbv:mda#additionalTradeItemIdentificationTypeCode">FDA_NDC_11</attribute>
        <attribute
id="urn:epcglobal:cbv:mda#regulatedProductName">Epcistra</attribute>
        <attribute
id="urn:epcglobal:cbv:mda#manufacturerOfTradeItemPartyName">GS1 Pharma LLC</attribute>
        <attribute id="urn:epcglobal:cbv:mda#dosageFormType">PILL</attribute>
        <attribute
id="urn:epcglobal:cbv:mda#strengthDescription">100mg</attribute>
        <attribute id="urn:epcglobal:cbv:mda#netContentDescription">500
pills</attribute>
      </VocabularyElement>
    </VocabularyElementList>
  </Vocabulary>
  <Vocabulary type="urn:epcglobal:epcis:vtype:Location">
    <VocabularyElementList>
      <VocabularyElement id="urn:epc:id:sgln:030000.000000.0">
        <attribute id="urn:epcglobal:cbv:mda#name">GS1 Pharma LLC</attribute>
        <attribute id="urn:epcglobal:cbv:mda#streetAddressOne">1295 S George
Ave</attribute>
        <attribute id="urn:epcglobal:cbv:mda#streetAddressTwo">Room
378</attribute>
        <attribute id="urn:epcglobal:cbv:mda#city">Washington</attribute>
        <attribute id="urn:epcglobal:cbv:mda#state">DC</attribute>
        <attribute id="urn:epcglobal:cbv:mda#postalCode">12345-
6789</attribute>
        <attribute id="urn:epcglobal:cbv:mda#countryCode">US</attribute>
      </VocabularyElement>
      <VocabularyElement id="urn:epc:id:sgln:0614141.00000.0">
        <attribute id="urn:epcglobal:cbv:mda#name">GS1 Drug Distro
LLC</attribute>
        <attribute id="urn:epcglobal:cbv:mda#streetAddressOne">230 Park Ave
S</attribute>
        <attribute id="urn:epcglobal:cbv:mda#city">New York</attribute>
        <attribute id="urn:epcglobal:cbv:mda#state">NY</attribute>
        <attribute id="urn:epcglobal:cbv:mda#postalCode">10003-
1502</attribute>
        <attribute id="urn:epcglobal:cbv:mda#countryCode">US</attribute>
      </VocabularyElement>
    </VocabularyElementList>
  </Vocabulary>
</VocabularyList>
</EPCISMasterData>
</extension>
</EPCISHeader>
<EPCISBody>
  <EventList>
    <!-- 9 cases are received into inventory -->
    <ObjectEvent>
      <eventTime>2014-04-02T10:11:12Z</eventTime>
      <eventTimeZoneOffset>-05:00</eventTimeZoneOffset>
      <epcList/>
      <action>OBSERVE</action>
    </ObjectEvent>
  </EventList>

```

```

<bizStep>urn:epcglobal:cbv:bizstep:receiving</bizStep>
<disposition>urn:epcglobal:cbv:disp:in_progress</disposition>
<readPoint>
  <id>urn:epc:id:sgln:0614141.00000.0</id>
</readPoint>
<extension>
  <quantityList>
    <!-- In this example, the EPCIS quantityElement data structure contains the
lgtin for the lowest saleable unit (LSU) and the quantity value is given in terms of LSUs. For
this example scenario,each ordered case contains 12 LSUs. Hence, the quantity value will be
computed by multiplying the order case quantity with 12 LSUs. -->
    <quantityElement>
      <epcClass>urn:epc:class:lgtin:030000.0000001.L1</epcClass>
      <quantity>108</quantity>
    </quantityElement>
  </quantityList>
  <sourceList>
    <source
type="urn:epcglobal:cbv:sdt:owning_party">urn:epc:id:sgln:030000.000000.0</source>
    </sourceList>
    <destinationList>
      <destination
type="urn:epcglobal:cbv:sdt:owning_party">urn:epc:id:sgln:0614141.00000.0</destination>
      </destinationList>
    </extension>
  </ObjectEvent>
  <!-- 1 damaged case is received with status of damaged -->
  <ObjectEvent>
    <eventTime>2014-04-02T10:12:12Z</eventTime>
    <eventTimeZoneOffset>-05:00</eventTimeZoneOffset>
    <epcList/>
    <action>OBSERVE</action>
    <bizStep>urn:epcglobal:cbv:bizstep:receiving</bizStep>
    <disposition>urn:epcglobal:cbv:disp:damaged</disposition>
    <readPoint>
      <id>urn:epc:id:sgln:0614141.00000.0</id>
    </readPoint>
    <extension>
      <quantityList>
        <!-- In this example, the EPCIS quantityElement data structure contains the
lgtin for the lowest saleable unit (LSU) and the quantity value is given in terms of LSUs. For
this example scenario,each ordered case contains 12 LSUs. Hence, the quantity value will be
computed by multiplying the order case quantity with 12 LSUs. -->
        <quantityElement>
          <epcClass>urn:epc:class:lgtin:030000.0000001.L1</epcClass>
          <quantity>12</quantity>
        </quantityElement>
      </quantityList>
      <sourceList>
        <source
type="urn:epcglobal:cbv:sdt:owning_party">urn:epc:id:sgln:030000.000000.0</source>
        </sourceList>
        <destinationList>
          <destination
type="urn:epcglobal:cbv:sdt:owning_party">urn:epc:id:sgln:0614141.00000.0</destination>
          </destinationList>
        </extension>
      </ObjectEvent>
    </EventList>
  </EPCISBody>
</epcis:EPCISDocument>

```

### 12.9.1.3 Sample XML: Exchange1 - Buyer → Seller

Reference File: <https://resources.gs1us.org/Portals/0/xml/LotException-DamagedShipmentReturn-BuyerExchange1.xml>

```
<?xml version="1.0" encoding="UTF-8"?>
<!-- Lot Exception:DAMAGE SHIPMENT (DAMAGED PRODUCT IS RETURNED TO SELLER) - Exchange1: Buyer -
> Seller -->
<!-- Buyer returns 1 damaged case to the seller -->
<epcis:EPCISDocument xmlns:cbvmda="urn:epcglobal:cbv:mda"
xmlns:sbdh="http://www.unece.org/cefact/namespaces/StandardBusinessDocumentHeader"
xmlns:gslushc="http://epcis.gs1us.org/hc/ns" xmlns:epcis="urn:epcglobal:epcis:xsd:1"
schemaVersion="1.2" xsi:schemaLocation="urn:epcglobal:epcis:xsd:1 EPCglobal-epcis-1_2.xsd"
xmlns:xsi="http://www.w3.org/2001/XMLSchema-instance" creationDate="2014-04-03T15:14:27.574-
04:00">
  <EPCISHeader>
    <sbdh:StandardBusinessDocumentHeader>
      <sbdh:HeaderVersion>1.0</sbdh:HeaderVersion>
      <sbdh:Sender>
        <sbdh:Identifier
Authority="SGLN">urn:epc:id:sgln:0614141.00000.0</sbdh:Identifier>
        </sbdh:Identifier>
        <sbdh:Receiver>
          <sbdh:Identifier
Authority="SGLN">urn:epc:id:sgln:030000.000000.0</sbdh:Identifier>
          </sbdh:Identifier>
        <sbdh:DocumentIdentification>
          <sbdh:Standard>EPCglobal</sbdh:Standard>
          <sbdh:TypeVersion>1.0</sbdh:TypeVersion>
          <sbdh:InstanceIdentifier>1234567852</sbdh:InstanceIdentifier>
          <sbdh:Type>Events</sbdh:Type>
          <sbdh:CreationDateAndTime>2014-04-03T15:14:27.574-04:00</sbdh:CreationDateAndTime>
        </sbdh:DocumentIdentification>
      </sbdh:StandardBusinessDocumentHeader>
      <extension>
        <EPCISMasterData>
          <VocabularyList>
            <Vocabulary type="urn:epcglobal:epcis:vtype:EPCClass">
              <VocabularyElementList>
                <VocabularyElement id="urn:epc:class:lgtn:030000.0000001.L1">
                  <attribute id="urn:epcglobal:cbv:mda#itemExpirationDate">2017-10-
31</attribute>
                </VocabularyElement>
                <VocabularyElement id="urn:epc:idpat:sgtin:030000.0000001.*">
                  <attribute
id="urn:epcglobal:cbv:mda#additionalTradeItemIdentification">0000000001</attribute>
                  <attribute
id="urn:epcglobal:cbv:mda#additionalTradeItemIdentificationTypeCode">FDA_NDC_11</attribute>
                  <attribute
id="urn:epcglobal:cbv:mda#regulatedProductName">Epcistra</attribute>
                  <attribute
id="urn:epcglobal:cbv:mda#manufacturerOfTradeItemPartyName">GS1 Pharma LLC</attribute>
                  <attribute id="urn:epcglobal:cbv:mda#dosageFormType">PILL</attribute>
                  <attribute
id="urn:epcglobal:cbv:mda#strengthDescription">100mg</attribute>
                  <attribute id="urn:epcglobal:cbv:mda#netContentDescription">500
pills</attribute>
                </VocabularyElement>
              </VocabularyElementList>
            </Vocabulary>
          <Vocabulary type="urn:epcglobal:epcis:vtype:Location">
```

```

    <VocabularyElementList>
      <VocabularyElement id="urn:epc:id:sgln:030000.000000.0">
        <attribute id="urn:epcglobal:cbv:mda#name">GS1 Pharma LLC</attribute>
        <attribute id="urn:epcglobal:cbv:mda#streetAddressOne">1295 S George
Ave</attribute>
        <attribute id="urn:epcglobal:cbv:mda#streetAddressTwo">Room
378</attribute>
        <attribute id="urn:epcglobal:cbv:mda#city">Washington</attribute>
        <attribute id="urn:epcglobal:cbv:mda#state">DC</attribute>
        <attribute id="urn:epcglobal:cbv:mda#postalCode">12345-
6789</attribute>
        <attribute id="urn:epcglobal:cbv:mda#countryCode">US</attribute>
      </VocabularyElement>
      <VocabularyElement id="urn:epc:id:sgln:0614141.00000.0">
        <attribute id="urn:epcglobal:cbv:mda#name">GS1 Drug Distro
LLC</attribute>
        <attribute id="urn:epcglobal:cbv:mda#streetAddressOne">230 Park Ave
S</attribute>
        <attribute id="urn:epcglobal:cbv:mda#city">New York</attribute>
        <attribute id="urn:epcglobal:cbv:mda#state">NY</attribute>
        <attribute id="urn:epcglobal:cbv:mda#postalCode">10003-
1502</attribute>
        <attribute id="urn:epcglobal:cbv:mda#countryCode">US</attribute>
      </VocabularyElement>
    </VocabularyElementList>
  </Vocabulary>
</VocabularyList>
</EPCISMasterData>
</extension>
<gslushc:dscsaTransactionStatement>
  <gslushc:affirmTransactionStatement>true</gslushc:affirmTransactionStatement>
  <gslushc:legalNotice>Buyer has complied with each applicable subsection of FDCA Sec.
581 (27) (A) - (G).</gslushc:legalNotice>
</gslushc:dscsaTransactionStatement>
</EPCISHeader>
<EPCISBody>
  <EventList>
    <!-- Transaction Information (TI) -->
    <ObjectEvent>
      <eventTime>2014-04-03T10:11:12Z</eventTime>
      <eventTimeZoneOffset>-05:00</eventTimeZoneOffset>
      <epcList/>
      <action>OBSERVE</action>
      <bizStep>urn:epcglobal:cbv:bizstep:shipping</bizStep>
      <disposition>urn:epcglobal:cbv:disp:in_transit</disposition>
      <readPoint>
        <id>urn:epc:id:sgln:0614141.00000.0</id>
      </readPoint>
      <extension>
        <quantityList>
          <!-- In this example, the EPCIS quantityElement data structure contains the
lgtin for the lowest saleable unit (LSU) and the quantity value is given in terms of LSUs. For
this example scenario, each ordered case contains 12 LSUs. Hence, the quantity value will be
computed by multiplying the order case quantity with 12 LSUs. -->
          <quantityElement>
            <epcClass>urn:epc:class:lgtin:030000.0000001.L1</epcClass>
            <quantity>12</quantity>
          </quantityElement>
        </quantityList>
      </extension>
    </ObjectEvent>
  </EventList>
</EPCISBody>
</EPCISHeader>
</EPCISMessage>

```

```

                <source
type="urn:epcglobal:cbv:sdt:owning_party">urn:epc:id:sgln:0614141.00000.0</source>
                </sourceList>
                <destinationList>
                <destination
type="urn:epcglobal:cbv:sdt:owning_party">urn:epc:id:sgln:030000.000000.0</destination>
                </destinationList>
                </extension>
            </ObjectEvent>
        </EventList>
    </EPCISBody>
</epcis:EPCISDocument>

```

### 12.9.1.4 Sample XML: Seller Receives Returned Product

Reference File: <https://resources.gs1us.org/Portals/0/xml/LotException-DamagedShipmentReturn-SellerReceives.xml>

```

<?xml version="1.0" encoding="UTF-8"?>
<!-- Lot Exception: DAMAGE SHIPMENT (DAMAGED PRODUCT IS RETURNED TO SELLER) - Seller Receives
Return Product -->
<!--Seller receives 1 returned case from Buyer -->
<epcis:EPCISDocument xmlns:cbvmda="urn:epcglobal:cbv:mda"
xmlns:sbdh="http://www.unece.org/cefact/namespaces/StandardBusinessDocumentHeader"
xmlns:gslushc="http://epcis.gs1us.org/hc/ns" xmlns:epcis="urn:epcglobal:epcis:xsd:1"
schemaVersion="1.2" xsi:schemaLocation="urn:epcglobal:epcis:xsd:1 EPCglobal-epcis-1_2.xsd"
xmlns:xsi="http://www.w3.org/2001/XMLSchema-instance" creationDate="2014-04-04T15:14:27.574-
04:00">
    <EPCISHeader>
        <sbdh:StandardBusinessDocumentHeader>
            <sbdh:HeaderVersion>1.0</sbdh:HeaderVersion>
            <sbdh:Sender>
                <sbdh:Identifier
Authority="SGLN">urn:epc:id:sgln:030000.000000.0</sbdh:Identifier>
            </sbdh:Sender>
            <sbdh:Receiver>
                <sbdh:Identifier
Authority="SGLN">urn:epc:id:sgln:030000.111111.0</sbdh:Identifier>
            </sbdh:Receiver>
            <sbdh:DocumentIdentification>
                <sbdh:Standard>EPCglobal</sbdh:Standard>
                <sbdh:TypeVersion>1.0</sbdh:TypeVersion>
                <sbdh:InstanceIdentifier>1234567853</sbdh:InstanceIdentifier>
                <sbdh:Type>Events</sbdh:Type>
                <sbdh:CreationDateAndTime>2014-04-04T15:14:27.574-04:00</sbdh:CreationDateAndTime>
            </sbdh:DocumentIdentification>
        </sbdh:StandardBusinessDocumentHeader>
        <extension>
            <EPCISMasterData>
                <VocabularyList>
                    <Vocabulary type="urn:epcglobal:epcis:vtype:EPCClass">
                        <VocabularyElementList>
                            <VocabularyElement id="urn:epc:class:lgtin:030000.0000001.L1">
                                <attribute id="urn:epcglobal:cbv:mda#itemExpirationDate">2017-10-
31</attribute>
                            </VocabularyElement>
                            <VocabularyElement id="urn:epc:idpat:sgtin:030000.0000001.*">
                                <attribute
id="urn:epcglobal:cbv:mda#additionalTradeItemIdentification">00000000001</attribute>

```

```

        <attribute
id="urn:epcglobal:cbv:mda#additionalTradeItemIdentificationTypeCode">FDA_NDC_11</attribute>
        <attribute
id="urn:epcglobal:cbv:mda#regulatedProductName">Epcistra</attribute>
        <attribute
id="urn:epcglobal:cbv:mda#manufacturerOfTradeItemPartyName">GS1 Pharma LLC</attribute>
        <attribute id="urn:epcglobal:cbv:mda#dosageFormType">PILL</attribute>
        <attribute
id="urn:epcglobal:cbv:mda#strengthDescription">100mg</attribute>
        <attribute id="urn:epcglobal:cbv:mda#netContentDescription">500
pills</attribute>
    </VocabularyElement>
</VocabularyElementList>
</Vocabulary>
<Vocabulary type="urn:epcglobal:epcis:vtype:Location">
    <VocabularyElementList>
        <VocabularyElement id="urn:epc:id:sgln:030000.000000.0">
            <attribute id="urn:epcglobal:cbv:mda#name">GS1 Pharma LLC</attribute>
            <attribute id="urn:epcglobal:cbv:mda#streetAddressOne">1295 S George
Ave</attribute>
            <attribute id="urn:epcglobal:cbv:mda#streetAddressTwo">Room
378</attribute>
            <attribute id="urn:epcglobal:cbv:mda#city">Washington</attribute>
            <attribute id="urn:epcglobal:cbv:mda#state">DC</attribute>
            <attribute id="urn:epcglobal:cbv:mda#postalCode">12345-
6789</attribute>
            <attribute id="urn:epcglobal:cbv:mda#countryCode">US</attribute>
        </VocabularyElement>
        <VocabularyElement id="urn:epc:id:sgln:0614141.000000.0">
            <attribute id="urn:epcglobal:cbv:mda#name">GS1 Drug Distro
LLC</attribute>
            <attribute id="urn:epcglobal:cbv:mda#streetAddressOne">230 Park Ave
S</attribute>
            <attribute id="urn:epcglobal:cbv:mda#city">New York</attribute>
            <attribute id="urn:epcglobal:cbv:mda#state">NY</attribute>
            <attribute id="urn:epcglobal:cbv:mda#postalCode">10003-
1502</attribute>
            <attribute id="urn:epcglobal:cbv:mda#countryCode">US</attribute>
        </VocabularyElement>
    </VocabularyElementList>
</Vocabulary>
</VocabularyList>
</EPCISMasterData>
</extension>
</EPCISHeader>
<EPCISBody>
    <EventList>
        <ObjectEvent>
            <eventTime>2014-04-04T10:11:12Z</eventTime>
            <eventTimeZoneOffset>-05:00</eventTimeZoneOffset>
            <epcList/>
            <action>OBSERVE</action>
            <bizStep>urn:epcglobal:cbv:bizstep:receiving</bizStep>
            <disposition>urn:epcglobal:cbv:disp:damaged</disposition>
            <readPoint>
                <id>urn:epc:id:sgln:030000.000000.0</id>
            </readPoint>
            <extension>
                <quantityList>
                    <!-- In this example, the EPCIS quantityElement data structure contains the
lgtin for the lowest saleable unit (LSU) and the quantity value is given in terms of LSUs. For

```

this example scenario, each ordered case contains 12 LSUs. Hence, the quantity value will be computed by multiplying the order case quantity with 12 LSUs. -->

```

    <quantityElement>
      <epcClass>urn:epc:class:lgtn:030000.0000001.L1</epcClass>
      <quantity>12</quantity>
    </quantityElement>
  </quantityList>
  <sourceList>
    <source
type="urn:epcglobal:cbv:sdt:owning_party">urn:epc:id:sgln:0614141.00000.0</source>
  </sourceList>
  <destinationList>
    <destination
type="urn:epcglobal:cbv:sdt:owning_party">urn:epc:id:sgln:030000.000000.0</destination>
  </destinationList>
</extension>
</ObjectEvent>
</EventList>
</EPCISBody>
</epcis:EPCISDocument>

```

## 12.9.2 Damaged Product is Destroyed

### 12.9.2.1 Sample XML: Exchange1 - Seller → Buyer



**Note:** The message content of *Exchange1 of Seller -> Buyer* in this example is identical to the content of the *Exchange1 of Seller -> Buyer* in the [Damaged Shipment \(Damage Product is Returned to Seller\)](#) example.

Reference File: <https://resources.gs1us.org/Portals/0/xml/LotException-DamagedShipmentDestroy-SellerExchange1.xml>

```

<?xml version="1.0" encoding="UTF-8"?>
<!-- Lot Exception: DAMAGE SHIPMENT (DAMAGED PRODUCT IS DESTROYED) - Exchange1: Seller ->
Buyer-->
<!--Seller ships correct 10 cases with correct DSCSA transmission to the Buyer; however 1 case
arrives damaged. -->
<!-- Note: The content for this example is identical to the content for the Seller to Buyer
transaction for
DAMAGE SHIPMENT (DAMAGED PRODUCT IS RETURNED TO SELLER) - Exchange1 -->
<epcis:EPCISDocument xmlns:cbvmda="urn:epcglobal:cbv:mda"
xmlns:sbdh="http://www.unece.org/cefact/namespaces/StandardBusinessDocumentHeader"
xmlns:gslushc="http://epcis.gslus.org/hc/ns" xmlns:epcis="urn:epcglobal:epcis:xsd:1"
schemaVersion="1.2" xsi:schemaLocation="urn:epcglobal:epcis:xsd:1 EPCglobal-epcis-1_2.xsd"
xmlns:xsi="http://www.w3.org/2001/XMLSchema-instance" creationDate="2014-04-01T15:14:27.574-
04:00">
  <EPCISHeader>
    <sbdh:StandardBusinessDocumentHeader>
      <sbdh:HeaderVersion>1.0</sbdh:HeaderVersion>
      <sbdh:Sender>
        <sbdh:Identifier
Authority="SGLN">urn:epc:id:sgln:030000.000000.0</sbdh:Identifier>
      </sbdh:Sender>
      <sbdh:Receiver>
        <sbdh:Identifier
Authority="SGLN">urn:epc:id:sgln:0614141.00000.0</sbdh:Identifier>
      </sbdh:Receiver>
      <sbdh:DocumentIdentification>

```



```

    <sbdh:Standard>EPCglobal</sbdh:Standard>
    <sbdh:TypeVersion>1.0</sbdh:TypeVersion>
    <sbdh:InstanceIdentifier>1234567850</sbdh:InstanceIdentifier>
    <sbdh:Type>Events</sbdh:Type>
    <sbdh:CreationDateAndTime>2014-04-01T15:14:27.574-04:00</sbdh:CreationDateAndTime>
  </sbdh:DocumentIdentification>
</sbdh:StandardBusinessDocumentHeader>
<extension>
  <EPCISMasterData>
    <VocabularyList>
      <Vocabulary type="urn:epcglobal:epcis:vtype:EPCClass">
        <VocabularyElementList>
          <VocabularyElement id="urn:epc:class:lgtin:030000.0000001.L1">
            <attribute id="urn:epcglobal:cbv:mda#itemExpirationDate">2017-10-
31</attribute>
              </VocabularyElement>
          <VocabularyElement id="urn:epc:idpat:sgtin:030000.0000001.*">
            <attribute
id="urn:epcglobal:cbv:mda#additionalTradeItemIdentification">0000000001</attribute>
              <attribute
id="urn:epcglobal:cbv:mda#additionalTradeItemIdentificationTypeCode">FDA_NDC_11</attribute>
              <attribute
id="urn:epcglobal:cbv:mda#regulatedProductName">Epcistra</attribute>
              <attribute
id="urn:epcglobal:cbv:mda#manufacturerOfTradeItemPartyName">GS1 Pharma LLC</attribute>
              <attribute id="urn:epcglobal:cbv:mda#dosageFormType">PILL</attribute>
              <attribute
id="urn:epcglobal:cbv:mda#strengthDescription">100mg</attribute>
              <attribute id="urn:epcglobal:cbv:mda#netContentDescription">500
pills</attribute>
            </VocabularyElement>
          </VocabularyElementList>
        </Vocabulary>
      <Vocabulary type="urn:epcglobal:epcis:vtype:Location">
        <VocabularyElementList>
          <VocabularyElement id="urn:epc:id:sgln:030000.000000.0">
            <attribute id="urn:epcglobal:cbv:mda#name">GS1 Pharma LLC</attribute>
            <attribute id="urn:epcglobal:cbv:mda#streetAddressOne">1295 S George
Ave</attribute>
            <attribute id="urn:epcglobal:cbv:mda#streetAddressTwo">Room
378</attribute>
            <attribute id="urn:epcglobal:cbv:mda#city">Washington</attribute>
            <attribute id="urn:epcglobal:cbv:mda#state">DC</attribute>
            <attribute id="urn:epcglobal:cbv:mda#postalCode">12345-
6789</attribute>
            <attribute id="urn:epcglobal:cbv:mda#countryCode">US</attribute>
          </VocabularyElement>
          <VocabularyElement id="urn:epc:id:sgln:0614141.00000.0">
            <attribute id="urn:epcglobal:cbv:mda#name">GS1 Drug Distro
LLC</attribute>
            <attribute id="urn:epcglobal:cbv:mda#streetAddressOne">230 Park Ave
S</attribute>
            <attribute id="urn:epcglobal:cbv:mda#city">New York</attribute>
            <attribute id="urn:epcglobal:cbv:mda#state">NY</attribute>
            <attribute id="urn:epcglobal:cbv:mda#postalCode">10003-
1502</attribute>
            <attribute id="urn:epcglobal:cbv:mda#countryCode">US</attribute>
          </VocabularyElement>
        </VocabularyElementList>
      </Vocabulary>
    </VocabularyList>
  </EPCISMasterData>
</extension>

```



```

    </EPCISMasterData>
  </extension>
  <gslushc:dscsaTransactionStatement>
    <gslushc:affirmTransactionStatement>true</gslushc:affirmTransactionStatement>
    <gslushc:legalNotice>Seller has complied with each applicable subsection of FDCA Sec.
581 (27) (A) - (G).</gslushc:legalNotice>
  </gslushc:dscsaTransactionStatement>
</EPCISHeader>
<EPCISBody>
  <EventList>
    <!-- Transaction Information (TI) -->
    <ObjectEvent>
      <eventTime>2014-04-01T10:11:12Z</eventTime>
      <eventTimeZoneOffset>-05:00</eventTimeZoneOffset>
      <epcList/>
      <action>OBSERVE</action>
      <bizStep>urn:epcglobal:cbv:bizstep:shipping</bizStep>
      <disposition>urn:epcglobal:cbv:disp:in_transit</disposition>
      <readPoint>
        <id>urn:epc:id:sgln:030000.000000.0</id>
      </readPoint>
      <extension>
        <quantityList>
          <quantityElement>
            <!-- In this example, the EPCIS quantityElement data structure contains
the lgtin for the lowest saleable unit (LSU) and the quantity value is given in terms of LSUs.
For this example scenario, each ordered case contains 12 LSUs. Hence, the quantity value will
be computed by multiplying the order case quantity with 12 LSUs. -->
            <epcClass>urn:epc:class:lgtin:030000.0000001.L1</epcClass>
            <quantity>120</quantity>
          </quantityElement>
        </quantityList>
        <sourceList>
          <source
type="urn:epcglobal:cbv:sdt:owning_party">urn:epc:id:sgln:030000.000000.0</source>
        </sourceList>
        <destinationList>
          <destination
type="urn:epcglobal:cbv:sdt:owning_party">urn:epc:id:sgln:0614141.00000.0</destination>
        </destinationList>
      </extension>
    </ObjectEvent>
  </EventList>
</EPCISBody>
</epcis:EPCISDocument>

```

### 12.9.2.2 Sample XML: Buyer Receives Product



**Note:** The message content of *Buyer Receives Product* in this example is identical to the content of the *Buyer Receives Product* in the [Damaged Shipment \(Damage Product is Returned to Seller\)](#) example.

Reference File: <https://resources.gs1us.org/Portals/0/xml/LotException-DamagedShipmentDestroy-BuyerReceives.xml>

```

<?xml version="1.0" encoding="UTF-8"?>
<!-- Lot Exception: DAMAGE SHIPMENT (DAMAGED PRODUCT IS DESTROYED) - Buyer Receives Product --
>
<!-- Buyer receives into inventory 9 cases with supporting DSCSA data.

```

```

Buyer generates receiving event with status of damaged for the 1 case that arrives
damaged. -->
<!-- Note: The content for this receiving example is identical to the content of the
transaction showing DAMAGE SHIPMENT (DAMAGED PRODUCT IS RETURNED TO SELLER) - Buyer Receives
Product -->
<epcis:EPCISDocument xmlns:cbvmda="urn:epcglobal:cbv:mda"
xmlns:sbdh="http://www.unece.org/cefact/namespaces/StandardBusinessDocumentHeader"
xmlns:gslushc="http://epcis.gslus.org/hc/ns" xmlns:epcis="urn:epcglobal:epcis:xsd:1"
schemaVersion="1.2" xsi:schemaLocation="urn:epcglobal:epcis:xsd:1 EPCglobal-epcis-1_2.xsd"
xmlns:xsi="http://www.w3.org/2001/XMLSchema-instance" creationDate="2014-04-02T15:14:27.574-
04:00">
  <EPCISHeader>
    <sbdh:StandardBusinessDocumentHeader>
      <sbdh:HeaderVersion>1.0</sbdh:HeaderVersion>
      <sbdh:Sender>
        <sbdh:Identifier
Authority="SGLN">urn:epc:id:sgln:0614141.00000.0</sbdh:Identifier>
        </sbdh:Sender>
      <sbdh:Receiver>
        <sbdh:Identifier
Authority="SGLN">urn:epc:id:sgln:0614141.11111.0</sbdh:Identifier>
        </sbdh:Receiver>
      <sbdh:DocumentIdentification>
        <sbdh:Standard>EPCglobal</sbdh:Standard>
        <sbdh:TypeVersion>1.0</sbdh:TypeVersion>
        <sbdh:InstanceIdentifier>1234567851</sbdh:InstanceIdentifier>
        <sbdh:Type>Events</sbdh:Type>
        <sbdh:CreationDateAndTime>2014-04-02T15:14:27.574-04:00</sbdh:CreationDateAndTime>
      </sbdh:DocumentIdentification>
    </sbdh:StandardBusinessDocumentHeader>
    <extension>
      <EPCISMasterData>
        <VocabularyList>
          <Vocabulary type="urn:epcglobal:epcis:vtype:EPCClass">
            <VocabularyElementList>
              <VocabularyElement id="urn:epc:class:lgtn:030000.0000001.L1">
                <attribute id="urn:epcglobal:cbv:mda#itemExpirationDate">2017-10-
31</attribute>
              </VocabularyElement>
              <VocabularyElement id="urn:epc:idpat:sgtin:030000.0000001.*">
                <attribute
id="urn:epcglobal:cbv:mda#additionalTradeItemIdentification">0000000001</attribute>
                <attribute
id="urn:epcglobal:cbv:mda#additionalTradeItemIdentificationTypeCode">FDA_NDC_11</attribute>
                <attribute
id="urn:epcglobal:cbv:mda#regulatedProductName">Epcistra</attribute>
                <attribute
id="urn:epcglobal:cbv:mda#manufacturerOfTradeItemPartyName">GS1 Pharma LLC</attribute>
                <attribute id="urn:epcglobal:cbv:mda#dosageFormType">PILL</attribute>
                <attribute
id="urn:epcglobal:cbv:mda#strengthDescription">100mg</attribute>
                <attribute id="urn:epcglobal:cbv:mda#netContentDescription">500
pills</attribute>
              </VocabularyElement>
            </VocabularyElementList>
          </Vocabulary>
          <Vocabulary type="urn:epcglobal:epcis:vtype:Location">
            <VocabularyElementList>
              <VocabularyElement id="urn:epc:id:sgln:030000.000000.0">
                <attribute id="urn:epcglobal:cbv:mda#name">GS1 Pharma LLC</attribute>

```

```

        <attribute id="urn:epcglobal:cbv:mda#streetAddressOne">1295 S George
Ave</attribute>
        <attribute id="urn:epcglobal:cbv:mda#streetAddressTwo">Room
378</attribute>
        <attribute id="urn:epcglobal:cbv:mda#city">Washington</attribute>
        <attribute id="urn:epcglobal:cbv:mda#state">DC</attribute>
        <attribute id="urn:epcglobal:cbv:mda#postalCode">12345-
6789</attribute>
        <attribute id="urn:epcglobal:cbv:mda#countryCode">US</attribute>
</VocabularyElement>
<VocabularyElement id="urn:epc:id:sgln:0614141.00000.0">
    <attribute id="urn:epcglobal:cbv:mda#name">GS1 Drug Distro
LLC</attribute>
    <attribute id="urn:epcglobal:cbv:mda#streetAddressOne">230 Park Ave
S</attribute>
    <attribute id="urn:epcglobal:cbv:mda#city">New York</attribute>
    <attribute id="urn:epcglobal:cbv:mda#state">NY</attribute>
    <attribute id="urn:epcglobal:cbv:mda#postalCode">10003-
1502</attribute>
    <attribute id="urn:epcglobal:cbv:mda#countryCode">US</attribute>
</VocabularyElement>
</VocabularyElementList>
</Vocabulary>
</VocabularyList>
</EPCISMasterData>
</extension>
</EPCISHeader>
<EPCISBody>
    <EventList>
        <!-- 9 cases are received into inventory -->
        <ObjectEvent>
            <eventTime>2014-04-02T10:11:12Z</eventTime>
            <eventTimeZoneOffset>-05:00</eventTimeZoneOffset>
            <epcList/>
            <action>OBSERVE</action>
            <bizStep>urn:epcglobal:cbv:bizstep:receiving</bizStep>
            <disposition>urn:epcglobal:cbv:disp:in_progress</disposition>
            <readPoint>
                <id>urn:epc:id:sgln:0614141.00000.0</id>
            </readPoint>
            <extension>
                <quantityList>
                    <!-- In this example, the EPCIS quantityElement data structure contains the
lgtin for the lowest saleable unit (LSU) and the quantity value is given in terms of LSUs. For
this example scenario, each ordered case contains 12 LSUs. Hence, the quantity value will be
computed by multiplying the order case quantity with 12 LSUs. -->
                    <quantityElement>
                        <epcClass>urn:epc:class:lgtin:030000.0000001.L1</epcClass>
                        <quantity>108</quantity>
                    </quantityElement>
                </quantityList>
                <sourceList>
                    <source
type="urn:epcglobal:cbv:sdt:owning_party">urn:epc:id:sgln:030000.000000.0</source>
                    </sourceList>
                <destinationList>
                    <destination
type="urn:epcglobal:cbv:sdt:owning_party">urn:epc:id:sgln:0614141.00000.0</destination>
                    </destinationList>
                </extension>
            </ObjectEvent>

```

```

<!-- 1 damaged case is received with status of damaged -->
<ObjectEvent>
  <eventTime>2014-04-02T10:12:12Z</eventTime>
  <eventTimeZoneOffset>-05:00</eventTimeZoneOffset>
  <epcList/>
  <action>OBSERVE</action>
  <bizStep>urn:epcglobal:cbv:bizstep:receiving</bizStep>
  <disposition>urn:epcglobal:cbv:disp:damaged</disposition>
  <readPoint>
    <id>urn:epc:id:sgln:0614141.00000.0</id>
  </readPoint>
  <extension>
    <quantityList>
      <!-- In this example, the EPCIS quantityElement data structure contains the
lgtin for the lowest saleable unit (LSU) and the quantity value is given in terms of LSUs. For
this example scenario, each ordered case contains 12 LSUs. Hence, the quantity value will be
computed by multiplying the order case quantity with 12 LSUs. -->
      <quantityElement>
        <epcClass>urn:epc:class:lgtin:030000.0000001.L1</epcClass>
        <quantity>12</quantity>
      </quantityElement>
    </quantityList>
    <sourceList>
      <source
type="urn:epcglobal:cbv:sdt:owning_party">urn:epc:id:sgln:030000.000000.0</source>
    </sourceList>
    <destinationList>
      <destination
type="urn:epcglobal:cbv:sdt:owning_party">urn:epc:id:sgln:0614141.00000.0</destination>
    </destinationList>
  </extension>
</ObjectEvent>
</EventList>
</EPCISBody>
</epcis:EPCISDocument>

```

### 12.9.2.3 Sample XML: Buyer Destroys Damaged Product

Reference File: <https://resources.gs1us.org/Portals/0/xml/LotException-DamagedShipmentDestroy-BuyerDestroysDamagedProduct.xml>

```

<?xml version="1.0" encoding="UTF-8"?>
<!-- Lot Exception: DAMAGE SHIPMENT (DAMAGED PRODUCT IS DESTROYED) - Buyer Destroys Product --
>
<!-- After buyer notifies seller of the 1 damaged case that arrived at the buyer warehouse, the
seller authorizes buyer to destroy damaged product -->
<epcis:EPCISDocument xmlns:cbvmda="urn:epcglobal:cbv:mda"
xmlns:sbdh="http://www.unece.org/cefact/namespaces/StandardBusinessDocumentHeader"
xmlns:gslushc="http://epcis.gs1us.org/hc/ns" xmlns:epcis="urn:epcglobal:epcis:xsd:1"
schemaVersion="1.2" xsi:schemaLocation="urn:epcglobal:epcis:xsd:1 EPCglobal-epcis-1_2.xsd"
xmlns:xsi="http://www.w3.org/2001/XMLSchema-instance" creationDate="2014-04-03T15:14:27.574-
04:00">
  <EPCISHeader>
    <sbdh:StandardBusinessDocumentHeader>
      <sbdh:HeaderVersion>1.0</sbdh:HeaderVersion>
      <sbdh:Sender>
        <sbdh:Identifier
Authority="SGLN">urn:epc:id:sgln:0614141.00000.0</sbdh:Identifier>
      </sbdh:Sender>
      <sbdh:Receiver>

```

```

        <sbdh:Identifier
Authority="SGLN">urn:epc:id:sgln:0614141.11111.0</sbdh:Identifier>
    </sbdh:Receiver>
    <sbdh:DocumentIdentification>
        <sbdh:Standard>EPCglobal</sbdh:Standard>
        <sbdh:TypeVersion>1.0</sbdh:TypeVersion>
        <sbdh:InstanceIdentifier>1234567854</sbdh:InstanceIdentifier>
        <sbdh:Type>Events</sbdh:Type>
        <sbdh:CreationDateAndTime>2014-04-03T15:14:27.574-04:00</sbdh:CreationDateAndTime>
    </sbdh:DocumentIdentification>
</sbdh:StandardBusinessDocumentHeader>
<extension>
    <EPCISMasterData>
        <VocabularyList>
            <Vocabulary type="urn:epcglobal:epcis:vtype:EPCClass">
                <VocabularyElementList>
                    <VocabularyElement id="urn:epc:class:lgtin:030000.0000001.L1">
                        <attribute id="urn:epcglobal:cbv:mda#itemExpirationDate">2017-10-
31</attribute>
                    </VocabularyElement>
                    <VocabularyElement id="urn:epc:idpat:sgtin:030000.0000001.*">
                        <attribute
id="urn:epcglobal:cbv:mda#additionalTradeItemIdentification">0000000001</attribute>
                        <attribute
id="urn:epcglobal:cbv:mda#additionalTradeItemIdentificationTypeCode">FDA_NDC_11</attribute>
                        <attribute
id="urn:epcglobal:cbv:mda#regulatedProductName">Epcistra</attribute>
                        <attribute
id="urn:epcglobal:cbv:mda#manufacturerOfTradeItemPartyName">GS1 Pharma LLC</attribute>
                        <attribute id="urn:epcglobal:cbv:mda#dosageFormType">PILL</attribute>
                        <attribute
id="urn:epcglobal:cbv:mda#strengthDescription">100mg</attribute>
                        <attribute id="urn:epcglobal:cbv:mda#netContentDescription">500
pills</attribute>
                    </VocabularyElement>
                </VocabularyElementList>
            </Vocabulary>
            <Vocabulary type="urn:epcglobal:epcis:vtype:Location">
                <VocabularyElementList>
                    <VocabularyElement id="urn:epc:id:sgln:030000.000000.0">
                        <attribute id="urn:epcglobal:cbv:mda#name">GS1 Pharma LLC</attribute>
                        <attribute id="urn:epcglobal:cbv:mda#streetAddressOne">1295 S George
Ave</attribute>
                        <attribute id="urn:epcglobal:cbv:mda#streetAddressTwo">Room
378</attribute>
                        <attribute id="urn:epcglobal:cbv:mda#city">Washington</attribute>
                        <attribute id="urn:epcglobal:cbv:mda#state">DC</attribute>
                        <attribute id="urn:epcglobal:cbv:mda#postalCode">12345-
6789</attribute>
                        <attribute id="urn:epcglobal:cbv:mda#countryCode">US</attribute>
                    </VocabularyElement>
                    <VocabularyElement id="urn:epc:id:sgln:0614141.00000.0">
                        <attribute id="urn:epcglobal:cbv:mda#name">GS1 Drug Distro
LLC</attribute>
                        <attribute id="urn:epcglobal:cbv:mda#streetAddressOne">230 Park Ave
S</attribute>
                        <attribute id="urn:epcglobal:cbv:mda#city">New York</attribute>
                        <attribute id="urn:epcglobal:cbv:mda#state">NY</attribute>
                        <attribute id="urn:epcglobal:cbv:mda#postalCode">10003-
1502</attribute>
                        <attribute id="urn:epcglobal:cbv:mda#countryCode">US</attribute>

```

```

        </VocabularyElement>
      </VocabularyElementList>
    </Vocabulary>
  </VocabularyList>
</EPCISMasterData>
</extension>
</EPCISHeader>
<EPCISBody>
  <EventList>
    <!-- 1 damaged case is destroyed -->
    <ObjectEvent>
      <eventTime>2014-04-03T10:11:12Z</eventTime>
      <eventTimeZoneOffset>-05:00</eventTimeZoneOffset>
      <epcList/>
      <action>DELETE</action>
      <bizStep>urn:epcglobal:cbv:bizstep:destroying</bizStep>
      <disposition>urn:epcglobal:cbv:disp:destroyed</disposition>
      <readPoint>
        <id>urn:epc:id:sgln:0614141.00000.0</id>
      </readPoint>
      <extension>
        <quantityList>
          <!-- In this example, the EPCIS quantityElement data structure contains the
lgtin for the lowest saleable unit (LSU) and the quantity value is given in terms of LSUs. For
this example scenario, each ordered case contains 12 LSUs. Hence, the quantity value will be
computed by multiplying the order case quantity with 12 LSUs. -->
          <quantityElement>
            <epcClass>urn:epc:class:lgtin:030000.0000001.L1</epcClass>
            <quantity>12</quantity>
          </quantityElement>
        </quantityList>
      </extension>
    </ObjectEvent>
  </EventList>
</EPCISBody>
</epcis:EPCISDocument>

```

## 12.10 Incomplete DSCSA Data

### 12.10.1 Sample XML: Exchange1 - Seller → Buyer

Reference File: <https://resources.gs1us.org/Portals/0/xml/LotException-IncompleteDSCSAData-SellerExchange1.xml>

```
<?xml version="1.0" encoding="UTF-8"?>
<!-- Lot Exception: INCOMPLETE DSCSA DATA - Exchange1: Seller -> Buyer-->
<!--Seller ships correct shipment and amounts to Buyer; however, not all DSCSA-required data
was passed. -->
<epcis:EPCISDocument xmlns:cbvmda="urn:epcglobal:cbv:mda"
xmlns:sbdh="http://www.unece.org/cefact/namespaces/StandardBusinessDocumentHeader"
xmlns:gslushc="http://epcis.gs1us.org/hc/ns" xmlns:epcis="urn:epcglobal:epcis:xsd:1"
schemaVersion="1.2" xsi:schemaLocation="urn:epcglobal:epcis:xsd:1 EPCglobal-epcis-1_2.xsd"
xmlns:xsi="http://www.w3.org/2001/XMLSchema-instance" creationDate="2014-04-01T15:14:27.574-
04:00">
  <EPCISHeader>
    <sbdh:StandardBusinessDocumentHeader>
      <sbdh:HeaderVersion>1.0</sbdh:HeaderVersion>
      <sbdh:Sender>
        <sbdh:Identifier
Authority="SGLN">urn:epc:id:sgln:030000.000000.0</sbdh:Identifier>
        </sbdh:Sender>
      <sbdh:Receiver>
        <sbdh:Identifier
Authority="SGLN">urn:epc:id:sgln:0614141.00000.0</sbdh:Identifier>
        </sbdh:Receiver>
      <sbdh:DocumentIdentification>
        <sbdh:Standard>EPCglobal</sbdh:Standard>
        <sbdh:TypeVersion>1.0</sbdh:TypeVersion>
        <sbdh:InstanceIdentifier>1234567855</sbdh:InstanceIdentifier>
        <sbdh:Type>Events</sbdh:Type>
        <sbdh:CreationDateAndTime>2014-04-01T15:14:27.574-04:00</sbdh:CreationDateAndTime>
      </sbdh:DocumentIdentification>
    </sbdh:StandardBusinessDocumentHeader>
    <extension>
      <EPCISMasterData>
        <VocabularyList>
          <Vocabulary type="urn:epcglobal:epcis:vtype:EPCClass">
            <VocabularyElementList>
              <VocabularyElement id="urn:epc:class:lgtn:030000.0000001.L1">
                <attribute id="urn:epcglobal:cbv:mda#itemExpirationDate">2017-10-
31</attribute>
              </VocabularyElement>
              <VocabularyElement id="urn:epc:idpat:sgtin:030000.0000001.*">
                <attribute
id="urn:epcglobal:cbv:mda#additionalTradeItemIdentification">0000000001</attribute>
                <attribute
id="urn:epcglobal:cbv:mda#additionalTradeItemIdentificationTypeCode">FDA_NDC_11</attribute>
                <attribute
id="urn:epcglobal:cbv:mda#regulatedProductName">Epcistra</attribute>
                <attribute
id="urn:epcglobal:cbv:mda#manufacturerOfTradeItemPartyName">GS1 Pharma LLC</attribute>
                <attribute id="urn:epcglobal:cbv:mda#dosageFormType">PILL</attribute>
                <attribute
id="urn:epcglobal:cbv:mda#strengthDescription">100mg</attribute>
                <attribute id="urn:epcglobal:cbv:mda#netContentDescription">500
pills</attribute>
              </VocabularyElement>
            </VocabularyElementList>
          </Vocabulary>
        </VocabularyList>
      </EPCISMasterData>
    </extension>
  </EPCISHeader>
</epcis:EPCISDocument>
```

```

        </VocabularyElementList>
    </Vocabulary>
    <Vocabulary type="urn:epcglobal:epcis:vtype:Location">
        <VocabularyElementList>
            <VocabularyElement id="urn:epc:id:sgln:030000.000000.0">
                <attribute id="urn:epcglobal:cbv:mda#name">GS1 Pharma LLC</attribute>
                <attribute id="urn:epcglobal:cbv:mda#streetAddressOne">1295 S George
Ave</attribute>
                <attribute id="urn:epcglobal:cbv:mda#streetAddressTwo">Room
378</attribute>
                <attribute id="urn:epcglobal:cbv:mda#city">Washington</attribute>
                <attribute id="urn:epcglobal:cbv:mda#state">DC</attribute>
                <attribute id="urn:epcglobal:cbv:mda#postalCode">12345-
6789</attribute>
                <attribute id="urn:epcglobal:cbv:mda#countryCode">US</attribute>
            </VocabularyElement>
            <VocabularyElement id="urn:epc:id:sgln:0614141.00000.0">
                <!-- Location Master Data mistakenly omits the Buyer's Company Name -
->
                <attribute id="urn:epcglobal:cbv:mda#streetAddressOne">230 Park Ave
S</attribute>
                <attribute id="urn:epcglobal:cbv:mda#city">New York</attribute>
                <attribute id="urn:epcglobal:cbv:mda#state">NY</attribute>
                <attribute id="urn:epcglobal:cbv:mda#postalCode">10003-
1502</attribute>
                <attribute id="urn:epcglobal:cbv:mda#countryCode">US</attribute>
            </VocabularyElement>
        </VocabularyElementList>
    </Vocabulary>
</VocabularyList>
</EPCISMasterData>
</extension>
<gslushc:dscsaTransactionStatement>
    <gslushc:affirmTransactionStatement>true</gslushc:affirmTransactionStatement>
    <gslushc:legalNotice>Seller has complied with each applicable subsection of FDCA Sec.
581 (27) (A) - (G).</gslushc:legalNotice>
</gslushc:dscsaTransactionStatement>
</EPCISHeader>
<EPCISBody>
    <EventList>
        <!-- Transaction Information (TI) -->
        <ObjectEvent>
            <eventTime>2014-04-01T10:11:12Z</eventTime>
            <eventTimeZoneOffset>-05:00</eventTimeZoneOffset>
            <epcList/>
            <action>OBSERVE</action>
            <bizStep>urn:epcglobal:cbv:bizstep:shipping</bizStep>
            <disposition>urn:epcglobal:cbv:disp:in_transit</disposition>
            <readPoint>
                <id>urn:epc:id:sgln:030000.000000.0</id>
            </readPoint>
            <extension>
                <quantityList>
                    <!-- In this example, the EPCIS quantityElement data structure contains the
lgtin for the lowest saleable unit (LSU) and the quantity value is given in terms of LSUs. For
this example scenario, each ordered case contains 12 LSUs. Hence, the quantity value will be
computed by multiplying the order case quantity with 12 LSUs. -->
                    <quantityElement>
                        <epcClass>urn:epc:class:lgtin:030000.0000001.L1</epcClass>
                        <quantity>120</quantity>
                    </quantityElement>
                </quantityList>
            </extension>
        </ObjectEvent>
    </EventList>
</EPCISBody>
</EPCIS>

```



```

        </quantityList>
        <sourceList>
          <source
type="urn:epcglobal:cbv:sdt:owning_party">urn:epc:id:sgln:030000.000000.0</source>
        </sourceList>
        <destinationList>
          <destination
type="urn:epcglobal:cbv:sdt:owning_party">urn:epc:id:sgln:0614141.00000.0</destination>
        </destinationList>
      </extension>
    </ObjectEvent>
  </EventList>
</EPCISBody>
</epcis:EPCISDocument>

```

### 12.10.2 Sample XML: Seller Corrects Shipment Data

Reference File: <https://resources.gs1us.org/Portals/0/xml/LotException-IncompleteDSCSAData-SellerCorrectsShipmentData.xml>

```

<?xml version="1.0" encoding="UTF-8"?>
<!-- Lot Exception: INCOMPLETE DSCSA DATA - Seller corrects shipment data -->
<!-- Seller investigates discrepancy and resolves issue by generating voidShipping event for
the previously generated shipping event which omitted the Buyer Company Name -->
<epcis:EPCISDocument xmlns:cbvmda="urn:epcglobal:cbv:mda"
xmlns:sbdh="http://www.unece.org/cefact/namespaces/StandardBusinessDocumentHeader"
xmlns:gslushc="http://epcis.gs1us.org/hc/ns" xmlns:epcis="urn:epcglobal:epcis:xsd:1"
schemaVersion="1.2" xsi:schemaLocation="urn:epcglobal:epcis:xsd:1 EPCglobal-epcis-1_2.xsd"
xmlns:xsi="http://www.w3.org/2001/XMLSchema-instance" creationDate="2014-04-03T15:14:27.574-
04:00">
  <EPCISHeader>
    <sbdh:StandardBusinessDocumentHeader>
      <sbdh:HeaderVersion>1.0</sbdh:HeaderVersion>
      <sbdh:Sender>
        <sbdh:Identifier
Authority="SGLN">urn:epc:id:sgln:030000.000000.0</sbdh:Identifier>
      </sbdh:Sender>
      <sbdh:Receiver>
        <sbdh:Identifier
Authority="SGLN">urn:epc:id:sgln:030000.000001.0</sbdh:Identifier>
      </sbdh:Receiver>
      <sbdh:DocumentIdentification>
        <sbdh:Standard>EPCglobal</sbdh:Standard>
        <sbdh:TypeVersion>1.0</sbdh:TypeVersion>
        <sbdh:InstanceIdentifier>1234567856</sbdh:InstanceIdentifier>
        <sbdh:Type>Events</sbdh:Type>
        <sbdh:CreationDateAndTime>2014-04-03T15:14:27.574-04:00</sbdh:CreationDateAndTime>
      </sbdh:DocumentIdentification>
    </sbdh:StandardBusinessDocumentHeader>
    <extension>
      <EPCISMasterData>
        <VocabularyList>
          <Vocabulary type="urn:epcglobal:epcis:vtype:EPCClass">
            <VocabularyElementList>
              <VocabularyElement id="urn:epc:class:lgtn:030000.0000001.L1">
                <attribute id="urn:epcglobal:cbv:mda:itemExpirationDate">2017-10-
31</attribute>
              </VocabularyElement>
              <VocabularyElement id="urn:epc:idpat:sgtin:030000.0000001.*">

```

```

        <attribute
id="urn:epcglobal:cbv:mda#additionalTradeItemIdentification">00000000001</attribute>
        <attribute
id="urn:epcglobal:cbv:mda#additionalTradeItemIdentificationTypeCode">FDA_NDC_11</attribute>
        <attribute
id="urn:epcglobal:cbv:mda#regulatedProductName">Epcistra</attribute>
        <attribute
id="urn:epcglobal:cbv:mda#manufacturerOfTradeItemPartyName">GS1 Pharma LLC</attribute>
        <attribute id="urn:epcglobal:cbv:mda#dosageFormType">PILL</attribute>
        <attribute
id="urn:epcglobal:cbv:mda#strengthDescription">100mg</attribute>
        <attribute id="urn:epcglobal:cbv:mda#netContentDescription">500
pills</attribute>
    </VocabularyElement>
</VocabularyElementList>
</Vocabulary>
<Vocabulary type="urn:epcglobal:epcis:vtype:Location">
    <VocabularyElementList>
        <VocabularyElement id="urn:epc:id:sgln:030000.000000.0">
            <attribute id="urn:epcglobal:cbv:mda#name">GS1 Pharma LLC</attribute>
            <attribute id="urn:epcglobal:cbv:mda#streetAddressOne">1295 S George
Ave</attribute>
            <attribute id="urn:epcglobal:cbv:mda#streetAddressTwo">Room
378</attribute>
            <attribute id="urn:epcglobal:cbv:mda#city">Washington</attribute>
            <attribute id="urn:epcglobal:cbv:mda#state">DC</attribute>
            <attribute id="urn:epcglobal:cbv:mda#postalCode">12345-
6789</attribute>
            <attribute id="urn:epcglobal:cbv:mda#countryCode">US</attribute>
        </VocabularyElement>
        <VocabularyElement id="urn:epc:id:sgln:0614141.00000.0">
            <!-- Location Master Data mistakenly omits the Buyer's Company Name -
->
            <attribute id="urn:epcglobal:cbv:mda#streetAddressOne">230 Park Ave
S</attribute>
            <attribute id="urn:epcglobal:cbv:mda#city">New York</attribute>
            <attribute id="urn:epcglobal:cbv:mda#state">NY</attribute>
            <attribute id="urn:epcglobal:cbv:mda#postalCode">10003-
1502</attribute>
            <attribute id="urn:epcglobal:cbv:mda#countryCode">US</attribute>
        </VocabularyElement>
    </VocabularyElementList>
</Vocabulary>
</VocabularyList>
</EPCISMasterData>
</extension>
</EPCISHeader>
<EPCISBody>
    <EventList>
        <ObjectEvent>
            <eventTime>2014-04-03T10:11:12Z</eventTime>
            <eventTimeZoneOffset>-05:00</eventTimeZoneOffset>
            <epcList/>
            <action>OBSERVE</action>
            <bizStep>urn:epcglobal:cbv:bizstep:void_shipping</bizStep>
            <disposition>urn:epcglobal:cbv:disp:in_progress</disposition>
            <readPoint>
                <id>urn:epc:id:sgln:030000.000000.0</id>
            </readPoint>
            <extension>
                <quantityList>

```

```

        <!-- In this example, the EPCIS quantityElement data structure contains the
lgtn for the lowest saleable unit (LSU) and the quantity value is given in terms of LSUs. For
this example scenario, each ordered case contains 12 LSUs. Hence, the quantity value will be
computed by multiplying the order case quantity with 12 LSUs. -->
        <quantityElement>
            <epcClass>urn:epc:class:lgtn:030000.0000001.L1</epcClass>
            <quantity>120</quantity>
        </quantityElement>
    </quantityList>
    <sourceList>
        <source
type="urn:epcglobal:cbv:sdt:owning_party">urn:epc:id:sgln:030000.000000.0</source>
    </sourceList>
    <destinationList>
        <destination
type="urn:epcglobal:cbv:sdt:owning_party">urn:epc:id:sgln:0614141.00000.0</destination>
    </destinationList>
</extension>
</ObjectEvent>
</EventList>
</EPCISBody>
</epcis:EPCISDocument>

```

### 12.10.3 Sample XML: Exchange2 - Seller → Buyer

Reference File: <https://resources.gs1us.org/Portals/0/xml/LotException-IncompleteDSCSAData-SellerExchange2.xml>

```

<?xml version="1.0" encoding="UTF-8"?>
<!-- Lot Exception: INCOMPLETE DSCSA DATA - Exchange2: Seller -> Buyer-->
<!-- Seller resolves incomplete shipping event data by generating new shipping event with
required supporting DSCSA information -->
<epcis:EPCISDocument xmlns:cbvmda="urn:epcglobal:cbv:mda"
xmlns:sbdh="http://www.unece.org/cefact/namespaces/StandardBusinessDocumentHeader"
xmlns:gslushc="http://epcis.gs1us.org/hc/ns" xmlns:epcis="urn:epcglobal:epcis:xsd:1"
schemaVersion="1.2" xsi:schemaLocation="urn:epcglobal:epcis:xsd:1 EPCglobal-epcis-1_2.xsd"
xmlns:xsi="http://www.w3.org/2001/XMLSchema-instance" creationDate="2014-04-04T15:14:27.574-
04:00">
    <EPCISHeader>
        <sbdh:StandardBusinessDocumentHeader>
            <sbdh:HeaderVersion>1.0</sbdh:HeaderVersion>
            <sbdh:Sender>
                <sbdh:Identifier
Authority="SGLN">urn:epc:id:sgln:030000.000000.0</sbdh:Identifier>
            </sbdh:Sender>
            <sbdh:Receiver>
                <sbdh:Identifier
Authority="SGLN">urn:epc:id:sgln:0614141.00000.0</sbdh:Identifier>
            </sbdh:Receiver>
            <sbdh:DocumentIdentification>
                <sbdh:Standard>EPCglobal</sbdh:Standard>
                <sbdh:TypeVersion>1.0</sbdh:TypeVersion>
                <sbdh:InstanceIdentifier>1234567857</sbdh:InstanceIdentifier>
                <sbdh:Type>Events</sbdh:Type>
                <sbdh:CreationDateAndTime>2014-04-04T15:14:27.574-04:00</sbdh:CreationDateAndTime>
            </sbdh:DocumentIdentification>
        </sbdh:StandardBusinessDocumentHeader>
    <extension>
        <EPCISMasterData>
            <VocabularyList>

```

```

    <Vocabulary type="urn:epcglobal:epcis:vtype:EPCClass">
      <VocabularyElementList>
        <VocabularyElement id="urn:epc:class:lgtn:030000.0000001.L1">
          <attribute id="urn:epcglobal:cbv:mda#itemExpirationDate">2017-10-
31</attribute>
          </VocabularyElement>
          <VocabularyElement id="urn:epc:idpat:sgtin:030000.0000001.*">
            <attribute
id="urn:epcglobal:cbv:mda#additionalTradeItemIdentification">00000000001</attribute>
            <attribute
id="urn:epcglobal:cbv:mda#additionalTradeItemIdentificationTypeCode">FDA_NDC_11</attribute>
            <attribute
id="urn:epcglobal:cbv:mda#regulatedProductName">Epcistra</attribute>
            <attribute
id="urn:epcglobal:cbv:mda#manufacturerOfTradeItemPartyName">GS1 Pharma LLC</attribute>
            <attribute id="urn:epcglobal:cbv:mda#dosageFormType">PILL</attribute>
            <attribute
id="urn:epcglobal:cbv:mda#strengthDescription">100mg</attribute>
            <attribute id="urn:epcglobal:cbv:mda#netContentDescription">500
pills</attribute>
          </VocabularyElement>
        </VocabularyElementList>
      </Vocabulary>
      <Vocabulary type="urn:epcglobal:epcis:vtype:Location">
        <VocabularyElementList>
          <VocabularyElement id="urn:epc:id:sgln:030000.000000.0">
            <attribute id="urn:epcglobal:cbv:mda#name">GS1 Pharma LLC</attribute>
            <attribute id="urn:epcglobal:cbv:mda#streetAddressOne">1295 S George
Ave</attribute>
            <attribute id="urn:epcglobal:cbv:mda#streetAddressTwo">Room
378</attribute>
            <attribute id="urn:epcglobal:cbv:mda#city">Washington</attribute>
            <attribute id="urn:epcglobal:cbv:mda#state">DC</attribute>
            <attribute id="urn:epcglobal:cbv:mda#postalCode">12345-
6789</attribute>
            <attribute id="urn:epcglobal:cbv:mda#countryCode">US</attribute>
          </VocabularyElement>
          <VocabularyElement id="urn:epc:id:sgln:0614141.00000.0">
            <!-- Location Master Data is updated to include the Buyer's Company
Name -->
            <attribute id="urn:epcglobal:cbv:mda#name">GS1 Drug Distro
LLC</attribute>
            <attribute id="urn:epcglobal:cbv:mda#streetAddressOne">230 Park Ave
S</attribute>
            <attribute id="urn:epcglobal:cbv:mda#city">New York</attribute>
            <attribute id="urn:epcglobal:cbv:mda#state">NY</attribute>
            <attribute id="urn:epcglobal:cbv:mda#postalCode">10003-
1502</attribute>
            <attribute id="urn:epcglobal:cbv:mda#countryCode">US</attribute>
          </VocabularyElement>
        </VocabularyElementList>
      </Vocabulary>
    </VocabularyList>
  </EPCISMasterData>
</extension>
<gslushc:dscsaTransactionStatement>
  <gslushc:affirmTransactionStatement>true</gslushc:affirmTransactionStatement>
  <gslushc:legalNotice>Seller has complied with each applicable subsection of FDCA Sec.
581 (27) (A) - (G).</gslushc:legalNotice>
</gslushc:dscsaTransactionStatement>
</EPCISHeader>

```

```

<EPCISBody>
  <EventList>
    <!-- Transaction Information (TI) -->
    <ObjectEvent>
      <eventTime>2014-04-01T10:11:12Z</eventTime>
      <eventTimeZoneOffset>-05:00</eventTimeZoneOffset>
      <epcList/>
      <action>OBSERVE</action>
      <bizStep>urn:epcglobal:cbv:bizstep:shipping</bizStep>
      <disposition>urn:epcglobal:cbv:disp:in_transit</disposition>
      <readPoint>
        <id>urn:epc:id:sgln:030000.000000.0</id>
      </readPoint>
      <extension>
        <quantityList>
          <!-- In this example, the EPCIS quantityElement data structure contains the
lgtin for the lowest saleable unit (LSU) and the quantity value is given in terms of LSUs. For
this example scenario, each ordered case contains 12 LSUs. Hence, the quantity value will be
computed by multiplying the order case quantity with 12 LSUs. -->
          <quantityElement>
            <epcClass>urn:epc:class:lgtin:030000.0000001.L1</epcClass>
            <quantity>120</quantity>
          </quantityElement>
        </quantityList>
        <sourceList>
          <source
type="urn:epcglobal:cbv:sdt:owning_party">urn:epc:id:sgln:030000.000000.0</source>
        </sourceList>
        <destinationList>
          <destination
type="urn:epcglobal:cbv:sdt:owning_party">urn:epc:id:sgln:0614141.00000.0</destination>
        </destinationList>
      </extension>
    </ObjectEvent>
  </EventList>
</EPCISBody>
</epcis:EPCISDocument>

```

#### 12.10.4 Sample XML: Buyer Receives Product

Reference File: <https://resources.gs1us.org/Portals/0/xml/LotException-IncompleteDSCSAData-BuyerReceives.xml>

```

<?xml version="1.0" encoding="UTF-8"?>
<!-- Lot Exception: INCOMPLETE DSCSA DATA - Buyer Receives Product -->
<!-- Buyer receives 10 cases with supporting DSCSA data -->
<epcis:EPCISDocument xmlns:cbvmda="urn:epcglobal:cbv:mda"
xmlns:sbdh="http://www.unece.org/cefact/namespaces/StandardBusinessDocumentHeader"
xmlns:gslushc="http://epcis.gs1us.org/hc/ns" xmlns:epcis="urn:epcglobal:epcis:xsd:1"
schemaVersion="1.2" xsi:schemaLocation="urn:epcglobal:epcis:xsd:1 EPCglobal-epcis-1_2.xsd"
xmlns:xsi="http://www.w3.org/2001/XMLSchema-instance" creationDate="2014-04-05T15:14:27.574-
04:00">
  <EPCISHeader>
    <sbdh:StandardBusinessDocumentHeader>
      <sbdh:HeaderVersion>1.0</sbdh:HeaderVersion>
      <sbdh:Sender>
        <sbdh:Identifier
Authority="SGLN">urn:epc:id:sgln:0614141.00000.0</sbdh:Identifier>
      </sbdh:Sender>
      <sbdh:Receiver>

```

```

    <sbdh:Identifier
Authority="SGLN">urn:epc:id:sgln:0614141.11111.0</sbdh:Identifier>
  </sbdh:Receiver>
  <sbdh:DocumentIdentification>
    <sbdh:Standard>EPCglobal</sbdh:Standard>
    <sbdh:TypeVersion>1.0</sbdh:TypeVersion>
    <sbdh:InstanceIdentifier>1234567858</sbdh:InstanceIdentifier>
    <sbdh:Type>Events</sbdh:Type>
    <sbdh:CreationDateAndTime>2014-04-05T15:14:27.574-04:00</sbdh:CreationDateAndTime>
  </sbdh:DocumentIdentification>
</sbdh:StandardBusinessDocumentHeader>
<extension>
  <EPCISMasterData>
    <VocabularyList>
      <Vocabulary type="urn:epcglobal:epcis:vtype:EPCClass">
        <VocabularyElementList>
          <VocabularyElement id="urn:epc:class:lgtin:030000.0000001.L1">
            <attribute id="urn:epcglobal:cbv:mda#itemExpirationDate">2017-10-
31</attribute>
              </VocabularyElement>
            <VocabularyElement id="urn:epc:idpat:sgtin:030000.0000001.*">
              <attribute
id="urn:epcglobal:cbv:mda#additionalTradeItemIdentification">0000000001</attribute>
                <attribute
id="urn:epcglobal:cbv:mda#additionalTradeItemIdentificationTypeCode">FDA_NDC_11</attribute>
                  <attribute
id="urn:epcglobal:cbv:mda#regulatedProductName">Epcistra</attribute>
                    <attribute
id="urn:epcglobal:cbv:mda#manufacturerOfTradeItemPartyName">GS1 Pharma LLC</attribute>
                      <attribute id="urn:epcglobal:cbv:mda#dosageFormType">PILL</attribute>
                        <attribute
id="urn:epcglobal:cbv:mda#strengthDescription">100mg</attribute>
                          <attribute id="urn:epcglobal:cbv:mda#netContentDescription">500
pills</attribute>
                            </VocabularyElement>
                          </VocabularyElementList>
                        </Vocabulary>
                      <Vocabulary type="urn:epcglobal:epcis:vtype:Location">
                        <VocabularyElementList>
                          <VocabularyElement id="urn:epc:id:sgln:030000.000000.0">
                            <attribute id="urn:epcglobal:cbv:mda#name">GS1 Pharma LLC</attribute>
                              <attribute id="urn:epcglobal:cbv:mda#streetAddressOne">1295 S George
Ave</attribute>
                                <attribute id="urn:epcglobal:cbv:mda#streetAddressTwo">Room
378</attribute>
                                  <attribute id="urn:epcglobal:cbv:mda#city">Washington</attribute>
                                    <attribute id="urn:epcglobal:cbv:mda#state">DC</attribute>
                                      <attribute id="urn:epcglobal:cbv:mda#postalCode">12345-
6789</attribute>
                                        <attribute id="urn:epcglobal:cbv:mda#countryCode">US</attribute>
                                      </VocabularyElement>
                                    <VocabularyElement id="urn:epc:id:sgln:0614141.00000.0">
                                      <attribute id="urn:epcglobal:cbv:mda#name">GS1 Drug Distro
LLC</attribute>
                                        <attribute id="urn:epcglobal:cbv:mda#streetAddressOne">230 Park Ave
S</attribute>
                                          <attribute id="urn:epcglobal:cbv:mda#city">New York</attribute>
                                            <attribute id="urn:epcglobal:cbv:mda#state">NY</attribute>
                                              <attribute id="urn:epcglobal:cbv:mda#postalCode">10003-
1502</attribute>
                                                <attribute id="urn:epcglobal:cbv:mda#countryCode">US</attribute>

```

```

        </VocabularyElement>
      </VocabularyElementList>
    </Vocabulary>
  </VocabularyList>
</EPCISMasterData>
</extension>
</EPCISHeader>
<EPCISBody>
  <EventList>
    <ObjectEvent>
      <eventTime>2014-04-05T10:11:12Z</eventTime>
      <eventTimeZoneOffset>-05:00</eventTimeZoneOffset>
      <epcList/>
      <action>OBSERVE</action>
      <bizStep>urn:epcglobal:cbv:bizstep:receiving</bizStep>
      <disposition>urn:epcglobal:cbv:disp:in_progress</disposition>
      <readPoint>
        <id>urn:epc:id:sgln:0614141.00000.0</id>
      </readPoint>
      <extension>
        <quantityList>
          <!-- In this example, the EPCIS quantityElement data structure contains the
lgtin for the lowest saleable unit (LSU) and the quantity value is given in terms of LSUs. For
this example scenario, each ordered case contains 12 LSUs. Hence, the quantity value will be
computed by multiplying the order case quantity with 12 LSUs. -->
          <quantityElement>
            <epcClass>urn:epc:class:lgtin:030000.0000001.L1</epcClass>
            <quantity>120</quantity>
          </quantityElement>
        </quantityList>
        <sourceList>
          <source
type="urn:epcglobal:cbv:sdt:owning_party">urn:epc:id:sgln:030000.000000.0</source>
        </sourceList>
        <destinationList>
          <destination
type="urn:epcglobal:cbv:sdt:owning_party">urn:epc:id:sgln:0614141.00000.0</destination>
        </destinationList>
      </extension>
    </ObjectEvent>
  </EventList>
</EPCISBody>
</epcis:EPCISDocument>

```



## Proprietary Statement

This document contains proprietary information of GS1 US. Such proprietary information may not be changed for use with any other parties for any other purpose without the expressed written permission of GS1 US.

## Improvements

Improvement and changes are periodically made to publications by GS1 US. All material is subject to change without notice. Please refer to GS1 US website for the most current publication available. Although GS1 publications may, where appropriate, consider or address applicable statutory and regulatory requirements, such requirements are subject to change by implementing government agencies, and GS1 cannot guarantee that its publications will reflect all current statutory and regulatory requirements.

## Disclaimer

Except as may be otherwise indicated in specific documents within this publication, you are authorized to view documents within this publication, subject to the following:

1. You agree to retain all copyright and other proprietary notices on every copy you make.
2. Some documents may contain other proprietary notices and copyright information relating to that document. You agree that GS1 US has not conferred by implication, estoppels or otherwise any license or right under any patent, trademark or copyright (except as expressly provided above) of GS1 US or of any third party.

**THIS PUBLICATION IS PROVIDED "AS IS" WITHOUT WARRANTY OF ANY KIND, EITHER EXPRESS OR IMPLIED, INCLUDING, BUT NOT LIMITED TO, THE IMPLIED WARRANTIES OF MERCHANTABILITY, FITNESS FOR A PARTICULAR PURPOSE, OR NON-INFRINGEMENT.** You are solely responsible for determining the appropriateness of using this publication and assume any risks associated with your use thereof, and GS1 US does not represent or warrant that the guidelines in this publication are appropriate for your particular company or your particular applications, products or processes. Any GS1 US publication may include technical inaccuracies or typographical errors. GS1 US assumes no responsibility for and disclaims all liability for any errors or omissions in this publication or in other documents which are referred to within or linked to this publication. Some jurisdictions do not allow the exclusion of implied warranties, so the above exclusion may not apply to you.

Several products and company names mentioned herein may be trademarks and/or registered trademarks of their respective companies. GS1 US does not, by promulgating this document on behalf of the parties involved in the creation of this document, represent that any methods, products, and/or systems discussed or recommended in the document do not violate the intellectual property rights of any third party. GS1 US has not performed a search to determine what intellectual property may be infringed by an implementation of any strategies or suggestions included in this document. GS1 US hereby disclaims any liability for any party's infringement of intellectual property rights that arise as a result of any implementation of strategies or suggestions included in this document.

This publication may be distributed internationally and may contain references to GS1 US products, programs and services that have not been announced in your country. These references do not imply that GS1 US intends to announce such products, programs or services in your country.

## Limitation of Liability; No Liability for Consequential Damage

In no event shall GS1 US or anyone else involved in the creation, production, or delivery of the accompanying documentation be liable for any direct, indirect, special, incidental, or consequential damages of any character whatsoever (including, without limitation, damages for loss of business profits, business interruption, loss of business information, loss of goodwill, work stoppage, or other loss of any kind) arising out of the use of or the results of use of or inability to use such documentation, even if GS1 US has been advised of the possibility of such damages.

## IAPMO

In this publication, the letters "U.P.C." are used solely as an abbreviation for the "Universal Product Code" which is a product identification system. They do not refer to the UPC, which is a federally registered certification mark of the International Association of Plumbing and Mechanical Officials (IAPMO) to certify compliance with a Uniform Plumbing Code as authorized by IAPMO.



---

**GS1 US Corporate Headquarters**

Princeton Pike Corporate Center, 1009 Lenox Drive, Suite 202  
Lawrenceville, NJ 08648 USA  
**T** +1 937.435.3870 | **E** info@gs1us.org  
[www.gs1us.org](http://www.gs1us.org)

**Connect With Us**



6 14 14 1 02273 1